



Facilities for diagnostic imaging and interventional radiology

HBN 6

NHS
Estates

Facilities for Diagnostic Imaging and Interventional Radiology

HBN 6

London: The Stationery Office

NHS
Estates

© Crown copyright 2001

Published with the permission of NHS Estates,
an Executive Agency of the Department of Health,
on behalf of the Controller of Her Majesty's Stationery
Office.

Applications for reproduction should be made
in writing to:

The Copyright Unit,
Her Majesty's Stationery Office,
St Clements House,
2-16 Colegate,
Norwich NR3 1BQ.

ISBN 0-11-322553-9

First published 2001

*Cover photograph: Example of a cardiac X-ray biplane
imaging system. Image supplied by IGE Medical Systems.*

The area of diagnostic imaging is currently undergoing great change, with hospitals becoming more and more reliant on the use of digital imaging techniques.

There is a requirement to create adaptable facilities, in order to meet the pace of clinical and technological development, not only in patient diagnosis and treatment, but also in many other aspects of care and organisation.

Executive summary

BACKGROUND

This is the first major update on design guidance for Facilities for Diagnostic Imaging since 1991.

This document has been generated over a period of twelve months by a team of scientists and architects. Very wide and inclusive consultations with professionals, institutions and learned bodies have been undertaken. Radiologists, radiographers and imaging department managers were extensively consulted, each producing contributions or reports and now incorporated into this guidance.

A steering group comprising broad representation from the NHS, DoH and industry guided the direction and content to ensure full relevance.

NHS Estates engineering consultants and consultations with industry helped formulate [Appendix 2, "Engineering Requirements"](#).

AIMS AND OBJECTIVES

This document is aimed at a broad audience and covers the subject from its clinical and operational roots through to the design and equipping of imaging departments.

The key role is to report on the built environment required to implement the planning, construction, commissioning and operation of a new or upgraded facility. This extends to improving the built environment in which care is delivered, so as to promote efficiency and raise service quality.

NHS Estates has sought to employ innovation in the built environment, advancing the modernisation of diagnosis and treatment, in order to provide an environment that is genuinely sympathetic to the needs of all users and recognises the broad range of activities present and their significance.

OVERVIEW OF THE SUBJECT

The area of diagnostic imaging is currently undergoing great change, with hospitals becoming more and more reliant on the use of digital imaging techniques. However, a number of departments still continue to make use of more conventional technologies, at least for

the simpler examinations. Both approaches are therefore described throughout.

The intense sophistication of modern imaging diagnosis and treatment, coupled with the need for continuing advance, has shaped the structure and content of the document. The built environment today should liberate professional care providers to move forward to best techniques and practices. Many of the best techniques and practices are taken from the NHS Plan and the National Service Frameworks. There is also a requirement to create adaptable facilities, in order to meet the pace of clinical and technological development, not only in patient diagnosis and treatment, but also in many other aspects of care and organisation.

The use of interventional radiology procedures is recognised, as is the overall impact that this has on the built environment. Such procedures now make up almost 15% of the total workload of many diagnostic imaging departments.

THE PATIENT EXPERIENCE

The technological nature of diagnostic imaging and interventional radiology can often be an unpleasant and distressing experience for patients and their carers. It is of the utmost importance in designing facilities that the patient experience is taken into account. The emphasis should be on providing a pleasant and comfortable environment for patients at all times.

STRUCTURE

The guidance is broken into two parts.

In the first part the document builds from introductory sections describing possible imaging approaches, that is, conventional, part digital or fully digital. It then deals with each of the major imaging modalities considering policy, clinical and scientific matters, describes the patient journey and associated care protocols, and uses these to inform the design process for the built environment.

Appendices include text on the specialist engineering requirements, example plans and a full glossary of terms including some basic clinical descriptions. A supplement

examines the built environment implications of fully digital solutions and how they may affect the design of facilities and their relationships to other parts of the hospital.

The second part of the guidance is due to be published in late 2001. It will look at the department as a whole and examine planning relationships between modalities and other areas of the hospital in much more detail. Consideration will also be given to the provision of services at all three levels of healthcare. The guidance will be supplemented with a section on Tertiary Diagnostic Imaging and Interventional Services.

KEY NHS ESTATES DOCUMENTS OF RELEVANCE TO IMAGING SERVICES

This work is constructed against a sliding scale of environment specialisation. Those rooms or areas devoted entirely to imaging services are described in detail. However, those used incidentally for such care, together with common areas are simply listed and the reader is directed to other publications as appropriate.

Notable among these are:

- Health Building Note 22, 'Accident and Emergency Department in an Acute General Hospital';
- Health Building Note 15, 'Accommodation for pathology services';
- Health Building Note 29, 'Accommodation for pharmaceutical services';
- Health Building Note 40, 'Common activity spaces', Volume 2, 'Treatment areas';
- 'Facilities for cancer care services' (forthcoming);
- Health Building Note 26, 'Operating Department facilities'.

Acknowledgements

NHS Estates would like to thank the following individuals and their teams for their contributions to the construction and writing of this publication.

In particular we would like to acknowledge the role of members of the radiographer supporting and guidance sub team listed below:

Mark Viner, College of Radiographers Representative, Radiology Services Manager, St Bartholomew's and Royal London NHS Trust, Sub Group Chair
Claire Sims, Superintendent Radiographer in MRI, Addenbrooke's Hospital, Cambridge
Judith Elford, Superintendent Radiographer in Angiography and CT, Royal Free Hospital
Kalpana Patel, Superintendent Radiographer in Ultrasound, Great Ormond Street Hospital
Craig Forrester, Radiology Services Manager, Royal United Hospital, Bath

Great Ormond Street Hospital, London

Rosemary Dennett, Radiology Services Manager
Margaret Hindley, Nurse Planning Officer

The Hammersmith Hospital, London

Professor David J. Allison, Clinical Director of Radiology
Nuala O'Brien, Public Relations Officer
Dr Nicola Strickland, Consultant Radiologist
Dr Alastair Hall, MRC Clinical Magnetic Resonance Unit

William Harvey Hospital, Ashford, Kent

Paul French, Deputy Radiology Services Manager

Kent & Sussex Hospital, Maidstone & Tunbridge Wells NHS Trust, Kent

Dr Paul R Tallett, Clinical Director of Radiology

North Tees General Hospital, Stockton on Tees

Rob Dickerson, Radiology Services Manager

Newcastle General Hospital

Dr Keith Faulkner, Breast and Cervical Screening Manager

Mount Vernon Hospital and Watford Hospitals NHS Trust, North London

John Lowe, Superintendent Radiographer, Positron Emission Tomography Scanning Service

Guys and St. Thomas' Hospitals, London

Professor A. Adam, Professor of Interventional Radiology, St Thomas' Hospital
Dr J. Reidy, Consultant Radiologist, Guys Hospital
Stan Batchelor, Radiation Protection Advisor, Guys Hospital (nominated by the British Nuclear Medicine Society)
Dr Colin Lazarous, Lead Radiopharmacist, Guys Hospital

Leeds General Infirmary (LGI), Leeds

Dr Mike Weston, Consultant Radiologist, Ultrasound Department (nominated by the British Medical Ultrasound Society)

Basildon Hospital, Basildon, Essex

Mike Gille, Estates Manager

St George's Hospital, London's Radiology Department

Representatives from industry

Peter West, Service Manager South-East England, IGE Medical Systems
Chris Bull, Digital Imaging Applications Manager, Kodak Health Imaging
Malcolm Hart, Applications Manager, Philips Medical Systems
Ray Doddrell, Applications Sales Specialist, Siemens Medical Solutions

Department of Health

Steve Ebdon-Jackson, Head of Imaging Policy, Health Services Directorate

Principal authors:

Jason Britton, Assistant Scientific Advisor, NHS Estates
Stephen Wolstenholme, Senior Partner, Stanhope Wilkinson Architects

With contributions from:

Mr Ian Fraser, Consultant Engineer, Engineering & Science Group, NHS Estates
Mr Nigel Tomlinson, Chief Scientific Advisor, Engineering and Science Group, NHS Estates
Mr Gerald Stone, Project Manager

Contents

[Executive summary](#)
[Acknowledgements](#)

Introduction **page 3**

Purpose of the document
Context of the guidance
Intended audience
Legislative and policy context
Outline procurement procedures

Diagnostic imaging and interventional radiology services **page 10**

General
What makes up modern diagnostic imaging?
General patient journey
Professional staff groups and volunteers

Imaging approach **page 15**

Introduction
Procurement of film processing services
Image acquisition – conventional X-ray film processing
Image acquisition – part-digital approaches
Image acquisition – Computed Radiography (CR) – fully digital approach
Image acquisition – Direct Radiography (DR) – fully digital approach
Storing, handling and distributing images – conventional and part-digital
Storing, handling and distributing images – fully digital approach
Image reporting
Secretarial space and rooms
Multidisciplinary clinical case conference rooms

General X-ray imaging or radiography **page 37**

Introduction
Clinical and operational objectives
Patient journey
List of accommodation
Room and equipment descriptions
Unique operational requirements and facilities – special cases

Facilities for universal fluoroscopy and remote fluoroscopy systems **page 50**

Background
Clinical and operational objectives for universal and remote fluoroscopy/fluorography imaging systems
Patient journey
List of accommodation
Room and equipment descriptions

Fluoroscopy equipment for vascular and non-vascular imaging and interventional procedures **page 59**

Introduction
Clinical and operational objectives
Patient journey
List of accommodation
Room and equipment descriptions
Associated specialised engineering requirements
Mobile fluoroscopy equipment and the requirements for operating theatres and other environments – special case

Specialised angiographic systems for cardiac applications **page 69**

Background and introduction
Clinical and operational objectives – adults
Patient journey – adults
Patient journey – paediatrics
List of accommodation for tertiary centre provision
Room and equipment descriptions

Radionuclide imaging facilities based on gamma (Anger) camera systems **page 76**

Background and introduction
Clinical and operational objectives
List of accommodation and location of radionuclide imaging facilities
Room and equipment descriptions
The radiopharmacy
Mobile gamma camera – special case

Positron Emission Tomography units without cyclotron provision **page 90**

Background and introduction
 Clinical and operational objectives
 List of accommodation and location of PET facilities
 Room and equipment descriptions

X-ray mammographic imaging **page 94**

Background and introduction
 Patient journey
 List of accommodation for X-ray mammography
 Room and equipment descriptions

Ultrasound imaging **page 101**

Background and introduction
 Clinical and operational objectives
 Patient journey
 List of accommodation and location of the ultrasound suite
 Room and equipment descriptions
 Special cases

Computed Tomography **page 108**

Background and introduction
 Clinical and operational objectives
 Patient journey
 List of accommodation for CT
 Room descriptions and location of CT

Magnetic Resonance Imaging **page 118**

Background and introduction
 Clinical and operational objectives
 The patient journey and the concept of magnetic controlled area and safety principles
 List of accommodation and facilities for whole body imaging suites
 Room and equipment descriptions
 Siting requirements and control of radiofrequency (RF) radiations

Mobile vehicle scanning units to include CT/MRI and PET **page 133**

Background and introduction
 Sequence of events
 Site specifications
 Service requirements
 Special considerations for MRI scanners
 Special considerations for mobile vehicle X-ray, CT and PET scanners

Ancillary patient accommodation **page 139**

Reception areas
 Patient journeys
 Waiting areas
 Separate male and female changing areas – changing cubicles
 Counselling and private consultation rooms
 Patient entertainment and refreshment facilities

Staff and special activity accommodation **page 141**

Office accommodation
 Superintendent/Senior Radiographer accommodation
 Education facilities
 Staff location system
 Telephones and intercom systems
 Clocks
 Auxiliary areas for clean and dirty utility, trolley lay-up and associated nursing functions
 Patient call systems
 Staff emergency call systems
 Staff rest rooms
 Staff changing rooms including surgical scrub, shower and WC facilities
 On-call/night duty radiographer facilities
 Porters' base

Appendices

- 1 – Example plans** **page 145**
2 – Engineering requirements **page 183**
3 – Glossary of terms, abbreviations and further information on clinical techniques **page 209**
4 – References **page 221**
-

About NHS Estates **page 226**

1 Introduction

PURPOSE OF THE DOCUMENT

1.1 This document provides guidance for the design of diagnostic imaging and interventional radiology facilities and services. The provision of diagnostic services at primary care level is recognised, as are differences between tertiary and secondary level healthcare providers. A wide range of design options is covered, with discussion of factors that will inform selection of the most appropriate option.

1.2 In the majority of sections, no previous knowledge is assumed and references are provided for further reading if required. A glossary of terms is also included in the appendices. Where there is crossover or inter-linking with existing work published by NHS Estates or other Department of Health agencies, this is indicated. Potential effects on the built environment are noted and appropriate references provided. Notable examples of such crossover are the implications of clinical and policy guidance on cardiology and oncology.

The patient experience

1.3 The technological nature of diagnostic imaging and interventional radiology can often be an unpleasant and distressing experience for patients and their carers. It is of the utmost importance in designing facilities that the patient experience is taken into account. The emphasis should be on providing a pleasant and comfortable environment for patients at all times.

Inclusions

1.4 The following content is included in this guidance:

- this introductory chapter, which explains the purpose of the guidance and its context in terms of previous guidance, and within legislation and policy guidance. It also introduces the reader to options for procurement strategies;
- Chapter 2 introduces the reader to the subject and highlights some of the main issues when designing new diagnostic imaging facilities;
- Chapter 3 describes the possible approaches for acquiring, storing and transferring diagnostic images. The last nine years have seen the wide scale introduction of digital imaging modalities and digital

technologies including the widespread use of personal computers. Virtually all departments make use of some form digital image communication and storage, possibly coupled with plain film acquisition. Thus, the effects on the built environment of both conventional and digital approaches are discussed and compared. Some comparison of digital and conventional approaches is also made in the later sections describing the built environment requirements for the modalities;

- in Chapters 4 to 13 each of the main imaging modalities, together with associated built environment and design requirements, is discussed in turn. The order and grouping of the modalities is similar to that represented in [Diagram 1](#). For each modality, the following is presented:

- (i) background and introduction;
- (ii) clinical and operational objectives for the modality or equipment, particularly where this has direct impact on the built environment;
- (iii) the patient journey, which reflects the pathway from initial referral to exit from the department;
- (iv) a list of the rooms that should be provided to install the equipment and support the diagnostic imaging procedures. Where there is the possibility of sharing facilities with another modality, this is indicated;
- (v) room and equipment descriptions for the modality. In the majority of cases this incorporates an outline discussion of the options available and how they impact in the built environment;
- (vi) special cases;

(Under each chapter, a clear attempt is made to link the clinical objectives with the design of the built environment and incorporate any relevant imaging policies and legislation where this is appropriate.)

- Chapter 14 describes mobile diagnostic imaging services provided in an articulated vehicle. This chapter contains built environment information pertaining to the support of mobile imaging services. The focus is on MRI, CT and PET, with some

information on cardiac imaging services also supplied. The provision of mobile mammography, to support breast screening services, is recognised by the authors and the built environment requirements for this service will appear in updated versions of this guidance;

- Chapters 15 and 16 focus on ancillary accommodation for both staff and patients, particularly for those areas that are common between modalities.

1.5 In addition, an engineering requirements appendix has been included. This describes general engineering requirements and details of any special requirements for each of the modalities. Other appendices included in this guidance demonstrate example plans, schedules of accommodation and a glossary of terms.

1.6 This publication forms the first part of NHS Estates' diagnostic imaging and interventional radiology guidance for design and construction of new facilities.

1.7 The second part, due to be published by NHS Estates in 2001, will focus on the holistic hospital planning issues and the effects of differences between primary, secondary and tertiary care. Information on environmental factors, such as those concerned with ionising radiation, will also be a focus of the second part of the guidance. Some information on these issues is provided in Part 1, but the majority of the detail will appear in Part 2.

1.8 NHS Estates' intention is to provide a comprehensive design database for those professionals involved in the provision of new diagnostic imaging services.

Exclusions

1.9 This document does not give guidance on:

- teaching facilities. Where teaching facilities are to be provided, a separate case may need to be made for the cost of any additional accommodation needed for trainee radiologists or radiography students. The Royal College of Radiologists and the Joint Validation Committee of the College of Radiographers and the Council for Professions Supplementary to Medicine should also be consulted at the initial planning stages for any diagnostic imaging facilities where it is envisaged that radiologists and student radiographers will be undergoing training. However, where the teaching of medical students and radiographers has an impact on occupancy factors, for example, then this is noted in the text under the individual modalities. The majority of hospitals will be involved in the tuition of healthcare professionals connected with diagnostic imaging at some level, working in conjunction with established academic institutions;

- radiotherapy and oncology treatment facilities, including those with unsealed radioactive sources or substances, external beam radiotherapy and brachytherapy. Further information for this area can be found in 'Facilities for cancer care centres'. However, the diagnostic imaging facilities required in order to support Calman-Hine initiatives are referenced in this guidance and noted where appropriate.

CONTEXT OF THE GUIDANCE

1.10 This guidance is one of the first three from NHS Estates, the others concerning cardiology and cancer services guidance, that will try to demonstrate clear links between the design of the built environment and other factors, such as clinical work, the technology, the regulatory framework and policy. Previous documents have tended to focus directly on the built environment with only a small amount of information on the technology, clinical work and relevant policies. Because of the complexity of such projects, it is recognised that successful provision of new diagnostic imaging services requires the wide range of skills of a multidisciplinary team. The new guidance, therefore, is structured to assist a broad range of healthcare professionals in fully contributing to the provision of new diagnostic imaging services, whether this concerns single pieces of equipment in an established department or an entire modern diagnostic imaging department within a new hospital.

1.11 The guidance contains a number of descriptions of clinical procedures that are undertaken in a diagnostic imaging department. The descriptions are directly related to the use of the equipment and how this impacts on patient care. Providing the reader with comprehensive lists is not the intention. Rather, the information is included so as to provide some background knowledge. Where a clinical procedure has a very direct impact on the built environment and is important to patient care then this is carefully described and noted.

1.12 There is a considerable degree of regulatory framework that is relevant to diagnostic imaging because of the use of ionising radiations, for example in X-ray examinations. Worth mentioning at this stage are:

- the 1999 Ionising Radiations Regulations, which are principally concerned with the protection of staff working with Ionising Radiations;
- the 2000 Ionising Radiation (Medical Exposure) Regulations, which are principally aimed at the protection of the patient;
- the 1993/2000 Radioactive Substances Act, which is primarily concerned with the safe use of radioactive substances.

1.13 In addition, these acts and regulations are supported by codes of practice and guidance notes published by the Health and Safety Executive and the National Radiological Protection Board. The regulatory framework needs to be considered at an early stage of design of the Diagnostic Imaging department or the integration of new items of equipment or modalities.

1.14 Policies and changes in healthcare practice are described not only where they are considered to be part of diagnostic imaging, but also where those in other areas may have a direct impact on the provision and location of diagnostic imaging. In the latter case, changes in the structure of healthcare under the 1997 White paper, 'The New NHS: modern, dependable', may see the management of diagnostic imaging services alter considerably, particularly as new primary care trusts gradually become established over the next five years.

1.15 All of the above factors, clinical, policy, regulatory and technological, are integrated into the description of the built environment. Detailed room descriptions are provided and supported by appropriate illustrations, specialised and general engineering requirements and example plans of the different modalities, which include supporting accommodation necessary to provide proper care for the patient. The provision of an ergonomic built environment to support the staff working in the department is also strongly recognised. This is the most important part of the publication and the majority of text is focused on this area.

Why is the new guidance required?

1.16 Since the last document (Health Building Note 6 – 'Radiology department') was published in 1992, the whole area of diagnostic imaging has advanced considerably. The last 10 years have also seen the introduction of a number of new techniques and the rise of diagnostic imaging machines or modalities, such as MRI and ultrasound, to the point where they are now considered an essential part of providing a modern diagnostic imaging department or service. The medical field of diagnostic imaging is continuing to advance at an almost exponential rate, which is evidenced by the publishing of over 100 clinical and technical journals on the subject of radiology or diagnostic imaging worldwide per month. Clinical innovations and research undertaken in the healthcare practices of North America, Japan and Europe provide the content for these journals. The area of diagnostic imaging is almost continually changing, so designers, architects and healthcare professionals have a duty to provide a modern adaptable built environment that provides the best quality care for the patient.

1.17 The last nine years have also seen the rise of the use of interventional radiology on a much wider scale, both in tertiary and secondary care, where it now accounts for almost 15% of the procedures undertaken

in diagnostic imaging departments throughout the UK. Interventional radiology can be best described as the use of imaging to guide minimally invasive surgical procedures. In some instances, it has replaced some of the equivalent surgical operations, as the techniques involved are considered to put the patient at less risk and provide a faster pathway to an eventual cure.

1.18 Changes have also taken place in the regulatory framework, which has been updated with the new 1999 Ionising Radiations Regulations following the 1996 Euratom Basic Safety Directive and replacing the 1985 Ionising Radiations Regulations. The 1997 Euratom 97/43 directive on 'Patient safety and the use of Ionising Radiations' has been incorporated into the 2000 Ionising Radiation (Medical Exposure) Regulations. These regulations revoked the Ionising Radiation (Protection of Persons Undergoing Medical Examination or Treatment) Regulations 1988, commonly referred to as the POPUMET regulations.

1.19 There is an increasing demand for diagnostic imaging and interventional radiology treatment procedures and it is anticipated that this trend will continue in the future. Technological advances and innovations in imaging may produce changes in radiological methods, but it is unlikely that these will significantly affect the increasing need. Diagnostic imaging services now have a greater role in the total management of the patient, involving consultation, diagnostic procedures, discussion and treatment. There is now far greater emphasis on the use of multidisciplinary teams to diagnose and treat patients. A well-designed and planned diagnostic imaging department is essential if patients are to be investigated and treated speedily and efficiently as part of the overall treatment pathway.

1.20 The use of digital technologies has increased considerably since the last health building note publication. It is now possible to acquire successfully and reliably all types of diagnostic images using digital techniques, from the simple X-ray examination to the more complex examinations. This has been further supported by the development of computer communication, networking and workstation technologies, so that diagnostic images can be relayed from one location to another without the use of X-ray film. The initial costs of undertaking this change in working are considerable, both in terms of staff acceptance, training and procurement of the equipment. For this reason, a number of hospitals have implemented a part-digital approach, rather than choosing to make an immediate transition to a fully digital communication infrastructure. This is represented in the guidance and compared to the built environment requirements for conventional film processing approaches.

History of previous Health Building and Health Guidance Notes

1.21 This guidance supersedes or encapsulates the following:

- Health Building Note 6 – ‘Radiology department’, 1992;
- Health Building Note 6 – Supplement 1 – ‘Accommodation for Magnetic Resonance Imaging’, 1994;
- Health Guidance Note – ‘Magnetic Resonance Imaging’, 1997;
- Health Equipment Note 6 – ‘Radiodiagnostic department’, 1982.

INTENDED AUDIENCE

1.22 The document is aimed at advising the following healthcare professionals on the options available for designing and providing diagnostic imaging facilities in trusts and at primary care level. A representative from all these professionals could be involved in the design process:

- estates and facilities professionals including:
 - hospital estates managers;
 - hospital electrical engineers;
 - facilities managers;
 - project managers;
 - hospital estates consultants;
- architects working for and contracted to the NHS;
- superintendent and senior radiographers;
- radiologists;
- GPs and primary care trust/group chief executives;
- general hospital managers, in particular those managing surgery and diagnostics;
- nurses working in the diagnostic imaging department.

1.23 Additionally, suppliers and original equipment manufacturers may find this guidance helpful.

LEGISLATIVE AND POLICY CONTEXT

Diagnostic imaging policies and guidance

1.24 A number of sets of advice, guidance notes and publications on good clinical and organisational practice have been produced by the Royal College of Radiologists (RCR) and the Institute of Physics in

Engineering and Medicine (IPEM) with direct reference to diagnostic imaging policies. Some of the more pertinent publications, which probably have a direct effect on design of the built environment, are listed below. The websites of these societies and institutions for further reading are listed in [Appendix 3](#):

- ‘Making the best use of a department of Clinical Radiology. Guidelines for Doctors: Fourth Edition’. The advice is published by the Royal College of Radiologists and provides advice to referring clinicians as to the most appropriate examinations and procedures for their patients;
- ‘Retention of X-ray films: Resumé of the issues’. This publication, also from the RCR, gives advice to departments on the length of time X-ray films should be stored following the completion of an examination;
- IPEM Report Number 41 contains guidance on the shielding aspects of diagnostic imaging rooms and the type of materials that can be used. Although the guidance is primarily aimed at physicists, this may form a useful source of information.

1.25 The British Institute of Radiology (BIR) also publishes standards and guidance on the provision of diagnostic imaging services. Probably the most important to those involved in the building and construction of new facilities are the following:

- ‘Radiation Shielding for Diagnostic X-rays’ – Report of the joint BIR/IPEM working party. The text is primarily aimed at physicists but may be useful to design and construction professionals;
- ‘Justification in Radiation Protection’. The title of the guidance is one of the three basic principles of radiation protection established by the ICRP and the principles are embodied in the new Ionising Radiations Regulations 1999.

1.26 A number of policies have also recently been formulated by the Department of Health. Of these, the most pertinent are:

- evaluation of guidelines for access to diagnostic facilities;
- appropriate diagnostic facilities and new technologies. This document looks into the most appropriate location of diagnostic imaging facilities.

Key NHS Executive and Department of Health Agency policy initiatives

1.27 A number of policies and national frameworks are emerging in acute medical areas such as oncology and cardiology. The guidance states the way in which treatment should be delivered effectively and

appropriately to patients diagnosed with these pathologies, and describes how diagnostic imaging and interventional radiology services should be configured to best support these areas:

- 'The NHS Plan: A Plan for Reform; A Plan for Investment', published July 2000. The implications of the National Plan for imaging departments are described below;
- 'A policy framework for commissioning cancer services': a report by the Expert Advisory Group on Cancer (the Calman-Hine Report); the primary policy initiative in the provision of cancer services in England and Wales is described in the Calman-Hine Report. For a brief description, the reader is referred to the NHS Estates guidance 'Facilities for cancer care centres'. For the full text, please refer to the Calman-Hine policy guidance. A number of trusts are making progress towards achieving the goal of meeting the requirements of Calman-Hine by using the cancer collaborative initiatives (<http://www.doh.gov.uk/cancer/>);
- the National Service Framework for the treatment of coronary heart disease, which is briefly detailed in NHS Estates' guidance 'Facilities for cardiac services', although the facilities for undertaking cardiac angiography imaging and interventional procedures are described in detail in this diagnostic imaging guidance.

1.28 In addition, pilot studies are being undertaken to investigate the potential of diagnostic screening programmes, for example in preventing colon cancer, utilising X-ray fluoroscopy facilities, and strokes, using ultrasound imaging. However, the Department of Health Imaging and Oncology policy groups are not considering configuring new nationwide screening programmes over and above those already implemented. Before such action would be considered, the results from the initial pilot schemes described above will have to be quantified and clearly evidenced that there are benefits for overall patient care and positive economic revenue consequences.

The NHS Plan

1.29 One of the three major priorities for the NHS Plan dated 27 July 2000, is to improve the diagnosis and care delivery for cancer patients. General radiography will be one of the diagnostic modalities used to support this objective. This may require an increase in the number of installations and improvements in the built environment to support good general radiographic practice. A further description of the NHS Plan in respect of facilities for cancer care is given in the NHS Estates guidance 'Facilities for cancer care centres'.

1.30 Additional monies are being allocated for the procurement of 200 new Computed Tomography (CT) scanners. 150 of these will be to replace existing scanners and the other 50 units will permit additional procedures to be undertaken. The 150 replacement units will all have spiral scanning capabilities will be used to replace all the existing single slice and early spiral units within the UK, of which the majority are now coming to the end of their useful life.

1.31 The money for the new CT scanners is being provided through the New Opportunities Fund (NOF), which has been set up and operated through the Department of Health. One of the primary roles for the new scanners will be in the diagnosis and treatment planning of cancer patients and part of their total scanning capacity will be used to support radiotherapy treatments by 25 additional linear accelerators. It is probable that some of the new CT units will be located within a Cancer Centre, since they will have to be dedicated for the diagnosis and staging of cancer, together with Radiotherapy Treatment Planning (RTP). The New Opportunities Fund is being co-ordinated by the Department of Health Imaging Policy Group based at Wellington House.

1.32 The Calman-Hine work and subsequent policy initiatives, such as the NHS plan, have focused on the need for MRI as part of the overall holistic approach to the care of the patient. As a direct result, the plan contains specific targets for MRI provision in the NHS. Further to this, NOF will provide an additional 50 MRI scanners, the majority of which are themselves concerned with the functions, related to cancer, listed in the brief outline above. It is very likely that MRI provision will continue to be a major focus of government initiatives in cancer services broadly.

1.33 The facilities and equipment are to be procured at different phases, with the last tranche being undertaken by 2004. All of the equipment will be used to support major initiatives such as cancer, heart disease and renal services.

Legislative requirements

1.34 In this guidance, reference is made to provisions and facilities that are controlled by legislation, either in the form of Acts of Parliament or Regulations. Some parts of this legal framework incorporate UK Codes of Practice which are mandatory in their application, whilst others are derived from European Union Directives that have been incorporated into UK health and safety legislation. In providing diagnostic imaging services, the NHS has, therefore, a duty to comply with a considerable body of statutory and other requirements, the majority of which are mandatory. There is considerable legislation, codes of practice and guidance associated with the use of Ionising Radiations and these

are outlined in paragraphs 1.35–1.43. For example, all employers are required to register an X-ray generator with the Health & Safety Executive before making any use of the equipment.

1.35 Many of the current regulations, codes of practice and guidance notes are derived from scientific evidence and reports published by the International Commission for Radiation Protection (ICRP), to which employees of the National Radiological Protection Board (NRPB) make a significant contribution.

1.36 NHS service providers have, in addition, a duty to comply with a variety of procedures established by the Department of Health and other government agencies and departments such as the National Radiological Protection Board. They should also implement or make alternative arrangements for compliance with advice and recommendations contained in non-statutory but Approved Codes of Practice, such as those approved by the Health and Safety Executive or others with express responsibility for safety.

1.37 Finally, healthcare service providers have a responsibility to consider and, where appropriate, take account of guidance from a wide range of bodies, including the NHS Executive, learned organisations and European and international groups.

1.38 With respect to healthcare practices undertaking any form of procedure involving ionising radiation, they will need to appoint a radiation protection advisor (RPA), who maybe internal or external to the organisation and a radiation protection supervisor (RPS), who will assist in the implementation of advice from the RPA. Their roles and responsibilities are briefly described below.

1.39 The radiation protection advisor (RPA) is usually a physicist and holds certificates of competence in radiation protection. He or she has a duty to ensure that trusts are made fully aware of their responsibilities under current legislation and guidance notes, and to provide up-to-date advice on ionising radiation and, in some cases, non-ionising radiation. The RPA has also the responsibility to provide advice on safe working and visiting arrangements for staff and patients and undertake risk assessments in each of the diagnostic imaging rooms and associated areas. Estates professionals can call on the RPA for general and specific design advice on new and upgraded diagnostic imaging facilities. RPAs may use the most up-to-date scientific evidence available, which may be tighter than existing legislation. Virtually all suppliers of diagnostic imaging equipment will seek RPA approval before installing their equipment in new or upgraded facilities or starting any pre-installation works.

1.40 The radiation protection supervisor (RPS), who will usually be a senior radiographer or departmental manager, will usually work with the RPA in the implementation of their advice and ensure safe and effective day to day running of the department or facility. Each department will have a designated RPS, who will work directly for the hospital. They will also have a responsibility to ensure that all documentation such as maintenance reports and QA checks are kept in orderly manner and up to date. The advice of the RPS should also be sought early in the design stage, as they will be able to provide advice on ergonomics, occupancy factors and certain elements of radiation protection that may have an impact on the design.

1.41 While this document takes account, as far as is possible, of all statutory and other requirements and guidance and current scientific thinking in force or available at the time of publication, health care practices are reminded of their overriding duty to ensure compliance with all relevant statutory instruments and established procedures. It is also their responsibility to ensure that due weight and consideration is given to relevant guidance.

1.42 General advice on compliance is given in HC(88)60/HC(FP)(88)29.

Acts and Regulations

1.43 Where items of advice contained within this document are in support of Acts or Regulations, this is clearly indicated. With respect to ionising radiation there are currently to four acts and regulations which will probably have a direct impact on the design and planning of a diagnostic imaging and interventional radiology department. These are the 1999 Ionising Radiations Regulations, the Ionising Radiation (Medical Exposure) Regulations 2000, the 1993/2000 Radioactive Substances Act, and Regulations on Transportation of Radioactive Substances.

Summary

1.44 The effect of legislation, codes of practice and guidance notes upon each element of facility design or engineering dealt with within this publication is clearly explained.

1.45 It should be noted that there are currently no acts or regulations in place to cover non-ionising radiation. The use of non-ionising radiation in medical practice should adhere to the guidance notes produced by government agencies and the National Radiological Protection Board.

1.46 A list of the majority of regulations, statutory requirements and guidance notes in relation to diagnostic imaging equipment is given in Appendix 4.

OUTLINE PROCUREMENT PROCEDURES

1.47 There are now a number of methods and procedures that NHS organisations can follow to procure new facilities and equipment. These are traditional capital purchase using the Capital Investment Manual, and PFI and PPP procedures, which involve working with a commercial company as part of the team. As part of any procurement exercise the healthcare organisation may opt for design and build turnkey arrangements or full turnkey arrangements. These options are briefly described below. It should be noted however that if a trust opts for a PFI or PPP route, this should demonstrate both patient care and economic benefits above those that would be brought by a Capital Investment Manual approach. No matter what type of procurement method is chosen, multi-disciplinary teams from the healthcare provider should work closely with potential suppliers from a very early stage of the project to ensure a successful outcome. The project detail should not be left entirely in the hands of the supplier PFI/PPP partner.

Capital Investment Manual

1.48 The Capital Investment Manual is the mandatory procedural framework governing, inception, strategic and financial approach, procurement method, planning, processing and control of individual health building schemes. The aim is to promote a consistent and streamlined approach to capital development that achieves best use of resources through the selection and construction of relevant and cost-effective schemes that open on time and within budget. It identifies the main activities and provides a framework for delegation with effective management and the proper accounting for expenditure and performance.

Private Finance Initiative (PFI) and Public-Private Partnerships (PPP)

1.49 These policies and initiatives from the Department of Health describe how trusts and hospitals can obtain monies from private organisations to procure the fabric and large items of capital equipment either by using operating and finance lease agreements (PFI) or by forming financial partnerships with commercial organisations (PPP). Because the equipment forms the majority of the cost of the facility, this can present the organisation with a number of options in the procurement exercise.

1.50 The PFI or PPP agreement can be constructed to allow the equipment to be upgraded at regular intervals defined in the agreement, thereby providing some degree of future proofing in what is a fast moving area of technology and clinical innovation. In this respect the PFI or PPP agreement can also contain clauses related to the improvement of the built environment and the construction or altering of new or existing facilities. This

can be particularly important when trusts are moving from conventional processing techniques to digital acquisition methods, where the archiving, review and reporting strategies in play are completely different.

Design and build turnkey arrangements

1.51 Diagnostic imaging equipment, together with the associated building works, are frequently procured under single point contract arrangements, whereby NHS trusts enter into a contract with an equipment supplier to supply a fully functioning installation. The X-RAM trade association holds details of UK registered equipment suppliers and working agreements. As well as the supply of the diagnostic imaging equipment the contract will include building works in the form of extensions and/or alterations that may extend well beyond the diagnostic imaging room. This building work is typically undertaken by specialist design and build sub-contractors and may include the provision of temporary facilities as required. The contract is likely to include long-term maintenance agreements for the diagnostic imaging equipment, but typically not for the fabric and upkeep of the building. Financial arrangements for such contracts may vary and could take the form of either a direct capital payment or longer-term finance arrangements.

1.52 Careful pre-planning in turnkey arrangements by the trust is advisable for a successful project. For example, such pre-planning should include indicative layouts, room data sheets and explicit equipment specifications coupled with clinical targets and guidance on safety issues including radiation protection advice from the RPA and hospital wide fire safety policies. It may also be advisable to secure preliminary statutory approvals for, for example, planning and building regulations approvals where appropriate.

Full turnkey arrangements (design, build, finance and operate)

1.53 This is similar to the above, except that the equipment and buildings may be supplied and operated by a finance organisation, who will sub-contract all the services to manufacturers. In this arrangement, the trust may procure a whole service from the organisation including maintenance of the building and, in some cases, the financial organisation will provide the staff and consumables to operate the facility. The facility either remains in the ownership of the bank under an operating lease arrangement, or ownership of the facility may transfer to the trust under a long-term finance lease agreement. The site on which the facility is constructed typically remains in trust ownership and will be leased to the finance organisation on a peppercorn lease arrangement. In a peppercorn lease arrangement the trust may pay the supplier small amounts of money over the lifetime of a 25-year-long lease agreement.

2 Diagnostic imaging and interventional radiology services

GENERAL

2.1 The primary role of diagnostic imaging services is to support and serve other departments in a hospital or healthcare practice (for example, a general practice surgery) in providing diagnostics or treatment. Where imaging is used to guide a treatment procedure, this is referred to as interventional radiology.

2.2 Radiology or diagnostic imaging in its simplest sense is the use of X-rays and radioactive substances in the diagnosis of and treatment of disease. In recent years this definition has expanded to include the use of ultrasound and MRI in the diagnostic and treatment process. Neither of these techniques makes use of ionising radiation or X-rays, but of what is collectively known as non-ionising radiation. Diagnostic imaging is used in the identification of disease or, in some cases, to exclude disease. It is commonly used as part of a range of diagnostic tests, including the assessment of patient's symptoms, to form a diagnosis. Diagnostic imaging can provide images of human body structures such as organs and bones (anatomy) or of human body functions commonly referred to as physiology, or can be used as part of interventional radiology procedures.

2.3 The majority of diagnostic imaging procedures and examinations are still undertaken in the diagnostic imaging department. However, it may be appropriate to provide diagnostic imaging facilities in other areas of a trust or hospital, where this matches the expertise available, and does not conflict with accepted clinical practice and policies.

2.4 Patients, either in- or out-patients, will always attend for diagnostic imaging services for transient periods which may be quite brief, although exceptionally they may remain in a department for more than 8–10 hours continuously, where a sequence of examinations is required. Patients may attend for examinations and procedures on two consecutive days.

2.5 For many years there has been an increasing demand for diagnostic imaging and interventional radiology treatment procedures and it is anticipated that this trend will continue in the future with further technological advances and innovations in imaging. Diagnostic imaging services now have a greater role in the total management of the patient, involving

consultation, diagnostic procedures, discussion and treatment. There is now far greater emphasis on the use of multidisciplinary teams to diagnose and treat patients. A well-designed and planned diagnostic imaging department is essential if patients are to be investigated and treated speedily and efficiently as part of the overall treatment pathway.

2.6 Effective designing and planning depends on full, early and continuing consultation with future users of the facilities. Attention should be given to any possible developments that could occur up to ten years in the future. Rooms should be planned for replacement of the equipment and not "shrink-wrapped" to suit the sizes and installation requirements of individual items of equipment. Equipment replacement cycles may be between five and ten years depending on modality. In addition, future changes in practice, such as an increased use of ultrasound and the number of interventional procedures undertaken, will have planning implications regarding the extra space needed for nursing preparation and support.

WHAT MAKES UP MODERN DIAGNOSTIC IMAGING?

2.7 Diagnostic imaging is made up of a range of imaging modalities. Full descriptions of the modalities are given in the text. Construction, layout and room height requirements will vary significantly between modalities, for example in the requirements for X-ray protection. The following is a list of modalities:

- a. general X-ray units including those facilities required for Accident & Emergency;
- b. mobile X-ray units;
- c. general fluoroscopy and fluorography apparatus for interventional and diagnostic imaging procedures
- d. mobile image intensifiers or c-arms devices;
- e. specialised fluoroscopic and angiographic facilities;
- f. radionuclide imaging;
- g. Positron Emission Tomography (PET);
- h. ultrasound imaging;

- j. X-ray mammography;
- k. Computed Tomography (CT);
- m. Magnetic Resonance Imaging (MRI);
- n. dental X-ray units – this modality will be described in future updates of this guidance;
- p. mobile diagnostic imaging services provided in an articulated vehicle. Virtually all of the modalities described above can be transported using, or permanently installed into, mobile vehicles. In some cases, for example MRI and CT units, this requires a large articulated vehicle. A number of companies provide mobile imaging services in the UK.

2.8 Although conventional X-ray imaging relied on analogue X-ray photographic film images, all of the imaging modalities can now be configured to produce images digitally (as digital data) and the inherent design of some modalities requires the acquisition of digital data, as is the case for CT and MRI. It is now possible to capture the data, store it digitally and transmit the information to other parts of a hospital or within the actual department itself. As a simple example, this would allow the same images to be viewed simultaneously and discussed by two clinicians in differing locations, which is usually not possible with conventional X-ray film acquisition. The digital networking infrastructure necessary to meet this operational requirement is called a Picture Archive and Communications System (PACS). The implementation of such a network can have real patient care benefits coupled with improved staff working conditions. The use of this technology also has profound implications for the design of the built environment and this is discussed in the PACS supplement (forthcoming).

2.9 PACS is not prevalent in most hospitals but the majority of diagnostic imaging departments do support some basic digital network communication between modalities and localised archives are becoming more common. The document supports alternatives to both conventional and digital imaging approaches and details its effect on design and the built environment.

2.10 Telemedicine, or more specifically, teleradiology will be described in the PACS supplement (forthcoming).

2.11 Bone densitometry techniques are considered to be beyond the scope of the guidance at this time, but a description of the built environment supporting this modality will appear in future updates.

Organisation of the imaging modalities

2.12 Modern diagnostic imaging can be further subdivided into a number of areas and this may reflect the overall organisation of equipment and imaging suites

in a new or refurbished department. In essence, diagnostic imaging can be broken into small clusters of imaging modalities and this is described in [Diagram 1](#).

2.13 [Diagram 1](#) demonstrates the main components that make up a Diagnostic Imaging and Interventional Radiology department. Not every room is represented in this schematic diagram, but it does show how some modalities and multiple suites can be planned close together, bringing benefits in patient care, efficient use of space by sharing some of the supporting rooms, good clinical communication and expertise sharing. The modalities circled with a dotted line are those that may be developed and used at tertiary level or specialist centres. This guidance is broken into these areas demonstrated in the diagram. The number of suites shown for each modality is for indicative purposes only and should not be used as a definitive guide. The number of suites actually required will depend on several other factors. The distances between the separate modalities and the general circulation areas should not be used in planning terms. Schedules of accommodation will be published during 2001.

2.14 [Diagram 2](#) shows how the Diagnostic Imaging and Interventional Radiology department could be planned to be adjacent to other areas of a hospital. A dotted line indicates a close but not essential relationship to another department or area.

2.15 The relationship with Accident and Emergency will depend on whether additional dedicated trauma imaging facilities are provided within the A&E department. This may be considered necessary in certain contexts to provide good patient care and access to diagnostic imaging in emergency situations. A&E departments require a good relationship with CT and general X-ray imaging.

2.16 There should be a good relationship with out-patient clinics, particularly those involved in treating orthopaedic patients, as orthopaedic related examinations may make up to three-fifths of the total examinations undertaken.

2.17 Planning should include a reasonably good relationship with antenatal clinics if the department is undertaking antenatal diagnostic ultrasound examinations. Planning should ensure that the radionuclide and PET imaging clusters are not close to the ultrasound suite of rooms.

2.18 The department should have a good relationship with the main entrance of the hospital and access to the department should be directly off the main hospital street on the ground floor of the hospital. This will ensure that out-patients and GP patients can locate the department relatively easily and facilitate the transfer of equipment to the department. Wide corridors and doors

DIAGRAM 1

Major components of a Diagnostic Imaging and Interventional Radiology Unit, together with suggested clustering

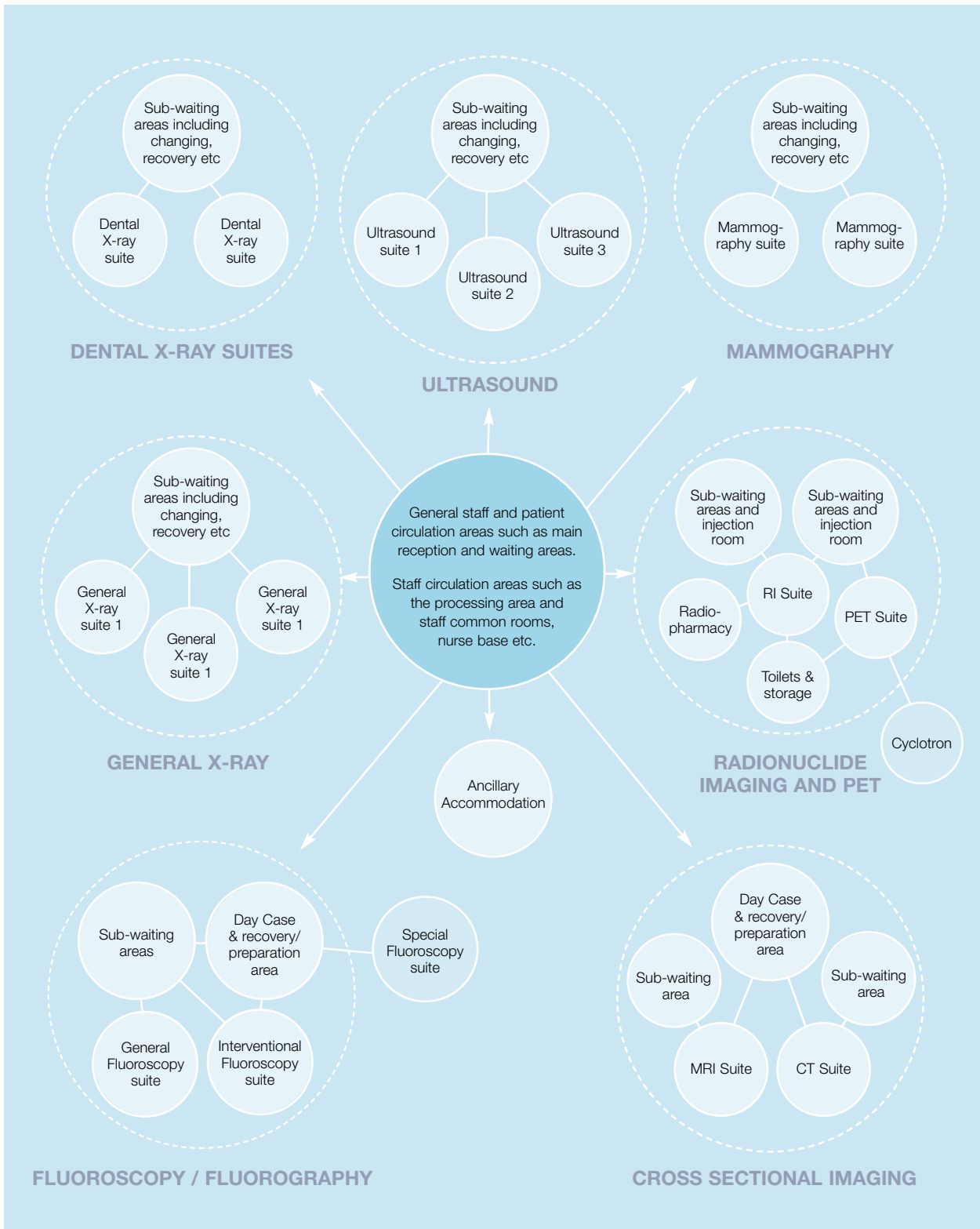

Please note that not all rooms are shown here and this should only be used as introductory planning material. The numbers of rooms indicated should not be used for planning purposes.

DIAGRAM 2

The outline relationship of the Diagnostic Imaging Unit to other areas of a hospital

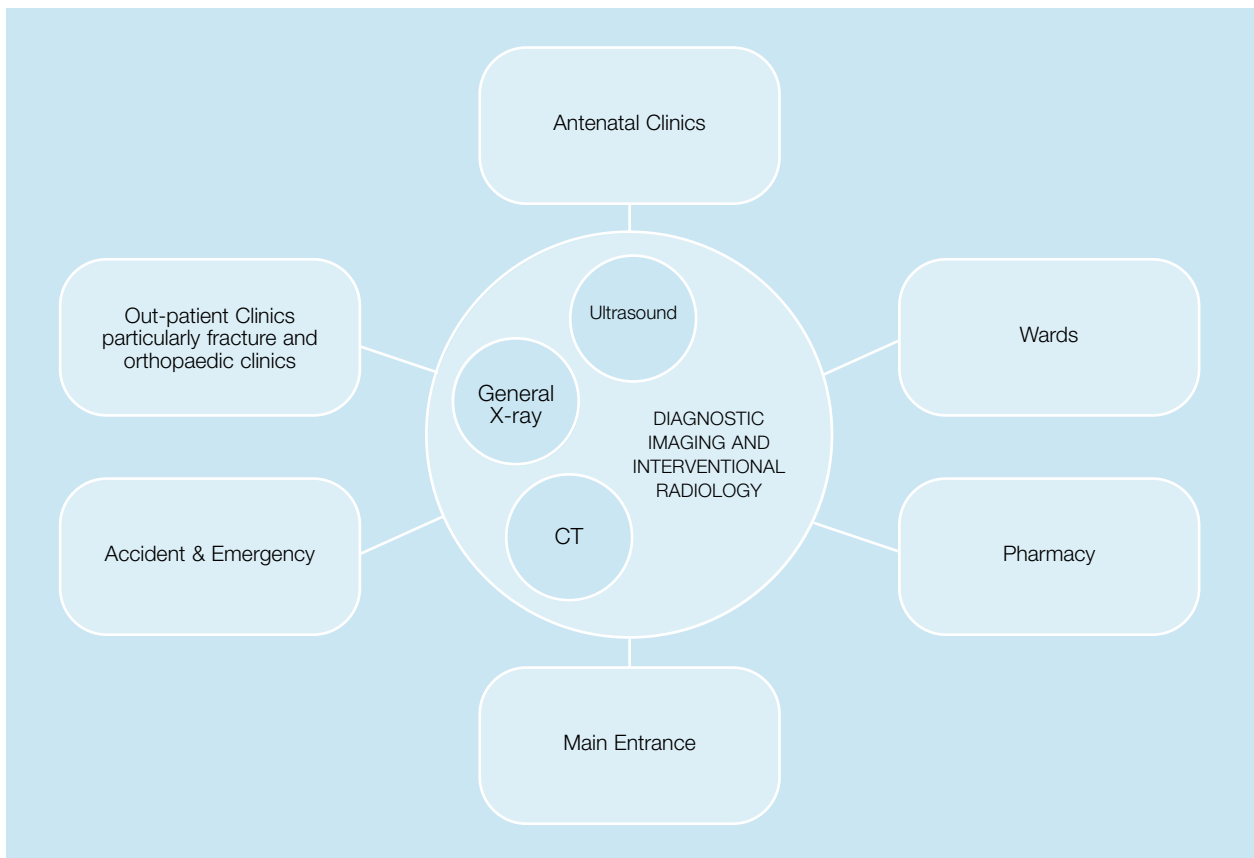

should be provided between the main entrance and the diagnostic imaging facilities to allow for the transfer of equipment.

2.19 The pharmacy department support will include the provision of sedative drugs and, possibly, contrast media. Radioactive substances will be required for some procedures and these will be supplied by a radiopharmacy, which may form part of a larger pharmacy department, or be provided separately as part of the diagnostic imaging department.

2.20 Ward areas may be relatively distant from the diagnostic imaging department. Ideally, the planning of circulation routes should allow for separate access by in-patients, who may be on beds or on trolleys.

GENERAL PATIENT JOURNEY

2.21 In a hospital, diagnostic investigations and procedures most appropriate to providing a diagnosis are selected by a clinician, often in consultation with a radiologist. Diagnostic imaging departments carry out investigations and report results as quickly as is reasonably practicable. In an acute general hospital, referrals are accepted from other departments in the

same hospital, from other hospitals and from primary health care and community health team doctors.

2.22 Patients will usually be referred to diagnostic imaging for an investigation by a clinician, who is required to provide a request form for examination/procedure. The request form will either accompany the patient or be sent prior to their attendance. The referring clinician should provide full patient details including clinical indications for the examination. Departments will only usually accept referrals once all the required information has been provided. One of the exceptions to this policy will usually be referral from Accident & Emergency, where some patients may require immediate access to diagnostic services.

2.23 Out-patients may be referred directly by their GP for a diagnostic imaging examination or procedure. Patients attending out-patient clinics may be referred directly for diagnostic imaging examinations. An example would be the referral of patients for X-ray examinations during fracture clinics. Alternatively, patients may be sent for a diagnostic imaging examination after medical appointment with a consultant or clinical specialist. Once the clinician has received the

report and had the opportunity to discuss the case further with medical colleagues, the patient may then make another appointment to discuss the results.

2.24 In-patients may be transferred from the wards for diagnostic imaging examinations and procedures on beds or trolleys. In some instances, the examinations may be undertaken in the ward area using mobile units, but the majority of hospitals have clinical policies which require patients to be transferred to the fixed or installed units wherever this is deemed clinically appropriate.

2.25 Where interventional treatment or imaging procedures are undertaken, then patients may attend on either as in-patients, or on a day case basis. In the latter case, they are admitted early in the morning, consent and preparation is undertaken, the procedure is undertaken mid morning to early afternoon and then the patient is allowed time to recover and then sent home. If complications develop the patient will be admitted as an in-patient. However, in the majority of cases, patients undergoing interventional treatment are admitted on the day of the procedure and remain as in-patients for one or two nights afterwards, to allow for recovery and check for complications.

2.26 Full descriptions of patient journeys are provided in the text below for each of the modalities.

PROFESSIONAL STAFF GROUPS AND VOLUNTEERS

2.27 The range of staff groups needed to support modern diagnostic imaging and interventional radiology has risen rapidly as the services provided have diversified and number of available techniques increased.

2.28 In modern diagnostic facilities the following staff groups may be present:

- radiologists, including consultants, senior registrars and house officers;
- radiographers working in all areas of a department;
- imaging room technicians and radiographer assistants;
- clerical and administrative staff, who may be involved in maintaining the film library or receiving out-patients upon arrival, for example;
- nurses, who may for example be assisting with interventional or barium procedures and caring for patients in specialised recovery areas;
- volunteers who may be assisting with the care of patients or helping with administrative duties such as moving films around the department or the hospital;
- radiography helpers.

2.29 Following recent closures of schools of radiography and the introduction of three and four year radiography degrees, there appears to be a shortage of qualified radiographers within the UK. This may see the introduction of imaging technicians, who will work under the supervision of radiographers and carry out relatively basic imaging techniques such as chest X-rays, and plain film extremity examinations. Such individuals will not be qualified to work in more specialised areas such as angiography, fluoroscopy, and CT. This may have the effect of increasing overall team sizes, thereby increasing some accommodation needs.

2.30 The role of senior radiographers in particular has also been changed over the last few years, where some members of staff have taken on roles traditionally undertaken only by radiologists. This primarily relates to conduct of barium X-ray examinations, which, in the majority of facilities, are undertaken by senior radiographers. In some cases, where training has been provided, radiographers are reading and interpreting X-ray films acquired from patients attending A&E outside core working hours. The purpose of this is to speed up the time taken to report the images acquired and thus improve patient care. These changes will have an impact on the built environment and provision of associated facilities such as offices.

3 Imaging approach

INTRODUCTION

3.1 This chapter reviews a number of potential methods of data collection and how this impacts on the built environment. It is broken down into three parts and these are outlined below.

3.2 The first part of the chapter briefly reviews the methods of procurement for image processing services.

3.3 The second part of this chapter describes in general the different methods for acquiring the images in a diagnostic imaging and interventional radiology department.

3.4 The third part of this chapter describes how the acquired images are collated, sorted, distributed and eventually stored.

3.5 The chapter is designed to encompass all imaging modalities listed in the sections above. There are three approaches to acquiring and distributing the images and these are briefly described below:

- a. fully conventional approach: this is where images are captured and processed using conventional X-ray film. The images would be acquired in general X-ray rooms, mammography and during some parts of the examinations in conventional and remote fluoroscopy systems. The film would require processing in shared, almost adjacent, areas. The facilities and equipment to undertake this approach are outlined, together with any special built environment implications. The facilities required for distributing the X-ray films for reporting, review and archiving are detailed. These require a large allocation of space within the hospital or department/facility;
- b. part digital approach: in this instance the data acquired from the modality is inherently digital. This is particularly true for images acquired using MRI, CT, angiography and fluoroscopy. If the hospital has yet to develop the capacity to transmit the images digitally to other parts of the hospital or department for review and reporting, the data will need to be presented on film and this is achieved by the use of laser printing devices. Once the images have been reported they will require sorting, collating and distributing to other parts of the hospital as for

conventional acquisition and processing techniques. In this approach the department may maintain a copy of the images digitally on a local archive (CD-ROM, for example) and the facilities to support this are also described;

- c. fully digital approach: in this instance images will be acquired digitally including those from general X-ray rooms, stored using large digital CD-ROM archives and accessed by clinicians working anywhere in the hospital via a high speed network. This is a very basic description of a Picture Archive and Communication System (PACS), which would form part of an integrated hospital networking strategy. In this instance there may be no requirement for film sorting, collating and distribution areas. In practice, the fully digital approach is difficult to achieve, as not all the modalities can acquire digital images of sufficient clinical quality and there may be times when the hospital still has to transfer images to a film based format, particularly when distributing them to nearby hospitals. In this instance space needs to be allocated for machine rooms housing the large CD-ROM archives. There is a much more detailed description in the PACS supplement (forthcoming).

3.6 The approach used to acquire the images will have an impact on how they are viewed and reported by clinicians and radiologists within the department. The methods and their effect on the accommodation required are described in the last part of this chapter.

3.7 The chapter is summarised by three workflow patterns, which directly compare the three approaches.

3.8 In general, diagnostic imaging departments are gradually moving towards a fully digital solution for the storage and distribution of diagnostic images. This trend is likely to reduce future dependence on conventional X-ray film development and storage, and should be taken into account when planning projects. However, departments making the transition from film based to digital radiology will still need to provide facilities to cater for both, and allow for the possibility that departments may still need to view old films, or revert back to conventional imaging during breakdowns, even when the transition has been completed.

PROCUREMENT OF FILM PROCESSING SERVICES

3.9 Project teams should investigate capital and partnering agreements with potential suppliers at an early stage of project development when tendering for recording media. Different manufacturers are likely to have different requirements in respect of space and services, which will need to be taken into account. The detailed design layouts should be sufficiently adaptable to facilitate later upgrading or replacement of the conventional processing equipment by alternative suppliers or by digital processing equipment.

Procurement strategies

3.10 The following procurement strategies can be utilised when tendering for the acquisition of either conventional or digital imaging equipment described in the three approaches put forward below:

- a. capital procurement of the equipment and recording media, such as film cassettes, from revenue budgets;
- b. a simple finance arrangement, where the hospital owns the equipment at the end of the lease. The hospital would either pay for the recording media through the finance lease or using their revenue budget;
- c. an operating lease arrangement, where the capital equipment remains in ownership of the supplier. This is the most favoured of the options under a PFI agreement. The hospital pays rent on the equipment to the supplier or pays higher rates for consumables such as film or, in the case of computed radiography, a small fee for each image acquired. In the latter cases, the supplier usually specifies minimum quantities over a fixed term contract, in order to cover the loan of the equipment. This arrangement would usually be part of a partnership agreement, where the trust only purchases image recording consumables from a single company and, in return, the supplier would stand most of the risk on the equipment, which cannot usually be re-sold.

3.11 The last examples of operating and partnership arrangements can be extended to upgrade equipment periodically and assist in the transition from conventional to digital imaging acquisition methods and can include changes to the building design of the department.

IMAGE ACQUISITION – CONVENTIONAL X-RAY FILM PROCESSING

Accommodation required – the film processing and viewing area

3.12 The film processing and viewing area is typically a busy centre of activity for diagnostic imaging staff. In

addition to the activities describes below, it acts as an important focus for informal staff contact and professional review.

3.13 Activities undertaken here will include the following.

- the request forms from referring clinicians will be received by the department and this will drive the imaging process. The examination or procedure performed will depend on the details provided in the request form;
- the X-ray films will be processed by automatic processors, which require loading and unloading;
- initial viewing and checking of films will take place at a panel of wall-mounted X-ray viewers. Radiographers will check for technical quality and anatomical coverage;
- patient details will be checked at computer workstations connected to a computer/network-based Radiology Information System (RIS);
- the patient details will be transcribed to the completed X-ray films;
- administrative staff will usually sort and collate the films for clinical reporting and interpretation by radiologists elsewhere in the department;
- in some instances, the radiographer will identify films for close inspection or attention, possibly using a red dot system. This usually occurs where Accident & Emergency films are processed outside core working hours.

Number of film processors required

3.14 The accommodation required will be dependent on the number of film processors needed. As a general guide, a large diagnostic imaging facility should be provided with at least two automatic daylight film processors. To decide if more are required, the following factors should be considered:

- a. the maximum number of images acquired per hour from associated general X-ray imaging rooms and how this relates to the maximum number of films that can be processed per hour on a single daylight automatic processing unit. The majority of film processing is carried out using 45, 60 and 90 second processing cycles for all X-ray films;
- b. whether mammography films are to be processed using the same automatic film processors. This may be appropriate if low numbers of mammography films are produced, as there are problems in maintaining the developing and fixing chemistry if a dedicated unit is used to process small number of films;

- c. spare capacity during breakdowns, servicing, general maintenance and peaks in demand. To assess needs, project teams should examine the guaranteed uptime figures quoted by the manufacturer;
- d. the relative numbers of conventional and remote fluoroscopy rooms and whether the fluoroscopy equipment can produce images digitally and send these to a digital archive or a laser imager for printing;
- e. local requirements for the processing of OPG and panoramic dental films, if such facilities are provided in the department.

3.15 If film processing has to be accomplished 100% of the time over 24 hours, seven days a week in order to support A&E applications, strategies should be in place to avoid single points of mechanical failure and loss of service. Breakdowns and servicing may take out the operation of the film processor for between five and ten working days per year.

3.16 For small satellite departments, possibly serving one or at most two general X-ray rooms, a single automatic processor should be sufficient and this could be located in a darkroom, if there is limited space available.

Siting of the film processors and processing areas

3.17 The occupancy pressure in a processing area will vary dramatically with time and the number of imaging rooms located in the adjacent space. As an example, a processing area serving two general X-ray rooms will need to accommodate transiently up to six radiographers, nurses and radiologists and other clinicians at peak times as they move about the department and between the processing area and adjacent X-ray rooms.

3.18 The siting of the film processors must be considered in the context of local requirements and workload demands, and be arranged so as to reduce staff movement to a minimum. For example, a processing area may be located centrally to serve two or more adjacent general X-ray rooms. The overall policy should be such that alternative processing facilities are always available within a reasonable distance, thus ensuring that a processor breakdown does not affect operational requirements.

3.19 Processing areas should be sited adjacent to the staff entrances of all the X-ray rooms that are served. Within a larger diagnostic imaging department, the provision of two distinct processing areas should be considered to serve geographically separate groups of X-ray rooms. For example, one processing area could serve a group of general and A&E X-ray rooms, and a

separate processing area could serve fluoroscopic and other general X-ray rooms.

3.20 A separate processing area may be required to serve a cluster of dedicated A&E department general X-ray or other diagnostic imaging rooms. This may incorporate two or more automatic daylight film processors and laser printing equipment.

3.21 Example plans of processing areas and their relationship with imaging rooms are shown in Appendix 1.

Other considerations affecting processing area accommodation requirements

3.22 A processing area may also need to accommodate laser printing facilities for generating hard copy film images from digital imaging modalities. If several digitally based imaging modalities require hard copy printing, a server will be required to network the modalities, and sequence and control the printing of images by a wet or dry laser imager. A description of this equipment is contained in [Chapter 3 under "Image acquisition – part-digital approaches"](#).

3.23 In addition to general worktop and storage space and appropriately positioned film X-ray film viewers, purpose-adapted low-level open units will be required, with vertical dividers, for the local storage of film cassettes of various sizes. Space may be needed for transfer, by trolley, of completed films and patient records.

3.24 The processing and viewing area should be provided with a large sink for the routine cleaning of processor rollers; the size of the sink should be confirmed with the processor manufacturer.

Accommodation required – darkroom facilities

3.25 Although the use of daylight automatic processing is now commonplace, it is still recommended that darkroom facilities be provided. These facilities will be used for loading of film magazines, film copying and processing of non-standard sizes of film.

3.26 The darkroom facilities can also be used to provide an automatic darkroom processor, which can serve as a back-up function to the daylight automatic processors, during periods of downtime or when the daylight processor has problems unloading the cassette. In this case, the radiographer or assistant will unload the film from the cassette and place this in the automatic processor for developing. The cassette will be manually reloaded using film stored in the darkroom.

3.27 One arrangement is for a daylight automatic film processor to be installed, backing onto a small adjacent darkroom and built into the partition using light-tight

construction. This arrangement allows non-standard film sizes to be manually fed from behind into the automatic processor, with the “feed-in” side in a safe-lit area and the “output” end in the adjacent film processing and viewing area.

3.28 An alternative arrangement is to have a dedicated darkroom processor, positioned so that the “feed-in” end is in the safe-lit area and the “output” end in the adjacent processing and viewing area. In this situation, a larger darkroom will be required and there will be no facilities for the automatic unloading of cassettes.

3.29 Design of a darkroom may have to allow for desktop specialised processing requirements for intra-oral and bitewing dental films, which cannot usually be processed by standard automatic film processors used for other more conventional X-ray film.

3.30 Alternatively, in larger hospitals, where there is a high throughput of dental films, a dedicated floor standing unit located in a dark room may be required, in order that the films can be processed. Additional space will need to be allocated for this purpose.

3.31 When the door is closed; magazines and cassettes may be passed into the darkroom via a lockable light tight cassette hatch. A cassette hatch, where provided, should be fitted with interlocks to prevent white light entering the hatch when safe-light conditions are required.

3.32 The darkroom will require safe lighting (coupled to an exterior warning light), a white light, bench space for unloading and loading cassettes and for film QA tests, and cupboards for general storage.

3.33 A film copier, typically a free-standing or bench mounted unit approximately, maximum size, of a floor mounted unit, 1000 x 700 x 700 mm, is likely to be required and should also be located in the darkroom.

3.34 A light tight under-bench film storage hopper may be needed, depending on operational requirements. The extent of such storage will also depend on local working practices and the use of digital modalities such as CR and DR. Where provided, procedures should be put in place to prevent the film in the hopper becoming exposed to white light. The position of the storage unit should not face the entrance door to the dark room.

3.35 The darkroom door should be lockable and must totally exclude any ambient light from adjacent areas.

3.36 Extract ventilation should be considered, to provide negative air pressure in the dark room in order to reduce possible chemical contamination risks to the imaging staff. As an indication, between 12 and 15 air changes per hour should be provided. Please also refer to [Appendix 2, Engineering Requirements](#).

3.37 The darkroom should be located directly adjacent to the film processing area.

Accommodation required – unused film and chemical store

3.38 A dedicated room within the diagnostic imaging department should be provided for the secure storage of unused film and of processing chemicals, not necessarily adjacent to the film and processing area. Shelving should be provided in various depths to suit the sizes of film in use; the deepest shelf required is likely to be 450 mm. It should be sited away from X-ray imaging rooms or shielded from radiation and should be in a location with a ventilated and cool environment. Film storage provision should accommodate enough film for a maximum of six to eight weeks’ use, as film older than this may be susceptible to fogging. The weight of the film to be stored should be taken into account in the design and positioning of shelving. Natural daylight should be excluded from this area.

3.39 Normally, it is customary for departments to keep a four week supply of film, but contingency planning should allow a department to keep film for six to eight weeks, depending on operational policies.

3.40 Developing and fixing chemicals, typically up to 100 litres, should be accommodated on low level shelving or appropriate open floor space.

3.41 The temperature and environmental conditions, particularly humidity within the film store, should be kept within tolerances in accordance with film supplier recommendations.

Conventional film processing equipment

Films, cassettes and film handling

3.42 Films used in radiography consist of a base coated on both sides with an emulsion sensitive both to X-rays, and to light. To enhance the effect of the X-rays, the sheet of X-ray film is held in close contact between two surfaces known as intensifying screens. These fluoresce when exposed to X-rays, and the photographic emulsion is thereby exposed to both light and X-rays.

3.43 The intensifying screens are held with the film in a re-usable container known as a cassette. Films and cassettes are produced in a range of standard sizes; the largest cassettes in common use hold films of 35 cm x 43 cm.

3.44 The commonest way in which films are placed in position for exposure is by first loading each film into a light-tight cassette. Packs of unexposed films are taken from the unused film store and loaded into the automatic processing units or film loaders using magazines. Depending on the particular processing unit,

it may be necessary for film magazines to be loaded in a darkroom prior to transfer to the automatic film processor.

3.45 The automatic processor or film loader will place individual films into cassettes, ready for use in the imaging rooms. After exposure, the cassettes are returned to the automatic processor, where the films are automatically unloaded from the cassettes and chemically processed ready for viewing.

3.46 At all times before the completion of processing, films must be protected from exposure to light and from exposure to irradiation. Depending on local working practices, unexposed cassettes may also be held ready for use within the shielded area of the X-ray room or within the processing area.

3.47 Each film must be marked with particulars of the patient's identification, normally taken from request forms or the hospital's RIS. To do this, a patients records terminal is required in the processing and viewing area. In order to minimise the chances of error, this should be done before the film leaves the care of the radiographer.

3.48 The films are usually marked, following exposure, while still in the cassette prior to processing, by a photographic method, which is provided for in the construction of the cassette. This involves the use of a small actinic marker device, usually located separately in the processing area. An indicative size for such a marker device is approximately 400 x 400 x 400 mm, and the unit should be installed on a worktop close to the film processor.

3.49 Alternatively in some systems, the marking of patient details on the cassette may be carried out by the film processing unit itself, although a separate actinic marker unit may still be required for back-up purposes.

Daylight automatic film processing systems

3.50 Virtually all sizes of X-ray films can be processed using daylight automatic processing systems. Daylight automatic processing and film handling is so called because it can be undertaken in areas of natural daylight or artificial light by the use of light-proof film handling devices. A number of commercial daylight processing systems are available, with differing arrangements for re-loading and unloading cassettes. Most commonly, the unloading and reloading of the film cassettes, as well as the processing of film, are all undertaken in the one integrated floor standing unit. In this case, the radiographer will place the cassette in the unit, the exposed film will be processed and the cassette returned to the radiographer loaded with unexposed X-ray film. Integrated processors can handle the majority of film sizes used in a modern department.

Unexposed X-ray film is loaded into the processor by the use of magazines and this process is described above.

3.51 An indicative size for an integrated automatic processor is 200 x 100 x 100 mm (H x W x D). Manufacturers should be consulted for more specific detail. The service requirements for integrated and non-integrated film processors are outlined in the section below. The automatic processor will be able to handle a wide range of standard film cassette sizes, and special adaptations may be made for the processing of other sizes of film.

3.52 Alternatively, the reloading of cassettes may be separated from the other processing functions. This is particularly advantageous for handling large numbers of films quickly, for example in separate A&E diagnostic departments. The film loaders are typically wall and floor mounted, with an indicative size of 1800 x 600 x 250 mm (H x W x D) and a separate unit may be required for each film size. A separate daylight film processor will continue to be used but the footprint area of this processor will be similar to the integrated unit described above. This has far reaching implications for the design of the processing area, to ensure an efficient workflow and to ensure that loaded and unloaded cassettes do not become confused, resulting in empty cassettes being used for patient examinations (see [Figure 3.1](#)). It should be noted that, with improvements in the speed of integrated units described above and the emergence of digital technologies, this approach is becoming less common.

3.53 In both cases, project teams should assess the possible requirement for safe lighting, to allow for the retrieval of films in the event of breakdown of the automatic film processor.

3.54 The processing and viewing area should be provided with a large sink for the routine cleaning of processor rollers; the size of the sink should be confirmed with the processor manufacturer.

Supply of chemicals to automatic processors

3.55 Normally, separate automatic chemical mixers are used, which will open and mix packs of chemicals as required and give warning when further supplies are needed. These avoid the need for direct contact with the chemicals, reducing the risk of the technicians being splashed or inhaling vapours. Such mixers can serve one or more automatic film processors or wet laser imaging equipment within the same area or adjacent areas.

3.56 Automatic chemical mixers are typically floor standing; indicative dimensions are 1000 x 700 x 600 mm. Proposed suppliers should be consulted for

exact sizes. Mixers are typically located close to the automatic film processors, and require piped connection. [Appendix 2, Engineering Requirements](#) provides further details for chemical mixers and film processors.

3.57 Consideration should also be given to the possible recycling of fixer solutions.

Silver recovery

3.58 Please refer to [Appendix 2, Engineering Requirements](#).

IMAGE ACQUISITION – PART-DIGITAL APPROACHES

Conventional film processing with a digital storage option

3.59 At least one of the major photographic suppliers in the UK manufactures a single, integrated, automatic daylight film processor with a digitiser and digital storage device. The films are processed using an automatic processor as described above, but once processed, the films are digitised and the digital data stored on an associated optical CD-ROM disk archive. At the end of the process, the department still has a hard copy film record of the diagnostic investigation, but

has also acquired a digital version. This process has the advantage that if films are mislaid when sent to the wards or other clinicians for review, they can readily be re-printed from the digital archive via a separate laser imager. One disadvantage is that the image quality of the digital copies of mammograms acquired using these systems may not be appropriate for reporting purposes.

3.60 If the department has future plans to set up some form of PACS, this may form an appropriate intermediary step between conventional and digital technologies. A relatively dust-free operation is required for the operation of the digitiser, and room ventilation should be designed accordingly.

3.61 The digitiser is integrated with the actual processing unit, but it is customary to house the archive in another location in the diagnostic imaging department of the facility, for security reasons.

3.62 The combined film processors and digitisers are usually slightly larger in footprint area than the daylight automatic film processors and thus have greater space requirements. The throughput may not be as fast as images processed on a stand-alone daylight processor.

3.63 In all cases, more than one processor may be required in order to meet the processing requirements at

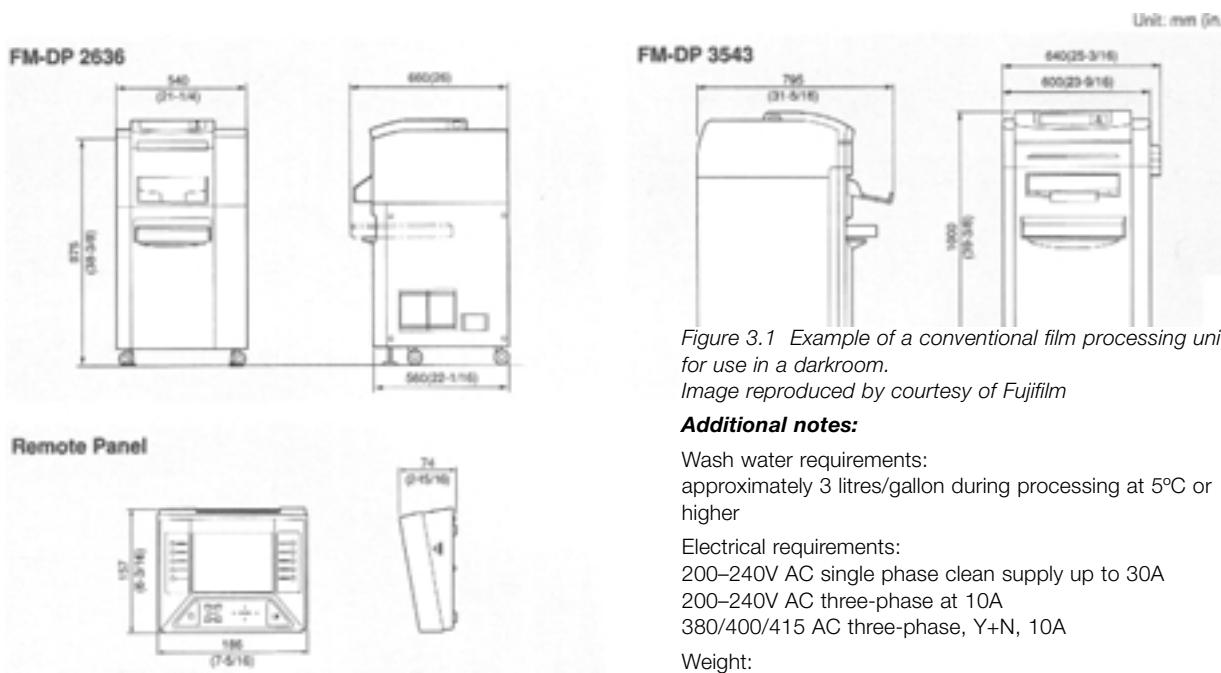

Figure 3.1 Example of a conventional film processing unit for use in a darkroom. Image reproduced by courtesy of Fujifilm

Additional notes:

Wash water requirements:
approximately 3 litres/gallon during processing at 5°C or higher

Electrical requirements:
200–240V AC single phase clean supply up to 30A
200–240V AC three-phase at 10A
380/400/415 AC three-phase, Y+N, 10A

Weight:
150 kg without solutions
180 kg with solutions

(Data will vary between manufacturers and should be checked before installation)

Figure 3.2 An example of chemical mixing device. (Image reproduced by courtesy of Fujifilm)

Additional notes:

Power requirements:
standard single phase 240V clean supply

Water supply:
approximately 4litres/minute at a pressure of approximately 8 kg/cm³.
Temperature between 5 and 30°C

Drain:
approximately 50 mm within 50 cm of the mixer

Ventilation:
adequate ventilation for the room must be provided of the order of 10–15 air changes per hour

Weight:
up to 100 kg fully chemicalised

Service access:
at least 60 cm to the front and one side of the unit. Allow approximately 20 cm to the rear of the unit. This may vary between manufacturers

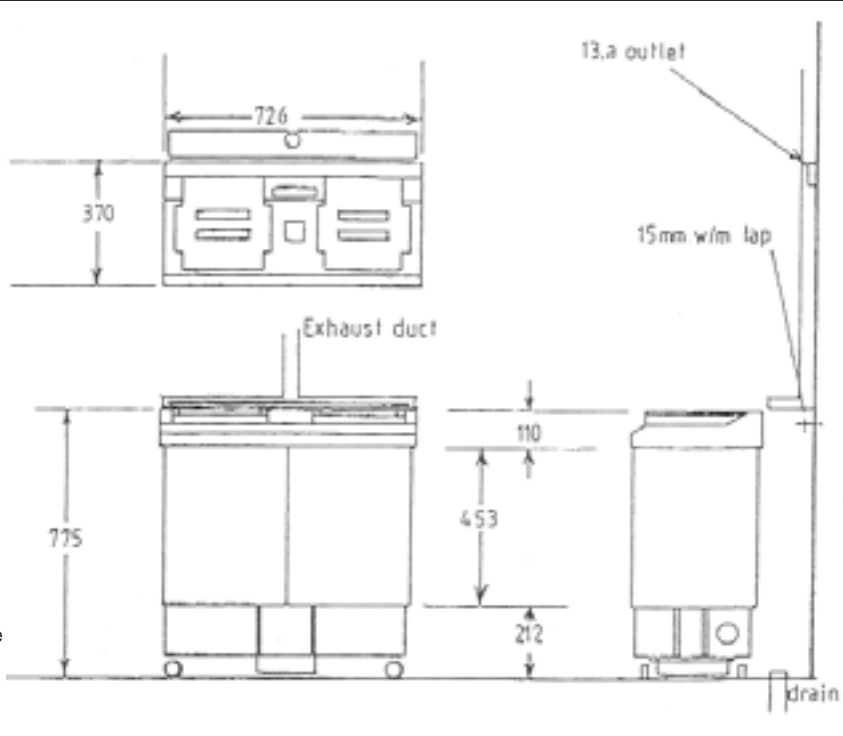

times of high demand and to cover breakdowns and planned maintenance. Ideally, this provision should take the form of two combined digital/processing units, or it maybe satisfactory in an interim situation to have a combination of a daylight processor with one of these types of units.

Other part-digital approaches

3.64 CR and DR offer alternative methods of data acquisition from the conventional approach described in the sections above. Both CR and DR can be used as a fully digital or part-digital approach, and are described in more detail below.

3.65 Other part-digital approaches occur where digital image data, acquired using modalities such as CT, MRI and angiography, is converted to hard copy film. These modalities are also appropriate for a fully digital approach, where infrastructure permits.

Equipment required for part-digital approaches

“Wet” laser printers

3.66 These printers take digital image data acquired using modalities such as CT, MRI and angiography and convert this to hard copy film. These films are similar in a number of respects to conventional X-ray film and are viewed using X-ray viewers. As for standard X-ray films, unexposed films should not be exposed to light or radiation. The printers may be hardwired via a separate network directly to the imaging modalities and possibly direct to the PACS network. Each modality will be

equipped with a suitable interface, which should be located adjacent to the control console.

3.67 Overall, the units are 1500 x 2000 x 800 mm (H x W x D). All service requirements are as for daylight automatic film processors and again these should be sited near a wall if possible.

3.68 The same film storage area for conventional X-ray film should be used for storing laser-imaging film. Chemicals and similar considerations as detailed above will apply. Film magazines for wet laser printers may need to be loaded in a dark room as for conventional film processors.

3.69 It should be noted that the use of this printing technology is now in heavy decline as dry laser printing units are now being procured in preference to these devices. Dry lasers do not require chemicals, resulting in easier installation requirements and lower running costs.

“Dry” laser printers

3.70 As for wet laser printers, these devices form hard copies of digital image data from modalities such as MRI, CT and CR. Unlike wet laser printers, there is only a requirement for an electrical supply. Although the composition of the film used is different from that used in conventional X-ray film processing, the resultant images are similar in appearance. These devices do not use developing and fixing chemicals and thus have no requirement for water supplies, chemical mixer units and waste drainage or specialised ventilation. There are no specific room requirements for the siting of dry laser printers, except that some may require a UPS or a 30A

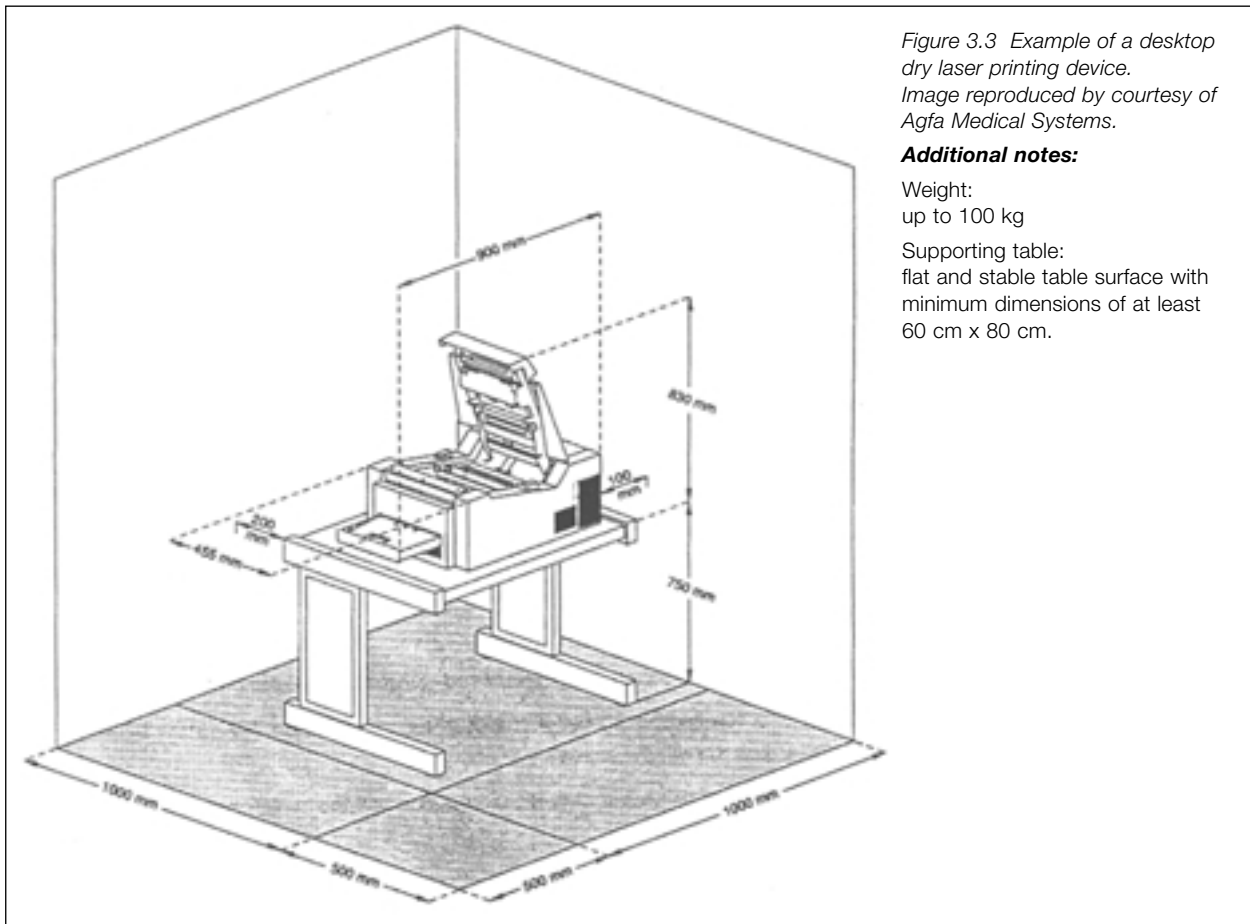

Figure 3.3 Example of a desktop dry laser printing device. Image reproduced by courtesy of Agfa Medical Systems.

Additional notes:

Weight:
up to 100 kg
Supporting table:
flat and stable table surface with
minimum dimensions of at least
60 cm x 80 cm.

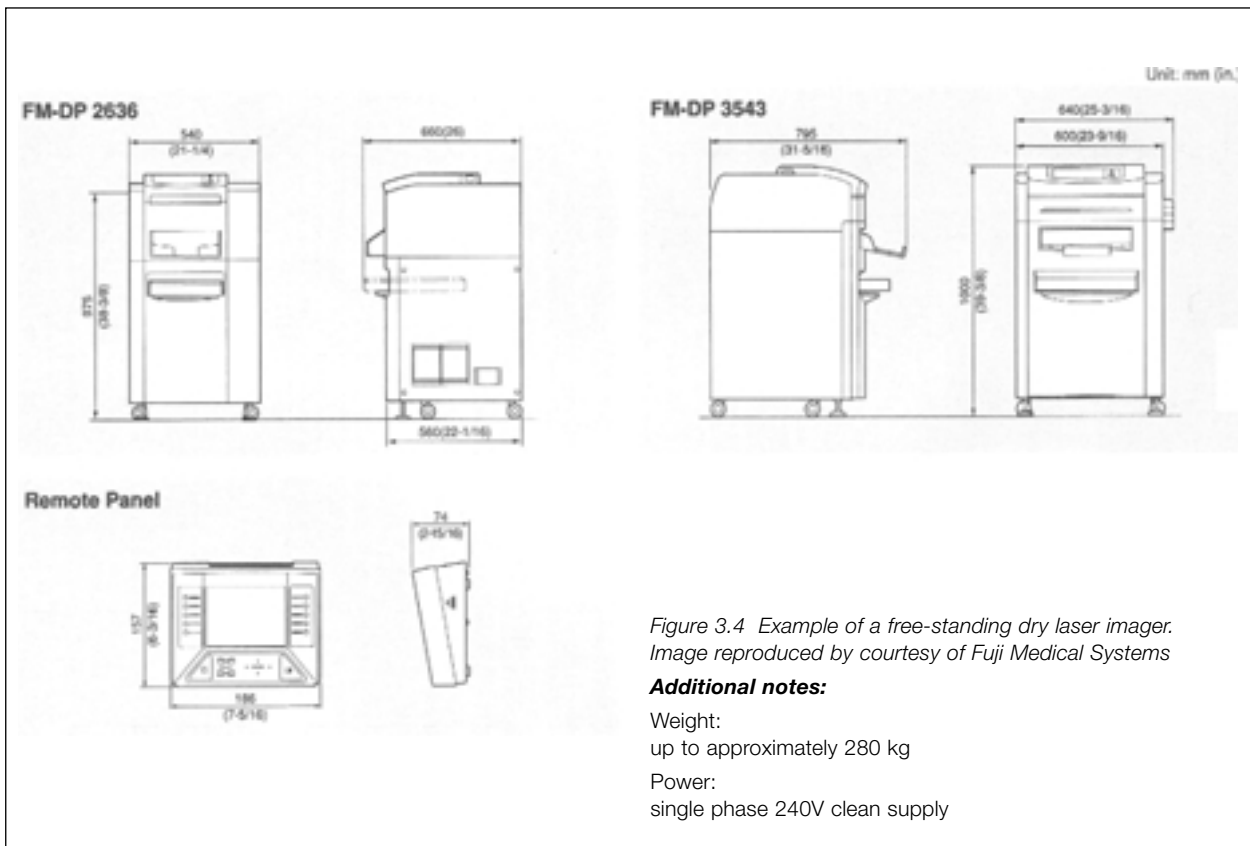

Figure 3.4 Example of a free-standing dry laser imager. Image reproduced by courtesy of Fuji Medical Systems

Additional notes:

Weight:
up to approximately 280 kg
Power:
single phase 240V clean supply

supply and the ambient room temperature and relative humidity values should not exceed manufacturers tolerance values. Exceeding the tolerance values may increase the periodicity of breakdown and repair. Provided these criteria can be met, they can be located in a number of areas to suit operational and workflow requirements.

3.71 There are two typical sizes of dry laser printers currently available. One is a floor standing type for printing 17" x 14" and 14" x 11" films, of the order of 1500 x 800 x 800 mm (H x W x D). A smaller unit, which because of its small size is customarily mounted on a worktop or bench, would usually be limited to printing 10" x 8" or, in some cases, 14" x 11" films.

3.72 Where they are used in combination with CR, they need to be conveniently accessible from general and conventional/remote fluorographic X-ray diagnostic imaging rooms. They can also be located in control areas for CT and MRI, or, in some cases, in ultrasound examination rooms. In this context, the waste heat output from the dry laser printer should be taken into consideration.

3.73 Storage space required for unused film, which is similar in a number of respects to conventional X-ray film, should be allocated for a maximum of 6 to 8 weeks' supply. Film for dry laser printers kept longer than this period may start to degrade. No chemicals need to be stored with the dry printing equipment or film. As for conventional X-ray film, dry laser printing film should be stored in conditions that are within manufacturers' tolerances and it must not be exposed to light or X-ray radiation.

3.74 Dry and wet laser printers may be used to serve a number of modalities via a separate printing network. An additional server may need to be located to act as a print spooler within the department or facility and can usually be connected to a maximum of two dry laser printers. It does not necessarily have to be located close to the laser printers, but this can be operationally advantageous when diagnosing faults and maintaining the printing network. The print server can form a large single point of failure and should therefore be fitted with a UPS device to protect it from spikes and surges in the local power supply.

3.75 The majority of modalities can be procured with a digital interface for connection with a laser imager, but there are still one or two manufacturers that provide an analogue output. In order to convert this to format which can be understood by a digital dry laser printer then this has to go through analogue to digital conversion and this is achieved by the use of a PACS link device. These devices need to be mounted on a shelf and be cabled as part of the printing or PACS network.

Solid inkjet printers

3.76 A number of photographic companies sell small inkjet printers for the production of hard copy film images from low resolution modalities such as ultrasound, MRI, radionuclide imaging and PET. They are relatively cheap and can be networked in a similar fashion to dry and wet laser imagers. However, the majority of units available can be installed on a desktop or bench and are of similar size to a small format dry laser imager.

IMAGE ACQUISITION – COMPUTED RADIOGRAPHY (CR) – FULLY DIGITAL APPROACH

Introduction

3.77 This is a digital process for acquiring plain X-ray film images and can be used as a direct alternative to conventional X-ray film, cassettes and processing. It can be used with a fully digital or part-digital approach. A CR system will consist of a plate reader, an identification terminal or PC and potentially a computer workstation depending on local operational requirements. No fundamental changes need to be made to the primary engineering or installation of general X-ray units with the exception of a re-calibration of the exposure characteristics of the X-ray unit.

3.78 Although CR is a current and developing technology it is likely that it will be superseded by Direct Capture Radiography or Direct Radiography (DR) over the next 10 to 20 years, as the reliability and image quality of this approach improves. The integration of this technology into a diagnostic imaging department is described below. The existing DR devices are not capable of undertaking non-bucky or cassette holder radiography, whereas those for CR are, but this may change dramatically with the advent of new devices that will be made commercially available over the following two to three years.

3.79 The accommodation requirements for CR are similar to those of conventional techniques, but in the majority of cases the processing area will need to be made larger to accommodate the additional equipment involved, such as the computer workstations and patient identification terminals. In addition, hospitals may procure multiple low throughput units to match the operational requirements of high throughput systems, thus avoiding single points of failure. This will further increase the accommodation requirements.

CR workflow and technology

3.80 In a number of respects the workflow characteristics in using CR technology are similar to that of film. CR image acquisition is described in [Figure 3.5](#).

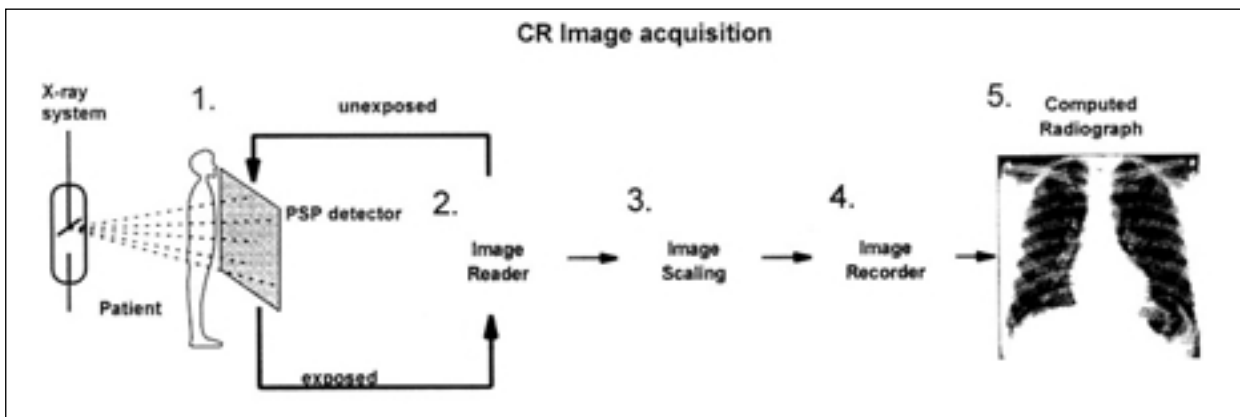

Figure 3.5 Example of a computed radiography image acquisition flow chart

3.81 Instead of using plain film as the image acquisition medium, re-usable photo-stimulable plates (referred to as a plate) are utilised. The plate is placed into a cassette, which is exposed to X-rays in a similar fashion to a cassette carrying plain X-ray film. The cassettes used have a similar appearance and are available in the same full range of sizes as those used in conventional film/screen radiography. The difference in CR is in how the image is acquired. The radiographer will select the appropriate patient details using the ID terminal. The ID terminal is directly linked to a CR plate reader. The cassettes are then placed in CR reader units where the imaging plate is automatically unloaded and then read using a scanning laser within the CR unit. The process of scanning the plate also “cleans” it and once completed returns it to the same cassette. The cassette is then ready for re-use. Processing speeds are slightly longer than for conventional modern automatic X-ray film processors. The image data and patient details are then matched by the system and displayed together. Example illustrations of CR plate readers are shown in Figures 3.6 and 3.7.

3.82 Unexposed and stored CR plates should not be exposed to light or radiation and are usually contained with the cassette except when processed. The storage

of cassettes and plate pairs is as for conventional film based systems.

3.83 The images are displayed for initial review or QA on monitors that are either incorporated within the actual CR reader units themselves or at another computer workstation nearby, linked by a network. Such a workstation may have storage capacity for about 5000 X-ray images. The computer workstation could be used to manipulate or improve the quality of the images acquired. The radiographer, once satisfied with the standard of the images produced, may then choose one of the following options:

- print the image acquired using a laser imager as described above. CR is a digital technology, which potentially allows integration in the filmless PACS system, but some hospitals may use CR to produce hard-copy film using a laser printer. These films will have to be stored as for conventional film. This approach may be taken when the hospital is moving from a film based to a digital environment;
- send it to a central archive as part of PACS system and subsequent reporting elsewhere;

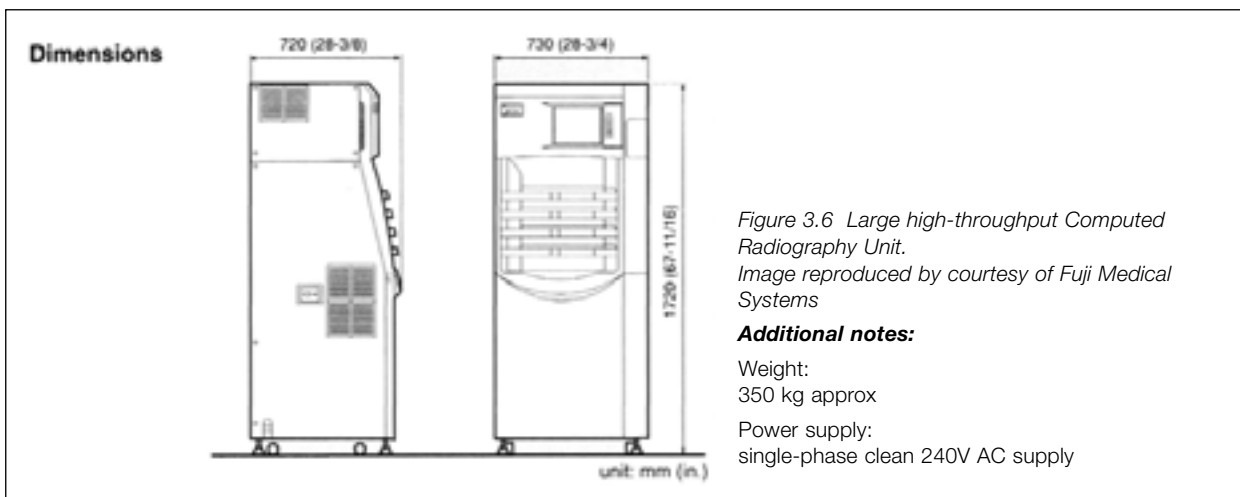

Figure 3.7 Low/medium-throughput Computed Radiography Unit.

Image reproduced by courtesy of Fuji Medical Systems

Additional notes:

Weight:

275 kg approx

Power supply:

single-phase clean 240V AC supply

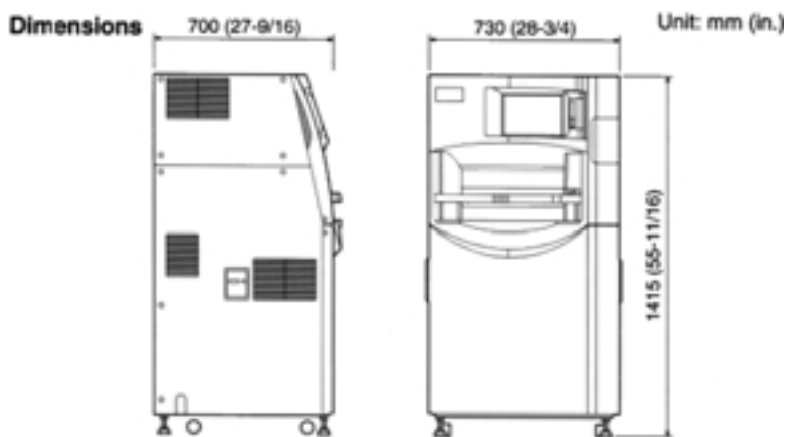

- send to a digital archive serving CR only, as part of a batch of images from the workstation's local storage unit.
- It should be noted that problems have been experienced in using the DICOM print protocol between CR and laser imagers from some vendors. Because of this, some hospitals are continuing to use the established Kodak EPA 952 protocol, but future networking developments should allow a move to the DICOM print standard as it becomes better defined.

3.84 Images may be saved to CD-ROM using a small CD writer attached to the workstation.

3.85 There may be a single review computer workstation serving each CR plate reader or, alternatively, a single review workstation may serve up to three CR plate readers. A single review workstation should be installed on dedicated benches within the processing area and would usually incorporate relatively large monitors. The computer review workstations usually form part of the PACS network and may have a separate connection the laser printing network, in addition to the one provided at the CR reader.

3.86 Some healthcare providers may wish to keep a conventional film processor to provide a back-up function to the CR system. This may take the form of darkroom processor or a low throughput daylight processor for example.

3.87 In deciding the number of units to be installed, all of the factors described for film processing above should be considered. The relationship to the overall operational requirements of the department should also be considered, for example whether the service is to be provided for 24 hours in order to serve an A&E department. One large unit may support the needs of a whole department, but breakdowns and servicing may mean that that unit is not working for several days per year. It may therefore be appropriate that multiple low throughput devices are used and networked, together with the computer workstations and ID terminals, to

form a CR segment. As an example, three 60 plate per hour CR readers and associated devices (eg computer workstations and identification terminals) will be needed to support a department having a peak demand of 180 films per hour and also requiring 24-hour support for A&E.

3.88 The radiographers physically transfer the CR cassettes from the X-ray rooms to the plate readers. The processing area should be planned to be in close proximity to and with direct access to the X-ray imaging rooms it serves. The planning of the processing room with respect to adjacent imaging rooms should be similar to that for conventional X-ray film processing.

3.89 One ID terminal is provided for each CR plate reader. This is comparable to a PC based system, and may be sited on a workbench, with parts of the unit mounted on a wall bracket adjacent to the CR plate reader. The ID terminals may be linked by a suitable interface to a RIS to allow for direct transfer of patient data to the CR segment.

3.90 Image data from fluoroscopy units and other X-ray modalities can be transferred using a network to the same computer workstation identified above for review, storage and analysis.

3.91 Depending on manufacturer and model, indicative sizes of CR plate readers vary between 1000 x 1000 x 1000 mm and 2250 x 2000 x 1000 mm (H x W x D). CR plate readers require electrical power only. Manufacturers should be consulted on appropriate operating temperature and relative humidity conditions. Mechanical ventilation of the processing room is likely to be required.

Special case

3.92 Some manufacturers are making available small low throughput CR plate readers, which are designed to be installed within the shielded control area of a general diagnostic X-ray imaging room. This may have major operational advantages for small and A&E units by

reducing staff movements and improving workflow. This is an emerging technology and not many examples have been installed in UK hospitals. A larger control area may be required in order to house the CR reader and associated computer workstation and ID terminal. Further information on the impact of this new technology is described under the section on general radiographic units.

Advantages of CR over conventional film techniques

3.93 The advantages of CR are:

- a. the re-take rate should be lower, as it is possible to manipulate the image's contrast characteristics once acquired using a review workstation. Where the plate has been over-exposed, there should no longer be a requirement to re-take the X-ray examination, as would be the case for conventional X-ray film. This has particular advantages when undertaking ward, ITU and Accident & Emergency examinations. A number of healthcare providers in the UK have already procured CR units specifically for use in A&E, ITU and ward radiographic applications;
- there is reduced requirement to use chemicals to generate images, although there may still be the facility for hard copy images to be printed using either wet or dry laser printers. In the latter case, there will no longer be a requirement for fixing and developing chemicals to be used on a regular basis;
- the storage space requirements for unused film and processing chemicals are very much reduced unless the diagnostic imaging department is printing the majority of CR images acquired;
- the requirement for a darkroom may be eliminated or reduced depending on the extent to which conventional film processing is retained;
- allows the department to make or anticipate the transition to a filmless diagnostic imaging department.

Disadvantages of CR compared with conventional film techniques

3.94 The disadvantages are:

- high initial capital costs when compared to automatic film processing and greater ongoing costs in the case where hard copy films are generated. Capital and ongoing costs may only be offset if the healthcare provider has installed PACS or other types of network for soft copy reporting and review, and has completely moved away from film except for back-up purposes;
- the image quality is not quite as good as that obtained using conventional film/screen media

particularly in chest X-ray and orthopaedic examinations, where there is a requirement for highly detailed images. However, a number of studies undertaken show that this has little impact on the diagnosis from the X-ray films acquired;

- individual units have a lower throughput when compared to modern integrated automatic film processors;
- increased noise during the processing of the films;
- the size of the CR processing and film viewing area in comparison with automatic daylight film areas may need to be increased to accommodate possibly larger CR plate processors (depending on model). There may also be a need for an increased number of multiple units in order to give security against breakdown and match the throughput of the daylight film processing system replaced. In addition, deep worktop space will need to be provided for viewing and manipulation workstations associated with the CR plate readers. This is in comparison with wall mounted X-ray viewers used with conventional processing and these will still need to be provided following the implementation of CR, although usually in smaller number, unless the CR images are printed.

3.95 Where healthcare providers are moving to a CR based system from a film-based practice, it may be that both technologies will be used in tandem for a changeover period. An interim or temporary space requirement will need to be assessed for the CR system(s) whilst they are tested, checked for clinical imaging performance and on-site training is provided to the operators or radiographers. In some instances, CR may be slowly integrated into clinical use and plain radiographic images may be acquired simultaneously using both CR and automatic film processors.

3.96 Dental radiographic images can be acquired using CR technology for virtually all types of film size. Separate units may need to be provided in the processing area to support this aim.

IMAGE ACQUISITION – DIRECT RADIOGRAPHY (DR) – FULLY DIGITAL APPROACH

3.97 With direct radiography, the detector and electronics necessary to convert the X-rays into an image are incorporated within the actual patient table or vertical chest stand. All manufacturers provide an integrated X-ray unit and detector system for acquiring for the images, together with sophisticated electronics for processing the images. Following X-ray exposure, images are acquired and displayed on a computer monitor within 10 to 20 seconds. The operator does not have to process any plates or cassette to form the resultant image. This offers potential advantages over other image acquisition approaches in simplifying staff

workflow, improving efficiency and increasing patient throughput. Following image acquisition, the radiographer will then have the option to print the image using a laser printer or send it to a digital archive. This is similar to the process for CR described above.

3.98 The main disadvantage of DR, at this time, is that operators are constrained to use the DR equipment with patients who are capable of being moved to the appropriate position for the examination. The detector cannot be removed and this makes it impossible to undertake examinations outside of the X-ray room or where the patient is cannot be moved for the examination. The DR system will then need to be supplemented by more flexible CR or conventional processing equipment, in order that non-DR X-ray examinations can be undertaken for patients in A&E, ward areas or ITUs, for example.

3.99 Since the DR equipment incorporates image processing and acquisition within the actual X-ray room, the only separate processing area required will be in support of CR or conventional technologies used to supplement the DR equipment. Space should also be allocated for a laser printer, allowing the radiographers the option to print the images.

3.100 Because this area is undergoing constant technological development, there are currently fewer than five hospitals in the UK that have procured this new type of medical X-ray detection technology. It is expected that the provision of this equipment in the UK will increase and this guidance will be updated to reflect changes in practice. An example of DR equipment is shown in Figure 3.8.

STORING, HANDLING AND DISTRIBUTING IMAGES – CONVENTIONAL AND PART-DIGITAL

3.101 For a department still making use of substantial amounts of film images either acquired using conventional X-ray or printed laser film, these activities have significant space planning implications both in terms of room areas and room relationships, and form a significant proportion of administrative activities and workload.

Film sorting and collating; dispatch and return

3.102 These four activities should take place in single large open plan area. Ideally, it should be adjacent, have good access to, but be separate from the film archive and the main reception area for the department and conveniently located to the processing/viewing and reporting spaces.

3.103 Project teams should pay particular attention to the design of the area used for the sorting and collating of X-ray films. If this area is not well designed it can have serious consequences for the throughput of the

radiology department, and hence the patient throughput of the hospital as a whole.

3.104 Previous records and films will be taken from the film archive and held in readiness for out-patient appointments and for new interventional/diagnostic imaging investigations.

Sorting and collating

3.105 Sorting and collating will comprise the following activities.

- a. ensuring that when current and previous X-ray films are received from the viewing/checking areas, the necessary documentation is attached before being passed on for reporting;
- b. collation and temporary holding of films and documentation in cases where previous records were not initially available;
- c. sorting unreported films on return from the clinician or ward and their collation with relevant previous films and documents ready for reporting;
- d. retrospective collation of current and previous films and documents that were the subject of a “preliminary” report, to enable the initial findings to be confirmed;
- e. administrative arrangements to ensure that the absence limit (usually one to three days) for unreported films are not exceeded;
- f. sorting films for reporting into priorities or categories, for example in-patient, out-patient, accident or those for reporting on by a specific radiologist;
- g. holding films for viewing by visiting clinicians;



Figure 3.8 Example of a Direct Radiography Unit. Image reproduced by courtesy of Kodak Health Imaging

- h. administrative arrangements for monitoring the dispatch and return of films to radiologists for reporting purposes, to ensure that the time limit, usually between a few hours and three days, is not exceeded;
- j. handling requests for specific films and data from clinicians with respect to older films and reports;
- k. assisting clinicians and other members of staff in obtaining radiographic films from previous examinations;
- m. films acquired within the last one to two weeks will tend to be heavily accessed by clinicians, so limited film storage may be appropriate, in order that films can be stored in this area before being placed in the two-year or long-term film archive;
- n. a number of workspaces (bench space) should be provided for the sorting and collating of films in this area. As an indication only, one such workspace should be allocated for each diagnostic imaging modality in full use that produces film as the end result. This is based on a busy DGH producing 100,000 examinations per year. This will need to be substantially increased for larger diagnostic departments producing greater quantities of film. Clinicians and potentially researchers will probably wish to gain access and work in this area and as such ample benching should be provided to allow for one or two "hot" workspaces.

3.106 Each workspace will require a computer terminal linked to the RIS/HIS system. X-ray film viewers will be required at a ratio of one twin unit per workspace. Space should be provided for a photocopier and trolleys used for document movement. Suitable racking will be needed for the sorting and short-term storage of films and records.

3.107 Since sorting and collating staff will spend most of their working day in this area, provision should be made for comfortable working conditions and priority should be given to providing natural ventilation and daylight.

3.108 For departments that require a digital record of the X-ray film, it may be appropriate, for reasons of workflow, staffing and film access, to locate a digitiser in this area or directly adjacent to it. This may be required for teleradiology and/or departments making the transition from X-ray film to digital technologies. The digital archive to support this activity may be housed in a machine room elsewhere in the hospital or department, as described below. Where such a digitiser is located, measures should be undertaken to minimise the amount of dust and control the ambient temperature, as these factors will affect the function

and reliability of the unit. The provision of air conditioning in this area may be particularly appropriate.

3.109 The size of digitisers varies between manufacturers and will also relate to clinical function, as high resolution digitising is required for mammography films. Smaller models may be worktop mounted, with an associated computer workstation. Larger models may be free standing and also require an associated computer workstation. In addition, bench space should be provided around the digitiser to allow for the sorting of films during digitisation.

Dispatch and return of films

3.110 This activity should be carried out adjacent to and as an integral part of the sorting and collating activities described above. Additional reception counter style space should be allocated for the dispatch and return of films and reports and for queries concerning their location. Storage racks will be required for the preparation of films and reports for dispatch.

3.111 If immediate reporting is not available, and the clinician wishes to see the films before the patient leaves the hospital or before deciding on treatment, the unreported films are dispatched to that clinician, usually in a suitably distinctive "unreported films" envelope. Where possible, previous films will be included for comparison. The patient's original envelope and documentation will be taken to the sorting area to await the return of the unreported films. A separate computer terminal may be provided in order to help staff keep track of dispersed records and films. This may be integrated with the RIS and HIS.

3.112 If the department sub-divides the film archive so that older films are stored remotely from the department, then this area may also be used to collate and dispatch films to the remote archive.

3.113 As a guide, two people will be working in this area on a full-time basis, particularly if films are transferred to another site after the two-year limit has expired. This is based on the assumption that a department is producing 100,000 X-ray films per annum.

Film archives

3.114 Generally, the written radiological report constitutes a legal document and must be retained for a minimum of eight years. This should be undertaken digitally using a small computer server or small archive. Additionally, printed copies of the reports may be added to the film packet where appropriate. Physical access to the computer server should be carefully controlled to authorised members of staff and this unit should be stored in a locked room. The provision of a back-up server duplicating all the data on the main unit in a

separate building should be considered as a means of ensuring a data back up and protection against fire. It should be possible to access this archive through an RIS network. The accompanying X-ray film should be stored in an accessible film archive, typically for seven years, but according to local hospital policy. Film archives may be divided depending on the age of the diagnostic images and type of image acquired.

3.115 There will be special requirements for longer-term retention of images acquired of paediatric patients, where the films should be retained until they reach 18 years old or the films become 7 years old, whichever is longer. For those patients with disabilities and where research is undertaken at the institution, the films should be retained for at least 50 years or until the clinician no longer believes that the images make a relevant contribution to the patient's care. Tertiary referral centres and teaching hospitals may have a requirement to keep X-ray films longer than 50 years for research and teaching purposes.

3.116 As stated above, the film archive may be provided into two distinct areas. Film storage may be provided for films for up to two years in the main department, since research has demonstrated that clinicians and radiologists working in the hospital frequently access them. Films greater than two years old are less likely to be accessed frequently, so it may be more economical to store them away from the department, either elsewhere in the hospital or at another location.

3.117 Films may be stored on fixed racking or, alternatively, on various proprietary systems, such as carousels or floor tracked mobile shelves, which can be moved to gain access to particular files or films where space is limited. The X-ray film when stored will have a significant weight implication and this should be taken into account in the construction of the shelves. Space should be available between the shelves to move a trolley through these areas. The shelves should be stacked as high as is possible for safe use of "kick stools" to access the films.

3.118 Storage for any other recording media (for example videotapes and optical disks) should also be provided. This may be in addition to the film storage requirements if the department is taking part digital and part conventional approach to the processing of images. The requirement here will depend on the arrangements at the modality for the provision of CD-ROMs and videotapes. Common practice, as currently observed, is to keep the CD-ROMs in the control room related to the modality. Project teams should review this policy early in the planning stages and consider use of "fireproof" safes.

3.119 Wherever records are stored, steps must be taken to maintain confidentiality and security of the data

by the use of key-coded door mechanisms to gain entrance to the film archive(s).

3.120 The film library may house the only record of the radiological investigations undertaken in a department, so a number of measures should be undertaken to minimise the possibility of fire in this area.

3.121 The film archive or the two-year film archive should be adjacent and directly accessed from the sorting and collating areas within a department.

3.122 Depending on size and layout of the film archive area, the provision of a small extent of worktop space and of a two- or three-panel film viewer should be considered, to allow clinicians and other clerical staff to review and check films before leaving the area.

3.123 Film archives should be carefully planned in terms of layout and circulation. The stored X-ray films and records will generate and collect dust and consideration should therefore be given to minimising dust accumulation by means mechanical ventilation. Lighting should be a high standard with light fittings laid out in relation to the racking and if possible natural light should be introduced, possibly by high level windows.

STORING, HANDLING AND DISTRIBUTING IMAGES – FULLY DIGITAL APPROACH

Sorting, collating, film dispatch and return, film archiving

3.124 With fully digital image acquisition and archiving, there is no longer a requirement for large spaces to be allocated to the activities of sorting, collating, dispatch/return and film archiving. The extent to which this can be achieved will depend on the modalities used. However, even in fully digitally based diagnostic imaging departments with integrated hospital networks, there will be a residual requirement for the provision of a small sorting collating area and film archive for hard copy film in the following instances:

- images that have been generated elsewhere, possibly at another hospital which does not have teleradiology facilities;
- hard-copy films generated by mammography studies;
- hard-copy film produced at the request of other hospitals or clinicians;
- hard-copy film produced during downtime of the PACS or when the system is undergoing a major upgrade;
- the storage of film acquired before the introduction of PACS and digital imaging;

- hard-copy films generated during the transition period between PACS and conventional imaging.

3.125 When a transition is planned from film use to partly or largely digital use then a proportionate extent of the area formerly used for sorting and collating, and film archiving will probably become available for other uses.

3.126 Local digital archive storage may be provided for individual or multiple digitally based modalities, such as CT and MRI. This may take the form of a small CD-ROM archive or a small jukebox, for example, which may be able to hold images from these modalities for up to seven years. This may be located in a control area or reporting area attached to a combined CT/MRI computer workstation, or, preferably, within a separate environmentally controlled machine room. Please note that 24-hour access to the archive for clinical images will be required. This may be used as a precursor to or used in conjunction with PACS and is sometimes referred to as “mini-PACS”.

3.127 A full machine room for a hospital wide PACS system, which will provide space for the installation of the CD-ROM archive and server, should provide the digital equivalent of a film archive or magneto based optical archives, computer racks and server units. This machine room will require air conditioning to maintain environmental conditions within certain tolerance values, to minimise any downtime from overheating. Space around the archives or jukeboxes should be left for maintenance and upgrading.

3.128 A supporting office adjacent to the digital archive or machine room may be required for systems support engineers. Space for tools and some spare parts should also be provided here.

3.129 As a general indication, the total area of the machine room, and supporting and residual areas will be approximately one-quarter of the total area of a conventional film archive combined with sorting and collating areas.

3.130 Further information is contained in the PACS supplement (forthcoming).

IMAGE REPORTING

3.131 Diagnostic image reporting can be undertaken either in shared reporting areas or within radiologists’ offices, or, where more complicated imaging or interventional procedures are used, within the control areas.

3.132 Reporting facilities, individual or shared, should be grouped together with easy access to the secretarial facilities and, in larger departments, to the central seminar room.

3.133 There should be an early decision on the extent of shared reporting areas, as the approach preferred will have an impact on the space requirements for the department. In a department that employs both consultant and non-consultant radiologists and where some films are reported by senior radiographers, a mixture of personal offices equipped for reporting images and shared reporting spaces should be provided.

3.134 Shared facilities have the advantage that they allow clinicians to easily share results and, where appropriate, discuss difficult cases, thereby permitting improvements in clinical understanding and continued professional development. Some cost savings through space and equipment efficiencies may be achieved, as clinical reporting stations can be provided for more than one radiologist. Expensive and one-off pieces of image viewing equipment such as a Smartlight™ viewer or specialist computer workstation would also be accommodated in a shared reporting area. This equipment has particular space requirements, as described below. The main disadvantage is the loss of privacy and the potential for continuous interruptions from noise and other members of staff. Even when shared reporting spaces are included in the design, general office space should also be included, to allow clinicians to undertake general administrative duties such as auditing and education.

3.135 Image reporting areas and radiologists’ offices should be adjacent to the main department. This is made easier if the hospital has installed a PACS system or has some networking capability between the reporting areas and some of the modalities.

3.136 The type of reporting will significantly affect the nature of reporting spaces. For hard-copy reporting, film images are viewed on a series/bank of X-ray viewers (light-box). Soft copy reporting requires digital images to be viewed on single or multi-viewing monitor computer workstations. A combination may be needed because of the presence of both digital and analogue modalities, or because of a transition phase towards a full PACS environment.

3.137 Spaces required for current soft copy reporting workstations are significantly greater than those required for hard-copy reporting. Principally, this is due to the depth of worktop space required.

Radiologists’ offices

3.138 There should be an office for each full-time consultant and/or whole-time equivalent consultant. There will need to be storage space for the audit and confidential records, and a limited space for books, periodicals and images of special interest. Consultant radiologists’ offices will be used for viewing and



Figure 3.9 Example of a quadruple monitor soft-copy reporting computer workstation.

Image supplied by Royal London Hospital

reporting, for consultation with colleagues and others, for audit, management and general administrative work. It is unlikely that patients will consult directly with radiologists in these rooms.

3.139 If the reporting is undertaken from hard copy films, then at least six viewing boxes in a three wide by two deep arrangement and good sized worktop space (at least 800 mm deep) should be provided. Workspace should be provided for a PC workstation, which may be interfaced with the RIS and must at least allow access to the typed reports for checking and other administrative duties. A low speed data access point should be provided within the room to facilitate this activity. The dictation of reports may be undertaken using an integrated department wide, digital dictation system or, alternatively, using small hand-held dictaphones. See also the notes below on secretarial support activities regarding the introduction of voice recognition technologies.

3.140 Where reporting is undertaken in this area, and one or more of the imaging modalities generate images digitally, it may be impractical to print the images acquired. If so, space should be provided for an imaging workstation to review and report the images. These workstations may have up to four 54 cm CRT monitors stacked in a two by two arrangement to allow the display of multiple sets of data. A high-speed data access point for image transmission should be provided, which may also access the RIS system.

3.141 Please see below on environmental requirements for reporting.

Shared imaging reporting areas

Hard-copy film reporting suitable for all modalities

3.142 These rooms should be equipped with continuous worktops, which should be deep enough to accommodate a PC workstation for access to an RIS, and which will also provide general film layout and

writing areas. A typical depth of this worktop will be 600–800 mm. The worktop may be sub-divided to provide individual workstations, using sound absorbent screens. Each workstation area should be at least 1800 mm wide to accommodate up to four wall-mounted X-ray single viewers side by side.

3.143 The worktop design should allow for easy cable management and should have cantilevered under-bench supports to allow for easy movement by staff along the worktop. Each workstation should be provided digital dictation, phone and data access points as appropriate to local policy and networking development plans.

3.144 A Smartlight™ system may be provided in one or more workstation areas, in which case a deeper worktop depth of at least 850 mm, preferably 1000 mm, will be required. A Smartlight™ system is an advanced film unit designed to enhance film viewing and reporting by allowing low glare viewing of selected portions of the hard copy film, together with other features, such as contrast enhancement, that are normally associated with soft copy reporting. The units are installed on a worktop and an indicative footprint for a typical model would be 700 x 350 mm (W x D). It would stand at least 700 mm high above the worktop. A separate bracketed wall mounted optical device forms part of the Smartlight™ system.

3.145 Similarly, a multi-rotating automatic X-ray film viewer may be appropriate in one or more workstation areas. Alternatively, a single unit maybe provided in a seminar room. These units are floor-standing and in some cases semi-mobile. Units allow between eight and ten X-ray films to be viewed simultaneously in a five wide by two high arrangement. Many more films can be loaded into the viewer before the commencement of the reporting session and this allows, in theory, for faster film handling times. An indicative overall size of such a unit is 1800 x 2000 x 1000 mm (H x W x D), including a film layout workspace.

3.146 These types of multi-rotating film viewer may be particularly advantageous for reporting large numbers of films acquired in screening, for example mammography or chest X-ray films for tuberculosis. For reporting screening examinations in a shared reporting area, it is important to achieve good acoustic separation between the individual workstations.

3.147 In planning the layout of a hard copy reporting area, flexibility should be built in to allow for greater worktop space requirements for possible future soft-copy reporting.

3.148 Please also refer to the section below on environmental requirements for reporting.

Soft-copy film reporting suitable for all modalities

3.149 A worktop space at least 500 mm deep, for a keyboard and mouse, plus a console space accommodating four-image review in a stacked 2 x 2 arrangement, should be provided. This console space will require an additional depth, depending on the depth of monitor used and cable space needed, giving an overall depth of approximately 1250 mm. This depth requirement may reduce considerably with the gradual introduction of TFT flat screen technology. Such a workstation will be at least 1000 mm wide for a 2 x 2 arrangement, but will increase if more monitors are required. Additional workspace may have to be provided for an RIS terminal if the functions of this database cannot be integrated with those of the digital reporting computer workstation. A high-speed data access point should be provided to allow fast transfer of the images to the digital viewing units.

3.150 Particularly in transitional periods between hard copy and soft-copy film reporting, continued provision should be made in this area for a limited amount of hard-copy film reporting.

3.151 Reporting for digital mammography films usually requires high-resolution monitors, which may need to be of higher specification than those used to report other images from other modalities. A separate workstation may have to be created to facilitate this requirement, it may contain a greater number of monitors stacked singularly in a horizontal plane, necessitating a greater width for the workstation.

Environmental requirements for reporting

3.152 Construction of the reporting stations and radiologists' offices should be designed to achieve speech privacy.

3.153 A number of studies have shown that ambient light conditions can have an affect on the accuracy of reporting diagnostic images acquired either by hard or soft-copy reporting. Light generated from artificial sources should be easily controlled by the use of dimmer switches below 2 lux. If the room contains a window, blackout blind provision should be considered. Task-focused lighting should be provided to assist the radiologists in some of their activities. These environmental conditions are particularly important when undertaking the reporting of mammography films.

3.154 As a minimum, the rooms should be mechanically ventilated, but where possible, air conditioning should be provided to allow for comfortable working conditions.

SECRETARIAL SPACE AND ROOMS

3.155 Current practice in the UK is for radiologists to dictate the reports using either a handheld dictaphone

or a departmental digital dictation system. The reports are transcribed by PAs to the radiologists working in the department and then saved to an RIS system or small PC server connecting a number of terminals within the secretarial office. An office area, usually within a shared space, will be required for each PA in the performance of his/her duties, which include supporting the radiologists in configuring appointments and meetings. As a guide, at least one secretary will be employed per consultant radiologist, with one additional member of the secretarial team supporting two or more registrars.

3.156 If a digital dictation system has been installed together with recording facilities, this may permit flexible working practices such as "hot-desking" and remote or home based working with the provision of appropriate technology.

3.157 The office space for the secretaries should be provided close to the radiologists' offices and the shared reporting area, as they will probably wish to seek clarification of clinical terms and other aspects of the reports dictated by the radiologists.

3.158 Commercially available voice recognition systems and software are currently in development, but the technology has not yet sufficiently developed or has become accepted for this application. In the short term, a number of commercial systems are available that enable the radiologist to simply construct a standard report. This may change over the next five years and may reduce the need for secretaries to type dictated reports. This may see the future role of radiology secretaries change considerably.

MULTIDISCIPLINARY CLINICAL CASE CONFERENCE ROOMS

3.159 It is essential that accommodation for multidisciplinary radiological conferences should be provided in association with the diagnostic imaging department. For smaller hospitals, it is anticipated that this accommodation will be shared with other clinical departments such as orthopaedics and therefore may be sited outside but adjacent to the diagnostic imaging department. In larger and medium sized departments and those with a high frequency of consultation (for example neuro-radiology), this will be sited within the diagnostic imaging department. Access to the RIS should be provided in either variant of seminar room outlined below.

Conventional film based departments supporting some digital modalities

3.160 Facilities should be provided for simultaneously viewing a large number of multiple sizes of X-ray film and other digital images. This may be achieved using the following equipment.

- a. a multi-rotating automatic X-ray film viewer, as described for reporting areas, may be provided;
- b. a bank of wall mounted or mobile X-ray film viewers allowing for a minimum of eight films to be displayed. The mobile viewer will include an integral lay-up shelf and will typically be sized 1750 x 1600 x 500 mm (H x W x D);
- c. a computer workstation for displaying images acquired at digital modalities and stored to CD-ROM. It should be equipped with two dedicated monitors;
- d. a Smartlight™ X-ray viewer.

3.161 Provision should be made, in the form of trolleys and ceiling or wall mounted projection screens, for projecting slides, OHPs and lap-top based presentations. A television monitor may also be required to view videotapes of clinical images stored to this medium and for displaying still images acquired from an in-room column mounted television camera. This monitor may be mounted on a trolley, worktop or wall bracket. Storage will also be needed for associated VCRs.

3.162 Additional equipment may include:

- a white/marker board;
- general storage provision, possibly including magazine racks;
- a small amount of worktop or table space together with suitable wall mounted power, phone and data outlets.

3.163 The lighting in the room should be dimmable to the low lighting conditions required for reporting. Blackout blinds should be fitted to any windows. As a minimum, mechanical supply and extract ventilation, but preferably air-conditioning, should be provided.

3.164 In most situations the room should be sized to allow for comfortable seating for at least 15 to 20 people.

Digitally based departments

3.165 The room should be equipped with a fixed ceiling or floor mounted digital projector and large projection screen for the display of multiple digital diagnostic images. As an indication, the projection screen should be approximately 2000 x 3000 mm (H x W). The selection of projected images will be controlled at a computer workstation, which may comprise up to four large diagnostic image display monitors with associated devices. This workstation should be located on a mobile trolley and, where small numbers of clinicians are involved, the conference may take place at the workstation itself. A high-speed data link must be provided for use with this workstation. Where it is possible to simultaneously view the digital images at two or more discrete locations within or beyond the hospital then the provision of data, video and phone conferencing facilities may be appropriate.

3.166 A small amount of provision for film viewing boxes should also be provided, again on mobile trolley, to review older hard-copy images. These will almost certainly be required in transition phase from film to digital imaging. Provision should be made to maintain security within this room. In all other respects the design of the room should be as described for hard-copy film conferencing, with the exception of the provision of expensive hard-copy film viewing devices and the provision of many X-ray film viewing boxes.

Summary

3.167 The three different approaches, conventional, part digital and fully digital, have been summarised in flowcharts (Figures 3.10–3.12).

FIGURE 3.10

Flowchart of workflow and image management sequence for film/conventional based procedures

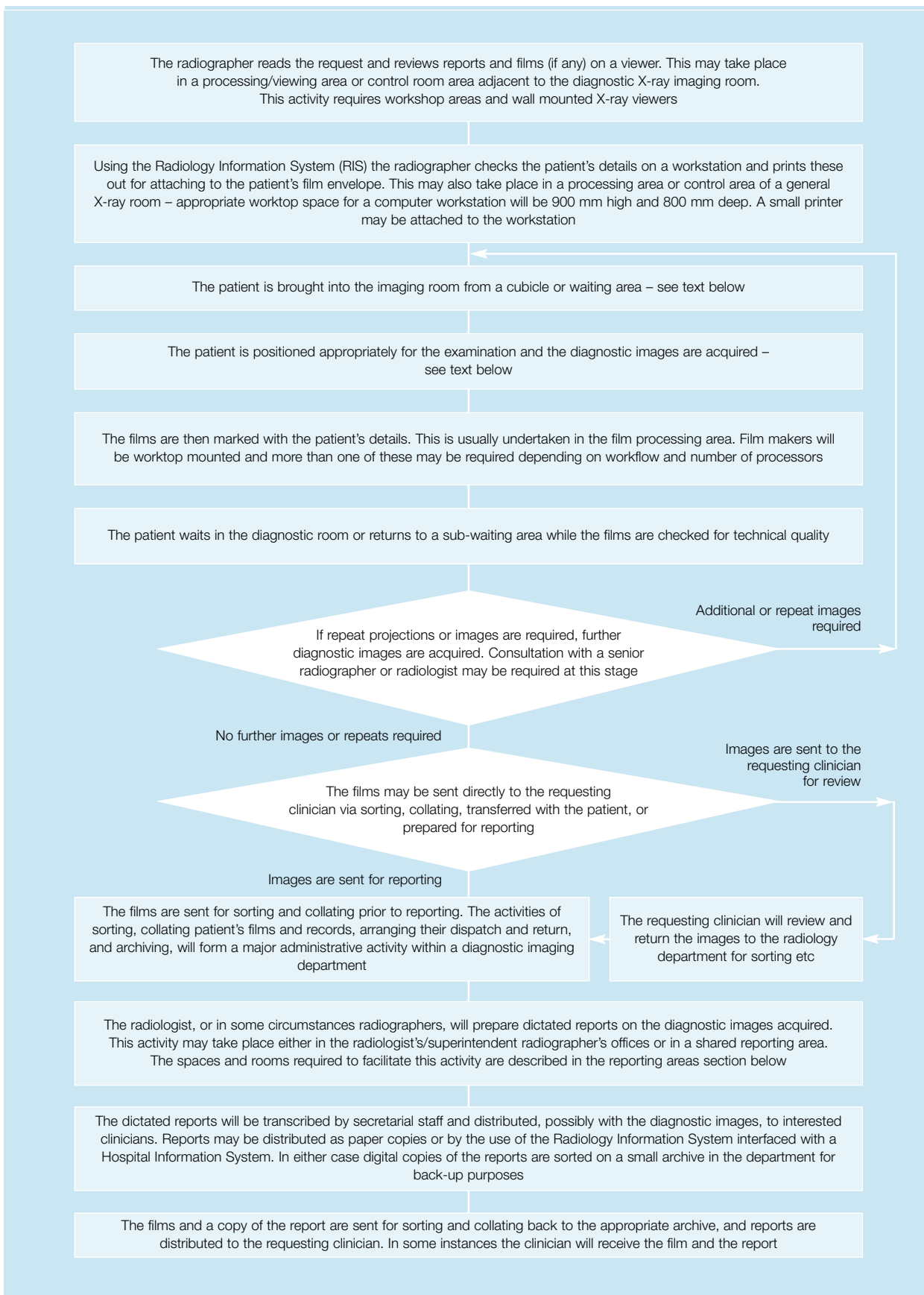

FIGURE 3.11

Flowchart of workflow and image management sequence for soft-copy laser printing



FIGURE 3.12

Flowchart of workflow and image management sequence for soft-copy image distribution and reporting

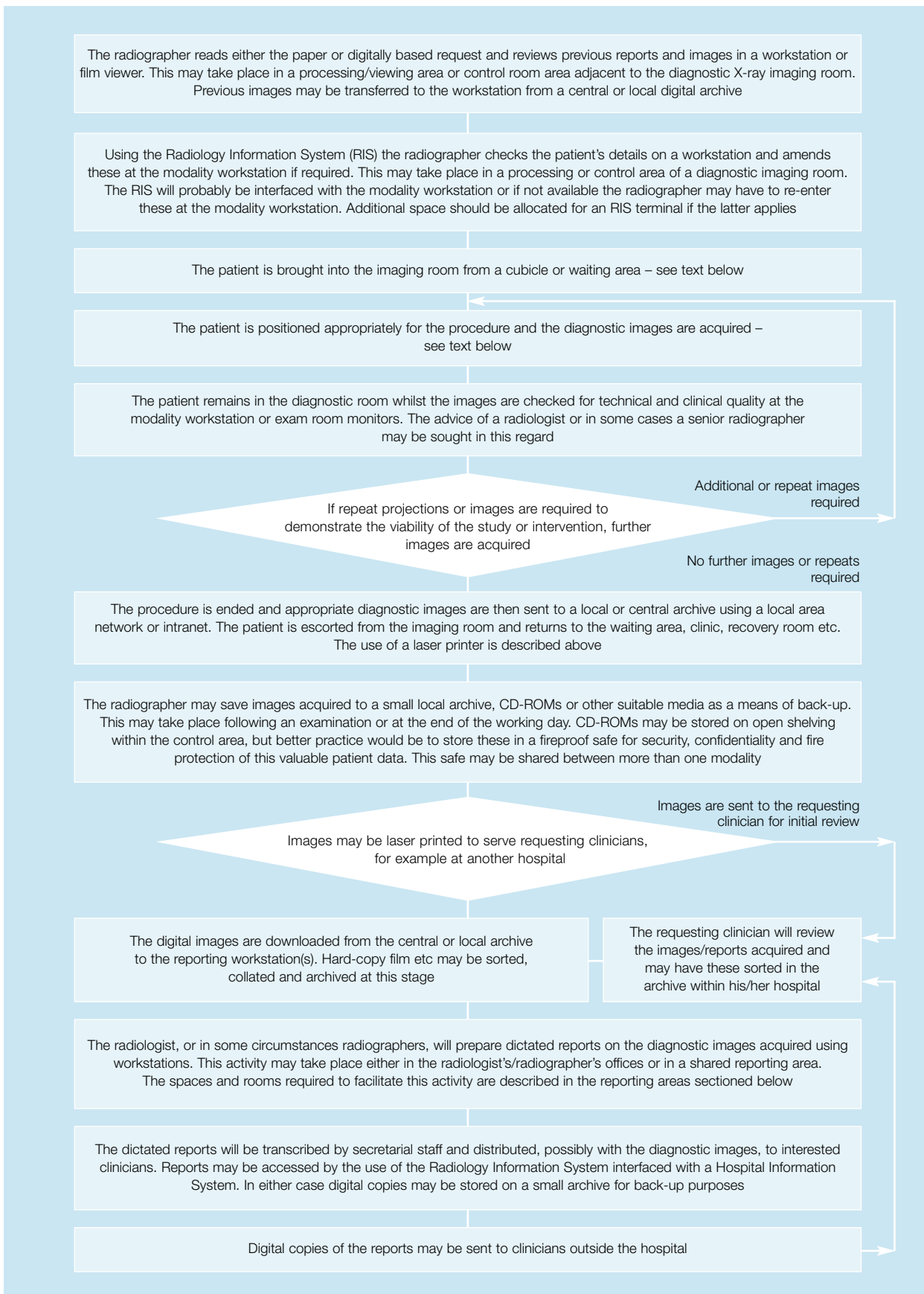

4 General X-ray imaging or radiography

INTRODUCTION

4.1 This chapter describes the equipment and accommodation required to facilitate general X-ray diagnostic imaging (general radiography) procedures. It includes descriptions of the diagnostic rooms, supporting spaces and associated aspects of design and construction. The descriptions are further supplemented by the text in [Engineering Requirements, Appendix 2](#).

4.2 Other sections of this document describe imaging procedures and design of rooms for specialised X-ray diagnostic imaging procedures, such as fluoroscopy, angiography and interventional radiology.

4.3 The use of general X-ray as an imaging modality has been replaced in some radiography facilities by ultrasound, MRI and CT.

CLINICAL AND OPERATIONAL OBJECTIVES

Cancer imaging

4.4 X-ray imaging is useful in initial investigations for diagnosing benign and malignant tumours. Although the test may not be specific or sensitive, an X-ray examination may be used to exclude some types of pathologies, or provide suitable evidence for clinicians to request further investigations with other modalities, in particular CT, MRI or radionuclide imaging.

4.5 Since X-ray imaging can be used for the planning, staging, monitoring and follow-up after and during radiotherapy and chemotherapy treatments, a general X-ray unit may be installed in, or close to, a cancer centre or unit to facilitate these objectives.

4.6 Patients attending a cancer out-patient clinic may be referred for an X-ray investigation and asked to return to the clinic with the X-ray films. Alternatively, the X-ray department may have arrangements in place to facilitate this transfer.

4.7 CR facilities, described in Imaging Approach, [Chapter 3](#) of this guidance, may speed up this process, as images can be distributed over local and wide area networks.

Chest imaging

4.8 Under the NHS plan, it is proposed to set up a number of chest pain clinics. Diagnostic imaging, including chest X-ray examinations, will be required as one of the first line examinations to support such clinics. Therefore it may be appropriate to install general X-ray units close to or as part of these clinics. Further description of these facilities is made under NHS Estates guidance 'Facilities for cardiac services'.

4.9 Chest X-rays may make up a large percentage of the total X-ray examinations undertaken within a diagnostic imaging department. The majority of general X-ray rooms should be fitted with facilities to permit these examinations to be undertaken for paediatrics and adults. The chest X-ray may be used to investigate the following pathologies:

Tuberculosis (TB) and dedicated chest units

4.10 The incidence of TB is increasing, particularly in some of the larger cities within the UK. TB is also a likely opportunistic infection with patients suffering from HIV or AIDS. The chest X-ray or radiograph still remains as the mainstay of diagnostic investigations in this area.

4.11 Specialist digital chest units may be appropriate in this application for reasons of speed, accuracy, data retention and access to patient data in screening applications. Some tertiary or large secondary care hospitals may consider it necessary to install these dedicated units and the built environment implications of these units will be described in Part 2 of this guidance in the future.

Cardiopulmonary disease and trauma

4.12 The chest X-ray can be used as one of the first line diagnostic investigations into the presence of congestive heart disease or the presence of an enlarged heart and into pulmonary conditions arising from infection or injury.

4.13 For in-patients, examinations may be undertaken in coronary care units using mobile X-ray systems. This is further described in the mobile radiography section in [chapter 14](#).

Pulmonary embolism

4.14 A chest X-ray is usually undertaken before a radionuclide ventilation and perfusion scan for suspected pulmonary embolism. The diagnosis is usually made using the results from the radionuclide investigation or CT combined with the chest X-ray.

Fracture and orthopaedic clinics

4.15 Patients who are attending fracture and orthopaedic clinics may be referred for an X-ray examination during the clinic. As these clinics tend to be relatively busy, the turnaround time should be fast and patients may be asked to return to the clinic with the films or have these sent directly to the clinician during the clinic. The purpose of the X-ray investigations may be to monitor bone repair following a fracture or to monitor the success of a hip replacement operation.

4.16 Alternatively, for images acquired using CR there are many advantages in sending images to the clinicians at the time of the clinics using a local area network. This may include the use of a large digital archive or images may be printed within the department and maintained as a permanent medical record and used for reporting purposes.

4.17 There should be a relatively close building relationship between the orthopaedic/fracture clinics and the general X-ray facilities used to support the clinics. Some options in this regard are described later in this section under Trauma Imaging X-ray.

Joint radiographs in preparation for surgery

4.18 Joint radiographs are used for patients prior to undergoing surgery to replace a hip, knee or possibly a shoulder joint.

Mobile general radiography

4.19 Where patients may be unable to be moved from the ward or another clinical unit, then the radiograph may have to be taken in situ using a mobile X-ray unit. Aspects of radiation protection in relation to ward use of mobile X-ray equipment and design of facilities for the storage and maintenance of mobile equipment are described in the mobile radiography section.

4.20 The images acquired may be processed either in the main processing area of the Diagnostic Imaging department, or (if supported within a business plan) by the use of film processing or – as is becoming more common CR facilities – at or near the clinical unit. In some cases the processing facilities may be shared between an ITU, CCU and a high-dependency unit.

4.21 For discussion of mobile image intensifiers please refer to [Chapter 6](#) on fluoroscopy.

General support for A&E

4.22 General X-ray equipment is used heavily in support of Accident & Emergency, often in diagnosis of suspected fractures or other forms of trauma. Further details are provided in the Trauma Imaging section [paragraphs 4.80 to 4.97](#).

4.23 As such the relationship between X-ray facilities and A&E needs to be considered and the options for this provision are further described below.

PATIENT JOURNEY

4.24 Please also refer chapter on diagnostic image handling and processing in the Imaging Approach section above, which describes patient journey aspects during processing and checking. Please also refer to the supplement on PACS (forthcoming).

Referral

4.25 Patients may be referred for a general X-ray examination as out-patients by a GP, whilst attending an out-patient's clinic, as an in-patient transferred from the ward areas of the hospital, or directly from the A&E department. In the majority of cases, a request form will accompany each patient referred. Out-patients will usually be attending by appointment, either directly at the diagnostic imaging department, or from another out-patient speciality clinic requiring diagnostic imaging support. A member of administrative support staff will enter the details from the request form into the Radiology Information System, or for referrals made out of core hours, the radiographers will undertake this task at the time of or during the examination.

Examination attendance

4.26 Patients may attend for their examination either on foot, in a wheelchair, or in a trolley or bed. The doorway entrance used for patients must allow access for King's Fund beds with accessories such as drip stands and other monitoring equipment.

4.27 Out-patients will report their presence at the main reception area and will be asked to wait in a local sub or main waiting area, prior to examination. At reception, the patient's inclusion on current diagnostic imaging work lists will be checked and confirmed. These work-lists are typically managed using a computer-based Radiological Information System (RIS) which is linked to the individual X-ray rooms. The request form will be taken to the processing area either by the radiographic or the administrative staff. This makes the radiographer's aware that patients are attending for their examination. Out-patients would either return home and make an appointment with their GP, or return to the out-patient clinic they were attending.

4.28 In-patients, who may have received sedation, will be referred from ward areas and, in some instances, given a higher priority than out-patients. The request form will be sent directly to the diagnostic imaging department and the examination will be pre-booked and co-ordinated with (if necessary) the portering staff. If possible, separate access routes and waiting areas should be provided for in-patients, who may be unwell and transferred on trolleys or beds. In-patients will still need to check in at main reception although accompanying staff may assist in this process. Once the examination has been completed the patients return to the wards.

4.29 Patients attending from an adjacent A&E department may be non-urgent. Non-urgent ambulant cases may bring their own request forms from A&E to the diagnostic imaging department reception area and will remain in the main or sub waiting areas, as also used by out-patients, until they are examined. Urgent cases are likely to be transferred by trolley and will be examined as soon as possible. Such patients may be accompanied by nurses, porters and in some instances doctor or other clinicians. Once the examination is completed, patients may return to A&E or be sent directly to a general ward or, where appropriate, to CCU or an HDU. General X-ray rooms used for A&E procedures should be made slightly larger to allow for good manoeuvrability of beds and trolleys.

4.30 According to the nature of the X-ray examination and the body part being examined, patients may need to partially or fully undress, and change into a hospital gown. Alternative planning arrangements for the provision of patient changing and waiting facilities are described in room descriptions below.

4.31 General X-ray procedures are typically of short duration when compared with many other diagnostic imaging procedures. As an indication, the whole procedure may take on average ten minutes per patient.

Special paediatric considerations

4.32 Parents and guardians may accompany paediatric patients, possibly with siblings and other nursing staff or volunteers. Sometimes, the people accompanying the paediatric patient will be present during the examination either within the examination room itself, with appropriate radiation protection or within the control area. Space provided within the control room should allow for this if high numbers of children are to be examined.

LIST OF ACCOMMODATION

4.33 The list of accommodation in support of a general X-facility room should be as follows:

- an examination room containing the X-ray tube, patient table and possibly vertical stand or bucky;
- a control area shielded by the use of fixed lead radiation proof screens. This may take up a portion of the examination room or may be a separate area;
- a processing area to develop the films. In some instances this may not be required and will depend on the technological options chosen;
- sub-waiting areas for both out-patients and where appropriate in-patients;
- changing cubicles for patients;
- toilets for use by the patients and accompanying relatives.

4.34 Other accommodation which may be shared with other modalities in a larger diagnostic imaging department is described elsewhere but listed here for reference purposes:

- a porters' base to assist with the transfer of patients to and from the wards;
- a counselling room;
- a main reception area for patients.

4.35 Where a film processing/viewing area is planned within a facility, then the general X-ray examination room must be directly adjacent. The control area, within the X-ray room should be planned to adjoin the processing and viewing area for radiation protection reasons and staff workflow.

4.36 Patient changing facilities and related sub-waiting areas, where needed must be readily accessible in relation to the examination room.

ROOM AND EQUIPMENT DESCRIPTIONS

The examination area

The X-ray tube

4.37 This may be mounted on a telescopic vertical column, which is ceiling-suspended on mobile tracking, allowing the tube to be moved over a wide range of alternative positions. The X-ray tube may also be rotated in both directions in relation to the vertical column. This configuration is favoured, due to its inherent flexibility, particularly where A&E radiography is undertaken. Further detailed requirements for the installation of ceiling-mounted X-ray tubes are described in [Engineering Requirements, Appendix 2](#).

4.38 Alternatively, the X-ray tube may be mounted on a floor-mounted column, which may be integrated with the patient table and X-ray generator. This allows for a

compact but less flexible X-ray unit. Such a unit may be suitable where space is limited, but is not appropriate for A&E radiography or applications where more flexibility is needed.

4.39 How the configurations affect the design is described below, together with example layouts. Please refer to Figure 4.1 and [Appendix 1](#).

The patient support or table

4.40 For many X-ray examinations, the diagnostic image will be taken with the patient lying on the table and positioned according to the particular body part to be imaged. The table is a substantial item of fixed floor-mounted equipment. The tabletop and film cassette holder move together, independently of the base of the table, are adjustable for height and for horizontal movement in two planes, and require a power supply, necessitating under-floor cabling. The X-ray table also incorporates the Automatic Exposure Control (AEC)

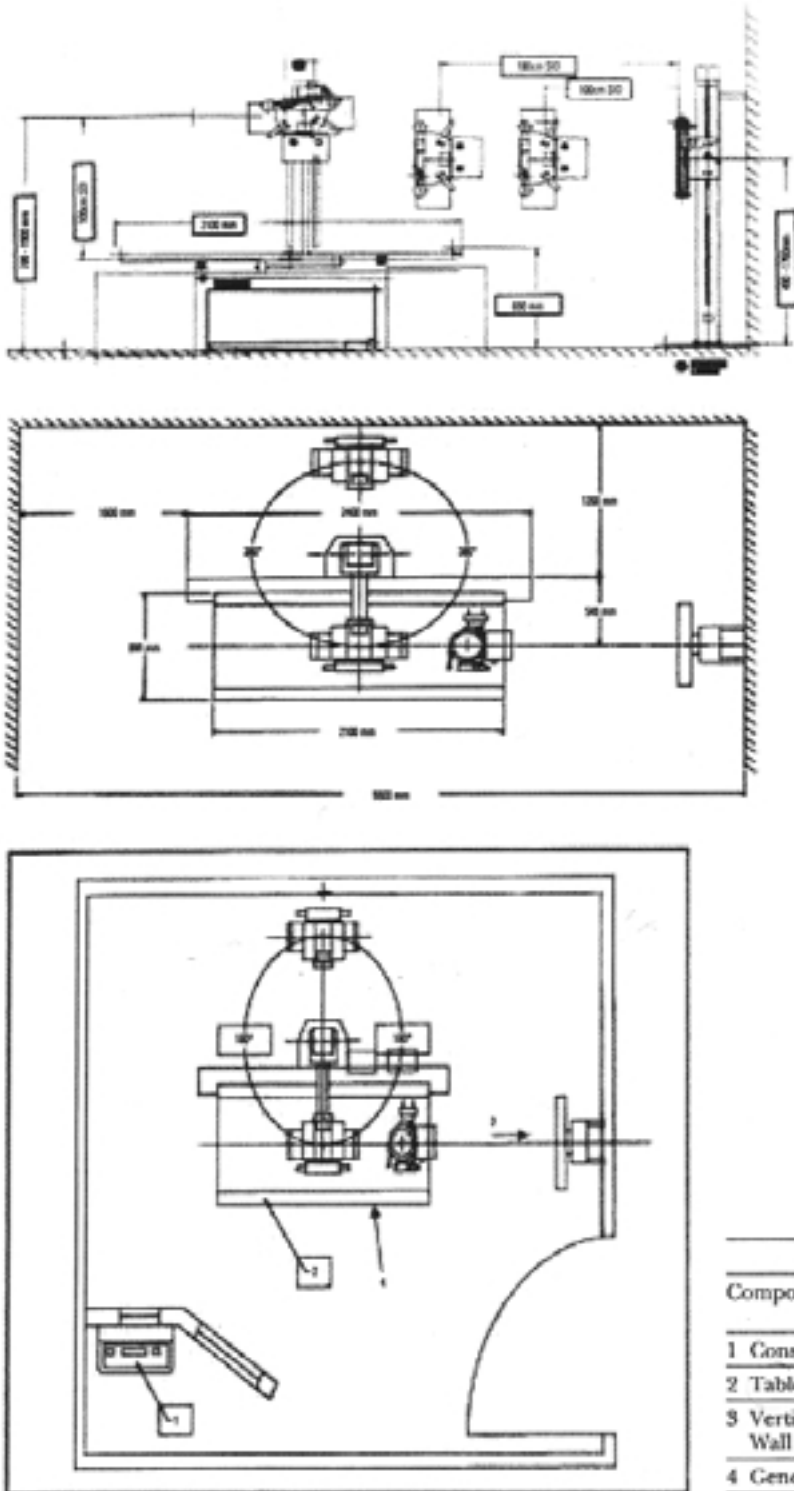

Figure 4.1 Example of floor-mounted general X-ray unit with integrated table and X-ray tube

Typical Room Layout				
Component Specifications				
Component	Length mm	Width mm	Height mm	Weight kg
1 Console	560	310	110	2
2 Table	1174	2400	690	441
3 Vertical Wall Stand	600	600	2000	120
4 Generator	497	400	485	30

devices and a film bucky incorporating an oscillating radiographic grid into which the X-ray film cassette is placed prior to exposure.

4.41 The table will be installed off-centre with respect to one room axis and central to the other, as indicated by the example plans and key diagrams within [Appendix 1](#). This is to facilitate patient access and transfer of patients from trolleys.

A chest stand or chest bucky

4.42 Typically, these devices are used for acquiring chest X-ray films and undertaking lateral exposures with the patient either standing or seated. They are installed in the majority of general X-ray rooms. The chest stand will usually be installed close to the wall of the examination room and comprises a vertical frame or column which can be attached to both the ceiling, floor or wall depending on model and design, together with a cassette holder or bucky. The cassette holders are approximately, at maximum, 800 mm x 750 mm x 200 mm when assembled, and can easily hold a 43 cm x 35 cm radiographic or CR cassette. Some vertical buckies require a power supply for an oscillating grid and AEC devices that are incorporated into the overall design of the system. In some instances, passive vertical chest stands may be utilised and thus do not incorporate these items and do not require electrical power.

4.43 Separate chest stands are available for adults and small children and may need to be installed simultaneously in the same general X-ray room.

4.44 For neonates and small children special devices may need to be stored within the room to permit chest radiography to be undertaken. This will probably only apply in specialist paediatric centres.

4.45 Within a DGH diagnostic imaging department, a single smaller passive chest stand should be installed for paediatric patients into at least one X-ray room. Additional units may be required, depending on patient throughput.

4.46 Some units available are arranged so that the cassette holders or buckies can be rotated through 90° and moved to a horizontal position for the examination of the extremities. Space should be allowed to permit the full range of movement of these devices and for radiographic exposures of patients either standing or seated.

4.47 The same X-ray tube, either floor or ceiling-mounted, is used for acquiring the radiographs at both the table and at a chest bucky, in cases where both a table and a chest stand are installed in the same examination room. The positioning of this chest stand in relation to the patient table will depend on the size of

the room, the type of mounting used to support the X-ray tube and the X-ray tube's range of movement.

4.48 For floor-mounted devices where the X-ray tube support is integrated with the patient table, the central axis of the vertical bucky needs to be aligned with the central axis of the table bucky. It is advised that a minimum distance of 2 m is left between the base of the patient table and the face of the chest bucky.

4.49 Where room sizes permit, the positioning of the chest bucky in relation to ceiling mounted X-ray tubes is customarily offset from the centre axis of the patient table, for ease of access. Please also see the text on ceiling suspensions in Engineering Requirements, [Appendix 2](#).

X-ray generator and documentation cabinets

4.50 Usually two floor-mounted cabinets are installed within the general X-ray room, the first containing the kilo-voltage, high frequency generator equipment used to power the X-ray tube, with the second being a cabinet containing the equipment manuals, which should be stored within the X-ray room.

4.51 In some set-ups the generator may be installed underneath the X-ray table and this may be ideal where space is limited. Where rooms are installed back to back

Figure 4.2 Example of vertical bucky unit primarily for undertaking chest radiographs. Image supplied by Siemens Medical Solutions.

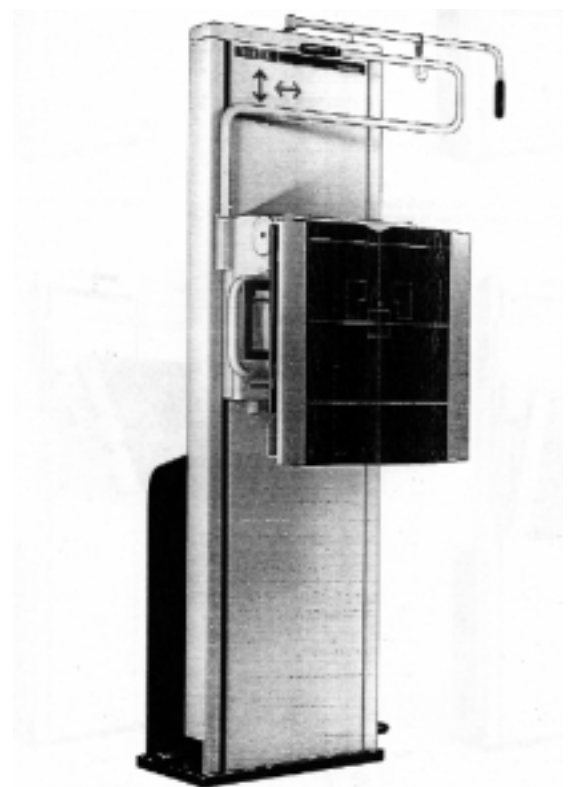

and divided by a lead screen instead of a solid structure, then it may be configured so that the generator could provide power to both X-ray tubes, thus allowing some space saving.

4.52 Emergency stop switches should be located close to the patient table in the examination room and within easy reach for the operator, in the control area, standing at the X-ray system control unit.

Other more non-specific general fixtures and fittings

4.53 Other more general fixtures and fittings will include the following:

- wherever the examination of seriously ill patients is envisaged, wall mounted piped oxygen and medical vacuum points should be provided within the examination area (that is, not within the control area). Anaesthetic gas points and AGSS are not required in general purpose X-ray examination rooms;
- general clinical handwashing facilities within the examination area. More extensive scrub-up facilities are not usually provided in general purpose X-ray rooms;
- general shelf and cupboard storage space for patient immobilisation devices, sundry items of QA equipment and other general medical supplies including linen. Storage of controlled drugs will not be required;
- wall-mounted hooks or hangers, for one or two lead aprons and other protective equipment such as lead-lined gloves. For general X-ray suites only, these should be located in the examination room;
- a maximum of two wall-mounted X-ray viewers within the examination area. If the hospital is no longer using conventional X-ray film then these will still be required as there may be a requirement to review old films or those from other hospitals;
- “pat-slide” patient transfer equipment;
- control console fittings; as described elsewhere under “control area”;
- mobile radiation protection lead-lined screens, which permit patients to be accompanied during their examinations. These are typically 2 m high when in use and are height adjustable for ease of storage and transportation. These are similar in appearance to the radiation protection screens used to shield the control area.

Control area

4.54 X-ray exposure settings, initiation of the X-ray examination and other parameters are typically set using a control console. This console is usually located behind an 0.5/0.5 opaque/lead glass radiation-proof screen, forming a separate control area within the general purpose X-ray examination room.

4.55 The control console should be placed behind a radiation-proof screen. This area is known as a control cubicle. The cubicle must provide radiation protection for the radiographer at the control console and for other staff and carers or relatives accompanying the patient, who maybe present during a radiological examination. It may also provide protection for access into an adjoining processing area. If the screen is located in front of the access to the processing facilities and fully protects the opening, a radiation-protected door need not be provided, subject to RPA advice. However, there may need to be a lightweight door for auditory and/or visual privacy.

4.56 The radiation-proof screen should have a lower section of solid construction to a maximum height of 1.1 m with an upper section of radiation-proof lead glass, which allows an unimpeded view of the patient at all times. The total height of the screen should be not less than 2 m from the finished floor level. The screen will be configured to allow easy access from the examination area and must not incorporate internal doors. Horizontal or diagonal bracing struts may be required to support head of the screen. The degree of radiation protection required can vary with circumstances. It is therefore essential to seek the advice of the radiological protection adviser on this aspect. However, for general X-ray rooms this usually equates to 2 mm of lead equivalent at energies of 150 kV.

4.57 A full width worktop is normally installed in conjunction with the radiation proof screen onto which the control console maybe mounted. Alternatively, some X-ray control consoles for general rooms may be supplied as integrated floor standing units for which space provision will need to be made. Vertical storage racking should be provided underneath the worktop for cassettes and radiographic anti-scatter grids. This should accommodate film X-ray cassettes up to 43 cm x 35 cm. The grids are of approximately the same size.

4.58 Wall mounted electrical distribution panels and main on/off switches and an emergency stop button will need to be provided in the control area.

4.59 The screen should be positioned relative to the patient table and vertical buckies to offer a good view of the patient when undergoing an examination.

4.60 Additional space for the location of a radiology management or information system computer, a bar code reader and printer to allow the printing or inputting of patient information should be allocated within the control area.

4.61 During an examination there may be up to two radiography staff present in the control area, possibly accompanied by other people.

4.62 The control console has the full range of controls and facilities necessary to provide the radiological exposure factors for the equipment with which it is associated. Control consoles vary considerably both in size and weight. Modern design tends to reduce the overall dimension and weight of the control console by housing the more bulky elements in separate electronic equipment racks combined within the generator in a single cabinet, which is normally sited within examination room.

CR option

4.63 A small CR plate reader (1 m³ approximately) can be installed within the control area, rather than within an adjacent processing area. In this instance the review and processing of images may take place within the control or examination area of the general X-ray room. Printing, reporting and archiving would take place elsewhere. In this instance, an adjacent relationship between the general X-ray room and the processing area is still important, as images may need to be laser printed. Some form of back-up should be available if the unit breaks down or requires routine maintenance.

4.64 Additional to the items described above, space will need to be allocated for the CR plate reader, a review workstation and related working areas.

DR option

4.65 For DR, the control and setting of X-ray parameters, and review of images is undertaken using a single computer workstation incorporating a 54 cm monitor or larger. The images are automatically acquired using the digital detectors integrated into the unit and the computers, which will be housed in the examination room, process the images. There still needs to be a direct adjacent relationship with a processing area as in the inflexibility of DR requires the use of CR or conventional film processing for non-bucky work. There also needs to be some form of back-up if the DR system breaks down or if parts of the system are undergoing routine maintenance.

4.66 The design of the X-ray tube and associated digital detector are completely different when compared to conventional X-ray tubes design and installation.

Figure 4.1 shows a typical unit.

Changing cubicles

4.67 Storage space will be needed for clean gowns. Linen skips should be conveniently located within the department for the disposal of used gowns.

4.68 Patient changing facilities must be provided close to the general X-ray room. For general X-ray facilities project teams should consider the following alternatives for changing facilities:

- a. individual changing cubicles adjoining the examination room and opening directly onto it;
- b. changing cubicles grouped together close to but not adjoining the examination rooms and combined with a sub-waiting area in which patients will wait, already changed prior to being escorted into the X-ray room.

4.69 Individual changing cubicles adjoining within the X-ray room design have advantages in terms of patient privacy and dignity and may achieve greater security of patient's belongings. This arrangement can also achieve faster patient throughput by reducing radiographer movements. A typical layout will allow two to three cubicles to serve a single examination room and one of the cubicles should be sized to allow wheelchair access and assisted changing.

4.70 Cubicles should have lockable inner and outer doors, where the inner door must be controlled from the X-ray room only by the use of thumb turn lock or similar device. This door must also be designed to provide protection from ionising radiation. Greater initial costs may arise from individual changing cubicles in terms of construction costs and possibly in terms of overall area requirements. A reduced extent of wall area will be available in the X-ray room for equipment cabinets and for wall-mounted diagnostic and other equipment. Each cubicle may also need to be fitted with patient/nurse call buttons and this may raise the costs involved.

4.71 Where changing cubicles are grouped together close to but not adjoining the examination rooms, cubicles will be of simple construction and cubicle access will be by individual doorway or curtain. After changing, the patient's belongings may be left in the cubicles, if they can be maintained securely, or patients may place their belongings in baskets, which they can carry into the examination room. In this latter instance, changing cubicles can be used more intensively, thus reducing the overall number required.

4.72 This system needs an increased sub-waiting area and may also involve a supervised secure storage location if the bags or baskets are not to be taken into the diagnostic rooms.

4.73 At least one of the cubicles provided must be sized to allow wheelchair access and assisted changing.

4.74 Review of examination and patient waiting and changing times leads to an approximate indication of two general cubicles per general X-ray room and one assisted or wheelchair access cubicle per general radiographic examination room. Where two or more general X-ray radiographic rooms are grouped together or the use of the “shopping basket approach” is made, then some economies of scale can be achieved.

4.75 This approximation must not be applied to other modalities or other types of X-ray rooms such as fluoroscopy/interventional suites. These are described elsewhere in this document.

Sub-waiting areas

4.76 The general character of waiting areas is in [Ancillary Accommodation, Chapter 5](#).

4.77 As an indication, three seats should be provided per changing cubicle within the sub-waiting area. If the shopping basket approach is used then this should be increased to five.

4.78 At least one disabled access WC should be provided within easy access of the sub-waiting area. Drinking water may be provided for patients and relatives.

4.79 Ideally, workflow should be planned so that in-patients are transferred from the wards directly to the X-ray examination room with no waiting involved. In practice, this is difficult to achieve and therefore provision will need to be made for such patients to wait outside the examination room in reasonable privacy and dignity, by means of a locally widened area of corridor or bed bay provision, with suitable screening. Additional similar provision for patients on trolleys may be required if one or more of the general X-ray rooms serve an A&E capacity. This may take the form of a holding area.

UNIQUE OPERATIONAL REQUIREMENTS AND FACILITIES – SPECIAL CASES

Trauma X-ray imaging equipment and special aspects of room design – DGH level

4.80 Reference should also be made to the Health Building Note 22, ‘Accident and emergency department in an acute general hospital’.

4.81 In all cases, at least two X-ray rooms will be required in support an A&E department, for reasons of downtime considerations and maintenance. The actual number required will depend on the size of the hospital, operational requirements, workflow and the catchment population served. Two models for the provision of general X-ray services in support of a wide range of A&E examinations are described below:

- a. General X-ray examination rooms may be provided within the A&E department, with their own separate processing and reviewing area distinct from a separate diagnostic imaging department. Such facilities will be similar to general X-ray rooms as described, but will be planned and designed to allow for easy and rapid movement of patients on trolleys and beds into and also within the examination room. It may not be possible to transfer the patient to the X-ray table, so space will be required for the X-ray to be acquired with the patient remaining on a trolley or bed. The radiographer may be required to place the trolley or bed in a variety of different positions in order to acquire appropriate radiographic projections and will need appropriate working space to accomplish this task.

Additional accommodation within the A&E department supporting such X-ray facilities may include:

- (i) processing facilities as described above. CR has a large advantage in respect of image post-processing, thereby minimising the number of retakes required. Because of this, the use of CR is finding greater use in A&E applications in the UK;
- (ii) a darkroom, if conventional film processing is used;
- (iii) radiographer staff rest room and overnight on-call accommodation, which may be shared with the other A&E staff;
- (iv) a reception area and office facilities, which may be shared with the main A&E department;
- (v) a patients’ sub-waiting area, which needs to accommodate at least three patients on trolleys and six seated patients;
- (vi) holding area for patients, particularly those from A&E or where the room is integrated with the A&E unit.

The advantages of this approach are:

- (i) immediate 24-hour A&E access to X-ray facilities;
- (ii) improved security arrangements within for the main diagnostic imaging department as the majority of this department can be closed during out of hours working. The exception in this regard is CT;
- (iii) improved personal security for X-ray imaging staff.

The major disadvantages of this approach are the potential duplication and under-utilisation of X-ray equipment, processing facilities and the space needed to accommodate them. However, this may

be reduced to some extent by using these A&E X-ray facilities to support related out-patient activities such as fracture clinics, which will then need to be located near to the A&E department.

- b. Alternatively, general X-ray facilities, serving A&E, may be integrated with the diagnostic imaging department, but will also be directly accessible from A&E department. In this case the A&E and diagnostic imaging departments will be planned to be adjacent to each other. Within the wider diagnostic imaging department, the general X-ray rooms and CT will need to be sited as close as possible to the A&E department, whilst taking into account other planning considerations such as the relationship with the fracture clinic for example.

The examination rooms will be used for the whole range of general X-ray examinations including A&E applications and as such the design of the rooms should reflect the characteristics mentioned above.

In addition, a holding area for seriously ill A&E patients as described above should be provided.

Appropriate arrangements should be made to allow 24-hour access to the general X-ray facilities supporting A&E, including CT and processing areas, whilst maintaining security for the remainder of the diagnostic imaging department, by the provision of locked doors and barriers. Arrangements, possibly including CCTV, will be needed to maintain the personnel security of radiography staff who may be working alone.

The advantages of this approach are good utilisation of equipment space and rooms with or little or no duplication of facilities. The main disadvantage is, on some occasions, restricted access to the facilities for patients attending out-patient appointments during times of emergencies. This may have the effect of increasing waiting times for examinations for these groups of patients.

Trauma imaging centres at tertiary level and larger DGHs

4.82 With the advent of Advanced Trauma Life Support (ATLS) mechanisms, departments in larger hospitals are adopting American models of care in trauma centres utilising specialist equipment policies and rules to improve care for seriously injured patients. To facilitate this new practice, emergency room design has to change considerably. The new designs combine trauma and imaging treatment facilities.

4.83 The trauma imaging and treatment facility should allow for poly-traumatised or severely injured patients to be stabilised and examined according to ATLS

guidelines, which include the use of diagnostic imaging within 20 minutes of arrival at the hospital.

4.84 X-ray CT is heavily used in the examination of trauma patients. The trauma treatment and imaging room should be located close to the CT suite, which, in large hospitals, may be dedicated for A&E examinations.

4.85 The facility may undertake 5000 to 6000 patient examinations per annum using these facilities. The majority will be A&E patients, but this number may also include planned orthopaedic attendance and all “out-of-hours” attendances. It is expected that, on average, the trauma imaging centre will treat at least one to two poly-traumatised patients per annum from road traffic accidents (RTAs) and other emergency situations. As it is likely that these situations will involve more than one patient, the trauma imaging and treatment should take on a multi-bay environment design and allow for the minimum of the treatment and imaging of four patients.

4.86 The combined trauma treatment and imaging room needs to be multidisciplinary in design and consideration needs to be given to the requirements of all the team members present who may be caring for the patient. Some of these requirements may conflict in design terms and a compromise may have to be reached in planning and design terms.

Multi-bay environment

4.87 In a multi-bay environment, the individual spaces could be divided by mobile X-ray shielded lead screens, part of which should incorporate lead glass. These screens should be at least 2.5 m high and 4 m wide. An example of this set-up is shown in Figure 4.3. They should offer a high degree of construction radiation protection of approximately 2.5 mm of lead equivalent at energies of 150 kV. This level of protection may allow the clinical trauma team to make use of mobile CT scanners, which are currently being made available by one or two manufacturers. The integration of this innovation may require some further changes to the design of the trauma imaging and treatment facility together with close attention to systems of work and the requirements of the IRR 1999. This innovation may be considered necessary where there is not space to provide a dedicated CT facility. The exact requirements should be discussed with a radiation protection advisor.

4.88 Alternatively, a multi-bay environment could be provided by the use of half-length partition walls which again will need to encompass radiation protection in their design by the use of lead ply or barium plaster to specifications outlined above. The fixed partition walls should be at least 4 m wide when measured from the adjacent wall to the centre of the room and at least 2.5 m high.

4.89 The X-ray screens or fixed partition walls should include storage for needles, dressings and other small clinical items, which are needed to hand when treating the patient. As space is at a premium in these bays, all equipment should be wall or ceiling mounted. In addition, space should be allowed at patient head end for a large/deep shelf for physiological monitoring equipment, together with piped oxygen, vacuum, anaesthetic services coupled with multiple power points and at least twin wall-mounted X-ray viewing boxes. If the X-ray images are acquired digitally and a suitable network is in place, additional space may need to be provided for a dual monitor computer workstation. The bay should also be equipped with local mobile screens for patient privacy, ceiling or wall mounted drip hanger bars and a wash hand basin together with a central adjustable ceiling or wall mounted examination lamp. Space should also be left at the foot end of screens to allow staff to move easily between bays. For protection during X-ray examinations, the staff will wear lead-lined aprons, possibly coupled with sterile theatre gowns. These lead-lined aprons should be located close to the entrance either outside or inside the room, depending on local policies. In some cases it may be necessary to mark off areas of the room to protect members of staff who are not wearing lead-lined aprons. This step should only be taken following consultation with the RPA.

4.90 The bays should be designed to allow for up to six members of staff to access the patient at any one time. An additional three or more persons may be present to assist in caring for the patient.

4.91 The patient trolleys will be of low X-ray attenuation design and incorporate horizontally mounted cassette holders for anterior/posterior or posterior/anterior X-ray views. In essence, the trolleys should meet the requirements of surgeons, anaesthetists, nurses and radiographers, who will make very different demands of the equipment.

4.92 Space should be allowed at the sides of the patient for a separate mobile trolley, incorporating an adjustable hinged fold-up cassette holder, which is used to facilitate lateral X-ray views.

Imaging equipment

4.93 A single ceiling-mounted mobile X-ray unit can be used to image all the patients who may be brought into the integrated treatment and imaging centre. An example of such a unit is shown in Figure 4.4. The X-ray unit should be mounted on tracks that allow the unit to cover all the bays within the combined trauma treatment and imaging room, and permit a full range of lateral and vertical X-ray examination projections. This may be achieved, as demonstrated in this example, by locating the unit on central twin tracks and providing an extensible/adjustable articulated and telescopic arm, which can be extended from the track position into each patient bay. The engineering requirements are similar to those for a conventional ceiling suspended X-ray tube, but the overall track length may be longer. The design of the room and the equipment should also minimise potential collisions between the X-ray equipment and other ceiling suspended equipment.

4.94 The positioning of generators and control panels are very problematic in multi-bay emergency trauma imaging and treatment rooms and consideration should be given to providing maximum length high-tension cables, using multi-exposure switches or control panels coupled with safety interlocking facilities or trolley mounted remote control units.

4.95 In addition, the use of a mobile ultrasound unit will be common, particularly where patients are being treated for abdominal trauma. A mobile radiographic unit may be used in place of a ceiling-suspended one as a standby measure when the main X-ray tube is being repaired undergoing routine maintenance or has broken down.

Image development processing

4.96 Images acquired in the facility will need to be developed within dedicated image processing facilities. The design of the processing facility will depend on the imaging approach. The use of CR may be advantageous in this regard for the reasons described in Imaging Approach, Chapter 3. The processing room should be sized to support the number of bays present and the designer should equate the requirements of one bay to be equivalent to a single general X-ray room. The processing area should be located directly adjacent to the combined trauma treatment and imaging room.

Shared facilities

4.97 Shared facilities with the main A&E department could include:

- stainless steel scrub-up troughs to the number required;
- storage space/worktops;

- clinical wash-hand basins;
- space for parking mobile ultrasound units;
- lead apron storage on mobile racks;
- trauma room monitored by CCTV camera(s);
- staff changing and showering facilities;
- office workspace;
- sub-divided waiting room space for relatives and carers of patients undergoing treatment.

Mobile radiographic systems

Introduction

4.98 X-ray examinations may be undertaken using small self-contained mobile X-ray units, which only require a standard one-phase power supply. They are used for acquiring X-rays on wards and in specialist areas such as ITU and CCU. These units are completely self-contained, with the X-ray tube mounted on an articulating arm, which allows for a number of projections. Images acquired from the use of these systems can be processed close to the ward, but more often, the cassettes are taken back to the processing area in the main department.

Potential challenges

4.99 Mobile X-ray units, by their very nature, are distributed to various locations around the hospital. This can give rise to issues when servicing these units and undertaking QA procedures. Imaging managers should be aware that undertaking these necessary tasks at remote locations could give rise to radiation safety hazards for both patients and staff and could violate the Ionising Radiations Regulations 1999 (IRR 1999) with respect to the Health and Safety at Work etc Act 1974. Additionally, service companies and medical physicists, who are unable to find units or who have to wait for safe working areas to be identified, may make additional charges for the extra time. The purpose of this chapter is to give guidance to department managers, in order for them to minimise risks to patients and staff and, where possible, avoid additional service charges.

4.100 Engineers, physicists or radiographers repairing or checking units, either from an external service provider or from an internal group, require a safe working environment to affect a repair or QA procedure. There are two main reasons why this is necessary:

- a. during a repair covers may be removed and high voltage components exposed. This will represent a hazard to hospital employees, patients and members of the public if a repair is made at the mobile's normal location, which may be a corridor or close to a ward area;
- b. due to their nature, almost all repairs or QA checks will require an X-ray exposure to be made either as

Figure 4.3 Example of a multi-bay layout for major A&E trauma unit in a tertiary referral centre. Image supplied by Royal London Hospital.





Figure 4.4 Example of a ceiling-mounted X-ray unit for use in trauma imaging centres and a multi-bay environment. Image supplied by the Royal London Hospital.

part of the repair or a functional test. Any exposure during a test or repair must be made in a controlled area under the IRR 1999. Any employer or department manager would fail in the duty under the IRR 1999 if they knowingly allowed exposures to be made in public areas.

Methods for overcoming challenges

4.101 The following guidance is given so that the issues described above can be minimised.

4.102 It is advisable to ensure that each mobile is clearly identified with a marking on the unit. A location board or some other tracking method within the department should be used to ensure that all staff can locate each mobile X-ray unit.

4.103 Faults with units should be logged, with details of the problem and the name of the person who identified the issue. The tracking device should identify faulty units.

4.104 When an operator identifies a fault on a unit or it requires a periodical QA test, it should be moved to a location that has been identified as being a controlled area under IRR 1999. Ideally, this would be within an X-ray department. This may take the form of an X-ray room, which may affect patient throughput, or, ideally, a specially constructed room within the department, incorporating radiation protection for undertaking tests on mobile X-ray equipment. The door and overall size of this room should be large enough to accommodate both mobile X-ray and fluoroscopic equipment for

testing and repair purposes. This room should also accommodate a suitable low attenuation small mobile aluminium table, which is placed between the X-ray source and the detector during the testing process.

4.105 If the unit is being repaired and it is not possible to move the mobile X-ray unit for any reason, the attending engineer should be escorted to the unit, with a senior radiographer or medical physicist supervising the repair activity. Consideration should always be given to engineers working on systems in remote locations, as these employees should not be working on systems unsupervised, in case an accident should occur. By their very nature, mobile X-ray sets are high electrical voltage units. Battery powered units have high voltage present even when the system is turned off. It is also not desirable to have contractors, who may not be correctly identified to members of staff, working on, or moving X-ray units unsupervised in locations remote from the imaging department.

4.106 QA procedures should be undertaken in radiologically protected room. Medical physicists and radiographers should co-ordinate these QA procedures with the superintendent radiographer or imaging services manager for the provision of appropriate facilities.

4.107 Repairs, servicing and QA of mobile X-ray units should always be made in a location that is both a radiation-controlled area and a supervised area such that engineers or medical physicists are not working alone. Reference should be made to both Health and Safety regulations and the IRR 1999. Most engineers will

complete a repair by making a functional test of the unit and this will invariably mean an X-ray exposure. Virtually all QA procedures will involve making X-ray exposures and these should be undertaken in a suitable area complying with the IRR 1999.

Skull X-ray systems and appropriate room adaptations

4.108 The use of skull radiography has almost been replaced in the UK by the use of X-ray CT. The majority of referrals are from patients who may have been admitted from A&E. It is observed that the numbers of radiographers who have received training and able to maintain competence in this area are decreasing due to the paucity of units and low throughput. Where it is suspected that the patient may have internal injuries as the result of a head trauma, then CT allows the clinician or radiologist to make the diagnosis with much greater certainty. As a result, few skull units are sold in the UK per annum and the number of examinations undertaken using this equipment is decreasing.

4.109 Skull radiography cannot usually be undertaken using general X-ray tubes, as those used in skull radiography have higher heat capacities and are able to image at much higher resolutions. The ergonomics of these devices permit a number of projections and views, which may not be possible with standard general X-ray equipment.

4.110 Skull units may be either floor or ceiling-mounted fixed devices but, in the majority of cases, are of isocentric design. However, ceiling supported skull units are not usually mounted on mobile ceiling tracks. The X-ray tube and cassette-holder are mounted on c-arms diametrically opposing each other. A number of movements are possible for the c-arm to allow the radiographer to achieve a number of radiographic projections.

4.111 The patient may be lying supported by an appropriate headrest, on the general X-ray table or sitting on a specialised chair during the examination. In some instances, where a specialist table is not provided,

it is advantageous to site the skull X-ray unit close to and in parallel to an end of the general X-ray table. In all cases the range of the movements of the skull X-ray unit should be integrated with those of the general X-ray tube to avoid potential collisions and damage to the equipment. Working space will also be required for the radiographer to easily operate the skull X-ray unit over its full range of movement to allow for the required projections. In essence, this should allow space for the radiographer to move easily on both sides of the equipment.

4.112 In the majority of cases, it may be appropriate to install one of these units in a general radiographic room, as this allows for both space and equipment saving. A single generator and control panel can be used to power and control both the skull and general X-ray units. It may be also be appropriate considering that the virtually all of referrals are will be from A&E and thus the equipment could be installed in rooms allocated for full or partial A&E use as described earlier in this section.

4.113 In some instances, such as specialist tertiary centre trauma imaging units, throughput and patient numbers may justify the provision of a skull unit in a separate imaging room. In this case a dedicated patient support will be provided with the unit which will be of similar design as that describe for general X-ray systems. Enough space should be left around the couch for the radiographer to set up a wide range of radiographic projections.

4.114 Skull X-ray units are usually supplied with a number of X-ray field alignment fittings, which are constructed of lead and attached to the front of the X-ray tube. A cupboard or similar storage for these devices needs to be provided within the X-ray examination room.

4.115 Ceiling suspended skull X-ray tubes will usually require specialist fittings in the form of a dedicated plate fitted directly to the underside of the ceiling slab.

4.116 This option will increase the space requirements within a general X-ray room. See the forthcoming schedules of accommodation, and Example plans, [Appendix 1](#).

5 Facilities for universal fluoroscopy and remote fluoroscopy systems

BACKGROUND

5.1 These units are used to acquire moving images in almost real time to examine anatomy and physiological processes. As in general X-ray radiography an X-ray tube is used in the image generation system. An X-ray image intensifier is used as the receptor device and working in conjunction with a TV camera is capable of acquiring analogue or digital moving images in “real” time. The images are then viewed on monitors, located in the examination and control areas. The use of this device allows images to be acquired of both human physiology and anatomy. Diagnostic investigations using an image intensifier will usually be carried out in conjunction with contrast media for a range of investigations as described below.

5.2 X-ray fluoroscopy, also known as screening, provides continuous real-time imaging, not all of which is recorded. However, still or moving images may be captured to form a record of the examination. In all examinations fluorography will be used in conjunction with fluoroscopy. Please refer to the [Glossary](#), Appendix 3, for a description of fluoroscopy and fluorography.

5.3 According to a fixed protocol, the operator (either a radiologist or radiographer), by means of dedicated apparatus, may record the images from the intensifier using digital acquisition methods. This process is called X-ray fluorography or digital spot imaging by some manufacturers and many images may be acquired per second (up to 50 fps) as a movie or still images. See the [Glossary](#), Appendix 3, for further details.

5.4 This chapter focuses on the built environment requirements for universal and remote X-ray fluoroscopy/fluorography diagnostic imaging equipment. The installation and design requirements for these units are similar and thus described under the same section. This should not be confused with facilities required for multi-angular c-arm equipment used in vascular and non-vascular imaging and interventional work.

5.5 The primary difference between universal and remote equipment relates to how it is operated. Universal fluoroscopy/fluorography equipment is operated by the radiographer or radiologist at the side of the patient using controls mounted near the patient couch. All movements of the equipment will be

controlled together with fluoroscopic and fluorographic exposures. For remote control equipment members of staff will be present in the control area during the procedure and will not usually enter the main part of the examination room during exposure of the X-ray tube. Better patient compliance during an examination is usually achieved with universal fluoroscopy equipment and thus this is more commonly procured for the types of procedures described below.

CLINICAL AND OPERATIONAL OBJECTIVES FOR UNIVERSAL AND REMOTE FLUOROSCOPY/FLUOROGRAPHY IMAGING SYSTEMS

Contrast media – general introduction

5.6 Contrast media are chemical substances, which are manufactured to be relatively non-toxic for the majority of patients undergoing diagnostic imaging examinations. Modern radiology makes use of contrast media with all imaging modalities including MRI, ultrasound and CT. Contrast media are administered to enhance and improve the contrast characteristics of the images acquired in diagnostic imaging examinations. In some instances, the use of contrast media permits the imaging of anatomy or physiology not normally seen in standard imaging procedures. Contrast media, which may require preparation before being used, can be administered orally, intravenously and rectally, particularly for barium enema studies. Contrast media are heavily used throughout virtually all procedures involving the use of X-ray fluoroscopy.

5.7 Two of the commonest contrast substances in common use are iodine, for imaging the systemic circulation, and barium, for imaging the digestive tract. The timing of the delivery of the contrast media in conjunction with the X-ray imaging can be critical to the successful completion of the study. Such examinations are usually achieved with the use of integrated automated injectors and these are described below. In a few instances the patient may suffer an allergic reaction to the administration of the contrast media either during or just after the procedure. In the majority of cases patients may be asked to remain within the waiting area for a period of time following the examination and may be given further information when leaving the hospital.

Barium contrast procedures

5.8 Contrast media is used to acquire physiological and anatomical images of the whole human digestive tract from the oesophagus to the rectum. The procedures are undertaken using barium compounds as the main imaging contrast media. Studies include barium enemas, swallows and meals, and “follow throughs”. These are briefly described below.

Barium enemas

5.9 One of the most important clinical indications for undertaking barium enemas relate to the presence of gastro-intestinal polyps, which in the long run may cause colorectal cancer. Consideration is being given to providing a screening programme for at risk individuals.

5.10 Following appropriate bowel preparation, the majority of the upper and whole of the lower intestines are filled with barium via a rectal catheter. X-ray fluoroscopy is used to monitor the progress of the contrast media as it moves through the lower portion of the digestive tract. Tilting the patient on the integrated patient table, X-ray tube and image intensifier may facilitate the movement of the barium compound within the intestine. Images are acquired using the digital fluorographic facilities of the equipment at discrete intervals throughout the study to demonstrate pathology or a normal study. This part of the examination may take five to ten minutes and is usually followed by injection of air to enable “double contrast” studies to be made. The injection of air enables the barium to stick to the inner lining of the intestine so that the intestine wall can be imaged. The patient may then go to a conveniently adjacent WC, to evacuate some of the barium, after which further digital fluorographic images may be acquired. Following the examination the patient may need to rest before going home or visit a WC to evacuate any further barium that may remain in the lower intestine.

5.11 Parts of the procedure require lateral exposures to be undertaken. The design of the equipment makes this part of the procedure impossible and as such the main equipment has been supplemented by a ceiling-suspended X-ray tube and the images are acquired using conventional or CR radiographic technologies as described in [Imaging Approach, Chapter 3](#). The radiographer may need to place the X-ray tube either side of the couch to achieve this objective and the room should be designed to allow for this possibility.

Barium swallows and follow-throughs

5.12 This diagnostic test is used to for problems, such as difficulties in swallowing in the upper gastrointestinal tract (throat and oesophagus). The patient swallows the barium contrast media whilst standing on the foot-plate

of the tilted table. Images are acquired as the contrast media is swallowed and moves through the throat and oesophagus. This examination may be combined with a follow-through where images are acquired as the barium contrast media moves through the whole of the upper gastrointestinal system, that is, the stomach and the duodenum portion of the small intestine. The purpose of this latter part of the study is to look for problems behind symptoms such as recurrent heartburn and bleeding. This may require the patient to spend long periods in the diagnostic imaging department.

Micturating cystography

5.13 The purpose of this examination is to look for renal and bladder problems, particularly those associated with obstructions, constrictions and reflux, where urine may flow back to the kidneys from the bladder during micturation.

5.14 Whilst the bladder is filled with contrast media via the urethra, the progress of media to the bladder is examined using fluoroscopy and images are acquired at appropriate points of the investigation with the contrast media in the bladder or while the patient is micturating. The purpose of the examination may be to look for renal reflux where the urine moves back into the kidneys from the bladder during micturation. The challenge in design terms is to ensure patient privacy during the examination and that the environment supports what can be a difficult and challenging examination for the patient and members of staff supporting the procedure.

5.15 This procedure is sometimes implemented in paediatric patients up to the age of two, but in the majority of paediatric patients above this age has been replaced by the use of radionuclide imaging. The procedure is still used extensively in some groups of adults. Additional complementary diagnostic tests may be undertaken at the same time, resulting in a requirement for a slightly larger room.

Post-mortem work

5.16 Fluoroscopy imaging equipment to acquire X-ray images of cadavers may be used to support post mortem work undertaken by coroners in the mortuary. These procedures will usually not be undertaken during normal or extended working, that is, when patients are present. Special considerations in this regard will include maintaining a clean environment for patients to be examined the following day and coping with emergencies where patients may need to be examined when a cadaver is being imaged. It is probable that this area will expand and future revisions of this guidance will include more information relating to the use of diagnostic imaging in post-mortem studies. For radiation protection reasons, the use of remote rather than

universal fluoroscopy/fluorography equipment is preferred for this application.

Endoscopic Retrograde Cholangiopancreatography (ERCP)

5.17 In this imaging examination, the morphological or anatomical aspects of the pancreatic and biliary ducts are imaged. This is usually undertaken with some gastrointestinal endoscopy. However, except when contra-indicated, imaging ERCPS are gradually being replaced by Magnetic Resonance Retrograde Cholangiopancreatography (MRCP) for diagnostic purposes. ERCPs are still used for interventional procedures where, for example, the objective is to place a small stent and open up a partially occluded biliary tract.

Hysterosalpingography (HSG)

5.18 This test is still considered the gold standard for demonstrating fallopian tube patency and establishing the possibility of infertility or ensuring the success of sterilization procedures. The examination involves injecting contrast agent into the fallopian tubes and imaging the resulting distribution. The nature of these examinations makes it necessary to maintain patient privacy and dignity at all times. The designer of the suite should consider this objective in planning the suite. This examination has been partly replaced by hysterosalpingo contrast sonography (ultrasound) with the introduction of ultrasound compatible contrast agents and wish to move away from an ionising radiation technique. This examination can also be performed using non-vascular interventional imaging equipment as described below.

PATIENT JOURNEY

5.19 Please refer to Imaging approach, Chapter 3, for diagnostic image handling and processing, with respect to patient journey aspects during processing and checking. Please also refer to the PACS supplement (forthcoming).

5.20 Patients may be referred for a procedure examination as out-patients by a GP, by appointment as a consequence when attending an out-patients clinic, as an in-patient transferred from the ward areas of the hospital. Out-patients will usually be attending by appointment, either directly at the diagnostic imaging department, or from another out-patient speciality clinic requiring diagnostic imaging support. A member of the administrative support staff will enter the details from the request form into the Radiology Information System, before the patient attends for his/her procedure. With the appointment confirmation the patient will be sent details of the examination together with information on preparation procedures and proscriptions.

5.21 Patients may attend for their examination either on foot, in a wheelchair, or in a trolley or bed. The doorway entrance used for patients must allow access for King's Fund Beds with accessories such as drip stands and other monitoring equipment. The majority of patients attending for the types of procedures described above will be out-patients.

5.22 Patients attending for these types of procedures will need to be fully undressed, and changed into a hospital gown. There is a need to maintain patient privacy and dignity at all times. Planning arrangements for the provision of patient changing and waiting facilities are described in more detail above.

5.23 Due to the design of the equipment, there are limitations on the minimum height for the X-ray table. Ambulatory adults will be able to transfer themselves to the X-ray table. It may be necessary to provide facilities to enable staff to position patients for their examination. Disabled or elderly people may find it difficult to transfer to the patient table, so steps and a Pat-slide should be made available in the room. The use of a patient hoist should be considered and shared with other modalities in the department.

5.24 The majority of procedures will take between half an hour and an hour depending on complexity. These times do not include changing, preparation procedures or transfer. In some cases, for example during barium follow-up studies, the patient will have to remain in the department for the majority of the day and the facilities should be designed to allow for this clinical investigation.

5.25 A barium enema can be a very unpleasant experience. Patients may be sick and will need to use the WC immediately following the procedure. A WC with wheelchair access, incorporating a bidet and douche, should be integrated into the fluoroscopy room or sited directly adjacent to the facility.

5.26 Patients may be sedated during some procedures, with the sedatives administered before the examination. In the case of in-patients, sedatives may be administered on the ward and recovery may also take place in the ward. General anaesthetic will generally not be required except for paediatric patients and where hysterosalpingography (HSG) procedures are undertaken. In the latter case, this can be a difficult and relatively painful procedure for the patient and recovery space should be allocated. The recovery area could be shared with those allocated for other X-ray fluoroscopy modalities.

5.27 For barium procedures, the patient will receive the barium whilst in the examination room. The barium mixture will be prepared either in the room or in an adjacent preparation room.

5.28 Following completion of the examination, out-patients will change to outdoor clothing and discard the gown into an appropriate receptacle. They may remain in the sub-waiting or recovery area under observation until they are deemed ready to depart. During this time the patient may need to visit a separately provided conveniently accessible WC.

5.29 In-patients will return to the ward, possibly on a bed or trolley. Patients' relatives will usually remain in the main waiting area during the examination.

5.30 Please refer to Figures 5.1 and 5.2 and Appendix 1 for conventional and remote fluoroscopy rooms.

LIST OF ACCOMMODATION

5.31 The schedule of accommodation in support of a general screening room should be follows:

- an examination room containing conventional or remote, U-arm/table unit, a ceiling suspended X-ray tube, ceiling- or floor-mounted monitors and possibly vertical stand or bucky;

- a control area shielded by the use of fixed lead radiation proof screens. This may take up a portion of the examination room or may be a separate area;
- a small area outside the examination room for the lead aprons;
- barium preparation facilities;
- a dirty utility/disposal area;
- a dedicated disabled access toilet directly accessible from the examination room;
- a processing area to develop the films. This could be shared with facilities to support general X-ray rooms, but the suite should be adjacent to the processing area;
- sub-waiting areas for both out-patients and, where appropriate, in-patients;
- changing cubicles for patients;
- toilets for use by the patients and accompanying relatives before and after the examination;

Figure 5.1 Example dimensions for a conventional/universal fluoroscopy unit. Image supplied by Siemens Medical Solutions.

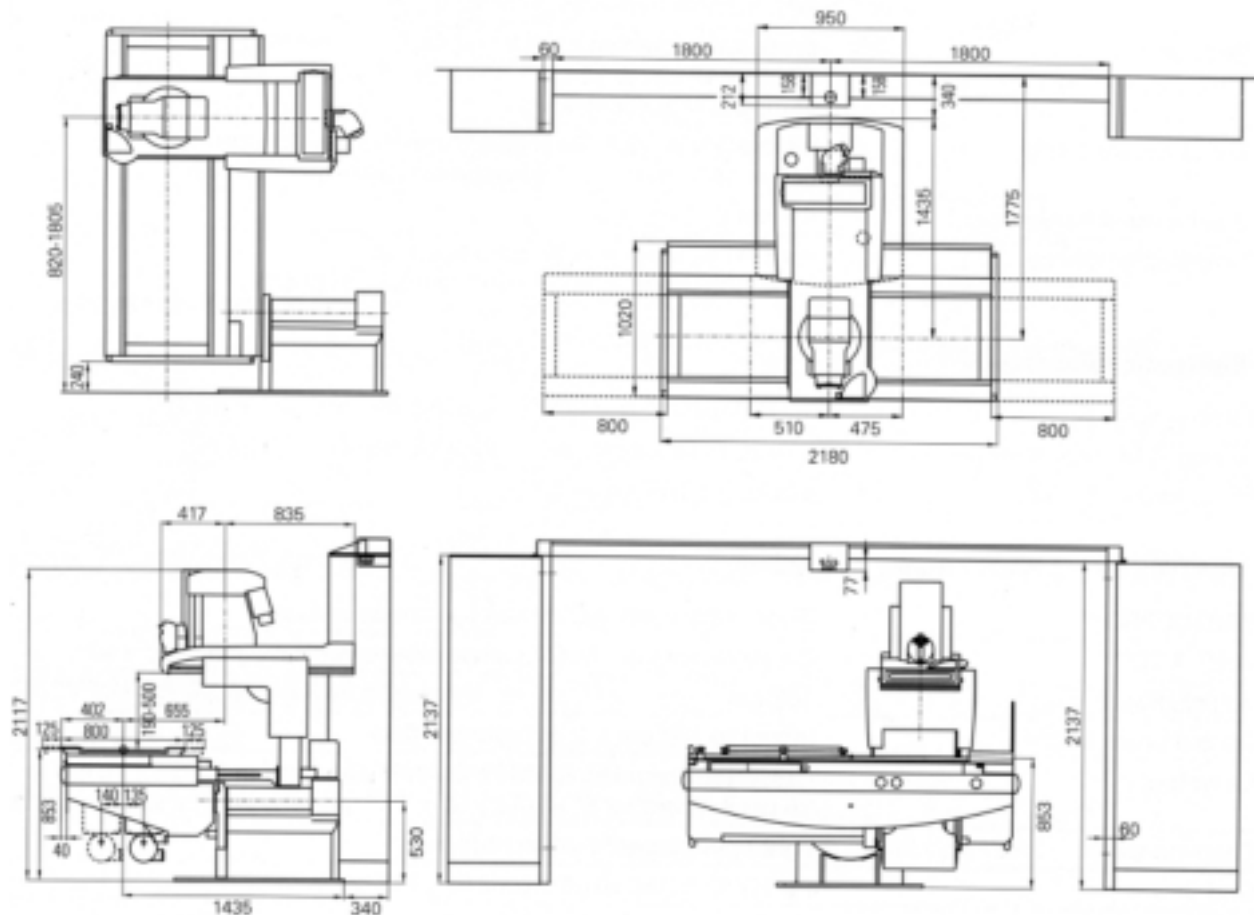



Figure 5.2 Example image showing main components of conventional/universal fluoroscopy unit. Image supplied by Siemens Medical Solutions

- other accommodation which may be shared with other modalities in a larger diagnostic imaging department are described elsewhere but listed for reference purposes;
- a porters' base to assist with the transfer of patients to and from the wards;
- a counselling room;
- a main reception area for patients;
- a shower room for patients who have soiled themselves. The room should be sized to accommodate trolley-bound patients and located close to the fluoroscopy room;
- two-bedded recovery to observe patients following some types of examinations, particularly HSGs.

ROOM AND EQUIPMENT DESCRIPTIONS

Examination room area

Main equipment aspects

5.32 This section focuses on the installation requirements for generic equipment, which have similar clinical applications and installation requirements. Where there are subtle differences these are noted appropriately.

5.33 For these types of equipment, the image intensifier and X-ray tube are mounted in a fixed U-arm relationship above and below the patient table. According to the particular equipment, the image intensifier may be mounted above the patient couch with the X-ray tube below; or this relationship may be reversed. The type of equipment procured will have a direct effect on the mode of operation. For equipment where the image intensifier is mounted underneath the



Figure 5.3 Main components of a remotely controlled fluoroscopy unit. Image supplied by Siemens Medical Solutions.

table, the unit will be operated by a radiographer from the control area in the majority of circumstances. Where it is mounted above, the radiographer will operate the unit at the side of the table using controls mounted in the U-arm. These will be referred to as remote and conventional fluoroscopy units in the text below.

5.34 A device known as an explorator is used to assist in the imaging procedure by supporting the image intensifier, incorporating movement and imaging controls, together with an X-ray cassette bucky and radiation protection in the form of flexible lead-lined strips. This equipment is “bulky” and is only common to conventional and remote fluoroscopy units. This may inhibit the use of this equipment with certain categories of patient, such as small paediatrics, who may be slightly intimidated, as they will be enveloped by the explorator during the examination. For such patients barium studies may be undertaken using multi-angular C-arm equipment.

5.35 As part of some examinations, for example for lateral exposures, the combined X-ray tube and image intensifier does not support the intended radiographic projection; general radiography will still be required and thus a ceiling suspended X-ray tube will need to be installed.

5.36 The table is integrated with the U-arm, which is floor mounted and served by a combination of surface mounted and under-floor cable trunking. Viewing monitors can be either floor-mounted on trolleys or on mobile stands or ceiling-mounted on mobile tracks. It is customary to provide a maximum of two monitors within this type of X-ray room and a single further review monitor in the control area. It may be better to allow for trolley-mounted monitors, as the alternative ceiling mounted devices may conflict and collide with the ceiling-suspended X-ray tube mentioned above. For trolley-mounted devices, consideration should be given to the ergonomics of loose or flexible cabling.

5.37 The movements of the integrated table and U-arm assembly for both remote and conventional fluoroscopy units are motorised and the whole assembly can be tilted by 90° in each direction, so that the patient may be rotated to a standing position during part of the examination. This is sometimes known as Trendelenburg tilt. In addition, the table and the U-arm can be moved longitudinally and laterally, independently of each other, in order to allow different segments of the gastrointestinal tract to be imaged, for example. Room space provided must allow for this range of movement at both ends of the table.

5.38 The ceiling-suspended X-ray tube is normally parked to one side of the room and cannot be activated or used until the U-arm is parked and vice versa. The U-arm can be parked behind the table, so sufficient space should be provided to facilitate this operation. A single generator cabinet located within the examination room would be used to power both X-ray tubes.

5.39 One of the important clinical uses of the ceiling-suspended X-ray tube is to obtain lateral or decubitus exposures with the patient lying on the couch during barium enema examinations. Space should therefore be left either side of the couch to allow the radiographer to obtain lateral projections from either side of the patient. As a minimum, enough space should be provided to allow the radiographer to achieve a projection distance of at least 1m, which is measured from the centre of the X-ray tube to a cassette placed the other side of the X-ray tube. The cassette will be supported by a lateral cassette holder, which is integrated with the main equipment. In some room designs, the position of the control area may conflict with this objective. It is advised that where this may occur, at least 1.75 m is left between the edge of the table and the lead-lined screens forming the control area.

5.40 In the majority of installations, space should be allowed for four cabinets in total, comprising one for the manuals, one for the DSI or fluorography, and two for the generator and power distribution unit. The DSI cabinet may be located in the control area, but space considerations may dictate that the others are stored in the main examination area.

5.41 Although not required for fluoroscopy/fluorography procedures, a chest bucky may be installed into the screening room to back up the facilities already located in other general X-ray rooms. In small hospitals, where the department may only consist of one X-ray room, this type of room may be installed to provide for a wide range of radiographic and fluoroscopic procedures.

5.42 As an option on some types of conventional equipment, the ceiling-suspended tube may allow for tomographic examinations working with a table bucky.

The design of the room, together with the installation, will need to allow for the X-ray tube to move 40° of subtended arc about the centre of the table at a distance of 120 cm.

General design features

5.43 Please also refer to the plans in [Appendix 1](#).

5.44 The room should be designed to allow the radiographer or other members of staff to easily see people entering the room from the main patient entrance doors.

5.45 It should be possible to lock the patient entrance doors during some procedures for patient privacy reasons and this should be achieved by the use of thumb locks to enable access during a fire. The patient doors should open inwards to the examination room to provide radiation protection for persons entering the room during a procedure inadvertently.

5.46 There may not be a requirement for a lead-lined door at the entrance to the control area but this will depend on the designation of the area and the radiation dose present. Advice from the RPA should be sought in this matter. In the majority of cases, the lead-lined screens provide adequate radiation protection, so no such measures are necessary. However, it is advised that a door, possibly of sliding type design, to the entrance of the control area is provided for patient privacy reasons particularly when HSG and micturating cystography examinations are undertaken.

5.47 The occupancy factors for procedures undertaken in this area may be up to seven persons, but this will almost certainly increase if ERCP procedures are undertaken. The people involved may include a radiographer, a radiologist, an anaesthetist, up to two assisting nurses and, where teaching functions are undertaken, up to three students or visitors.

5.48 Enough space should be provided within the front of the table to ensure that they can be transferred from a King's Fund bed.

Ancillary equipment

5.49 The general layout and the location of major equipment and provision of fixtures and fittings will be similar to that described for a general X-ray suite, with the exception of the points listed above and below which will necessitate a larger facility:

- a. direct access to an adjacent WC or via a private lobby;
- b. the type of X-ray equipment installed, that is, the fluoroscopy U-arm together with a ceiling-suspended X-ray tube which may be capable of tomography and

- may be used in conjunction with a chest stand if the suite is planned for additional applications or as a multi-use stand alone facility;
- c. the use of monitors either ceiling- or preferably floor-mounted. In the case of floor-mounted devices more space will be required;
 - d. additional space required for barium and patient preparation lay-up trolleys;
 - e. lead aprons and protective clothing should be stored outside the examination room, either within the control area or adjacent space near the patient or staff entrance;
 - f. additional storage facilities for contrast media such as barium. If a separate area for barium contrast media preparation is not available, then space for this preparation should be allocated in the main examination room. This will include storage space; worktops and a provision of stainless steel washing sink should be considered;
 - g. increased floor loading from the floor-mounted X-ray units;
 - h. during barium procedures there may be up to five clinical staff present in the examination room at any one time;
 - j. if ERCP or other clinical procedures using endoscopes or gastroscopes are conducted in this suite, then additional space should be allocated for additional endoscopy trolleys, associated equipment, video recorders, etc. and up to six clinical staff in the examination room. These procedures do not involve the use of barium contrast and X-ray fluoroscopy/fluorography is used to guide and record the position of the endoscope and any interventional procedure that may be undertaken. The majority of equipment used for endoscopic procedures will be brought in from outside the diagnostic imaging department and will be returned for preparation and sterilization.
- Appropriate workflow procedures and working space should be implemented and allocated for the return of dirty re-usable medical devices;
- k. mobile "skips" for the collection of soiled linen before cleaning and other clinical equipment either for disposal of single use devices or for return to an SSD for cleaning and sterilization. The latter will only apply for re-usable medical devices;
 - m. the floor finishes, wain skirtings and wall finishes will need to be resistant to splashing from barium and other contrast media and should therefore be designed to be impervious and easily cleaned;
 - n. the engineering requirements for screening rooms are similar but subtly different to those described for general X-ray rooms and these are described in [Engineering requirements, Appendix 2](#).
 - p. oxygen and vacuum should be provided in the examination room, and the project team should consider the use of piped anaesthetic and scavenging facilities. However, except where high volumes of paediatric patients are examined, the use of mobile trolley units may be more appropriate.
- ### Control area
- 5.50** This will be of similar layout and construction to the area for general X-ray suites, but will need to be made longer to incorporate greater amounts of control and monitoring equipment. It should be noted that remote units may require a larger control area and a smaller examination room area, where the opposite may be true for universal fluoroscopy equipment. This is for the reasons described above the differences in how the equipment is operated. In addition to the equipment described for the general ray control area, the following should be allowed for:
- a. a monitor together with an imaging computer and user interface;
 - b. possibly a video recorder and storage for blank videotapes;
 - c. in some cases storage for CD-ROMs may need to be provided as described above;
 - d. the DSI computer cabinet if not located in the X-ray room;
 - e. space to accommodate intermittently up to four clinical staff;
 - f. lead apron storage as described above;
 - g. an outer door possibly of normal construction for reasons of patient privacy.
- 5.51** The control area should be designed to allow a good view of the patient through all possible movement positions of the equipment. This is of particular importance in remote fluoroscopy rooms, where the radiographer will be sitting at a control desk within the shielded part of the room.
- ### Imaging reporting/approach
- 5.52** Some procedures, such as barium enemas, may be undertaken by a radiographer working to a set protocol without the presence of a radiologist. Reporting will be carried out by a radiologist to a pre-determined set of fluorographically acquired images. Other slightly more complicated procedures will require a radiologist

or other medical consultant to be present in order to clinically supervise the procedure. The radiographer/radiologist will review and possibly alter the contrast characteristics of the images acquired, directly after the examination, using the imaging computer. The results will be laser printed, sent to another post processing computer workstation, or sent to another digital archive for reporting at a later date. Further details of these options are described in Imaging approach, Chapter 3. Where the results are sent directly to another workstation it may be possible to integrate them with any radiographic images acquired, possibly using CR, and then save the complete study to a CD-ROM. Where this is undertaken, storage space should be provided in the control area of the fluoroscopy room to facilitate this process. The post processing imaging workstation should be located in either a small room adjacent to the fluoroscopy imaging room or within the processing area, particularly where CR is used in preference to conventional film.

Barium preparation area

5.53 The barium will be delivered to the department in 5 kg bags in powder form. It is made into a paste or viscous liquid by the addition of water by the radiographers or assisting nurse and given to the patient. For oral preparations, standard food hygiene measures will apply. Barium contrast media may be prepared within the examination room as described above or in a separately divided but directly adjacent space, if available.

Disposal of barium contrast media

5.54 Any unused barium cannot be disposed of using conventional sinks and drainage, so a sluice sink should be provided within a dedicated or shared dirty utility. Other fittings in this dirty utility room will include worktops with an inset sink, underbench storage space and wall mounted shelving. Please also refer to the [Engineering requirements, Appendix 2](#).

Dedicated disabled access toilet

5.55 This should have direct access for patients immediately following examination procedures, either via a door opening off the examination room or off a private dedicated lobby area. This room will include a bidet and

a toilet. Particular consideration should be paid to the design of the drainage to minimise the risk of drain blockage by contrast media. In planning this WC, consideration should be given to a second door acting as an exit, opening adjacent to the changing cubicles. In this case, the inner door to the examination room must be lockable, under the control of the radiographer and lead shielded for radiation protection reasons.

Sub-waiting area

5.56 The general character of waiting areas is described in Ancillary patient accommodation, Chapter 15. Since patients may have to remain in this area for extended periods of time, the area should contain basic refreshment facilities such as a water fountain, a television and magazines or books. Windows and an attractive outlook should be provided, if possible, in this area.

5.57 As an indication, six seats should be provided per general or remote fluoroscopy room where the shopping basket approach is used.

5.58 At least one disabled access WC should be provided adjacent to the sub-waiting area. This will be required by patients who may have received a barium enema and may be in the waiting area recovering from last effects of sedation.

5.59 As an examination may last between a minimum of 20 minutes and one hour, attendance by in-patients who may be transferred will be planned in advance and a single bed/trolley bay should be provided in the sub-waiting area. This should be capable of being screened by cubicle curtains.

Changing facilities

5.60 The changing cubicles should be grouped close together, but not adjoining the examination rooms, and combined with a sub-waiting area in which patients will wait, already changed, prior to being escorted into the X-ray room. As an indication, two cubicles should be provided for a single general fluoroscopy room and one of these should allow for wheelchair/assisted changing. The design will be as for the second option described under general X-ray facilities.

6 Fluoroscopy equipment for vascular and non-vascular imaging and interventional procedures

INTRODUCTION

6.1 This type of fluoroscopy equipment will be suitable for a DGH that does not undertake cardiac or other specialist imaging facilities and tertiary referral centres. This equipment will be used for a range of general vascular and non-vascular imaging and interventional procedures. Some of the clinical procedures that may be undertaken using this equipment are described below. Please note that some of those described are performed currently only in specialist tertiary referral centres.

6.2 The procedures undertaken with this type of equipment and in these suites have undergone radical changes in the last five to ten years with the increase in the number of interventional radiology procedures and the use of MRI and CT to undertake angiographic imaging. The majority of procedures undertaken in these suites involve some degree of intervention. The complexity of these procedures and their invasiveness are likely to increase as medicine advances. Therefore the suites to support these procedures with this equipment should be designed, as far as possible, to meet operating theatre standards, in terms of hygiene and suite design. The requirements to meet this objective are outlined in Engineering requirements, [Appendix 2](#). The accommodation aspects are further described below.

CLINICAL AND OPERATIONAL OBJECTIVES

Examples of non-vascular imaging

HSG

6.3 A description of an HSG facility is made in Chapter 5 under universal and remote fluoroscopy/fluorography facilities.

ERCP

6.4 The majority of imaging ERCPs are undertaken using MRI, except where contra-indicated and are commonly known as MRCPs. X-ray fluoroscopy procedures are commonly used to support interventional ERCPs, which are described below.

Back-up facilities for barium studies

6.5 In some instances, the room could be used to undertake barium contrast studies, such as those

outlined above, when the conventional or remote fluoroscopy room is being upgraded or repaired. In addition, some paediatric patients may find the use of an over-couch explorator, as described for conventional fluoroscopy units claustrophobic, making this type of equipment appropriate, if a remotely controlled fluoroscopy system is not available.

PTC

6.6 This is described in the [Glossary, Appendix 3](#).

Examples of non-vascular intervention

Image guided biopsy work

6.7 In order to permit successful cancer treatments, it is necessary to provide a full diagnosis of the tumour type. This can only be obtained by histological analysis of the actual tumour cells. This can only be acquired by obtaining actual samples from the tumour and is undertaken by needle biopsy interventional work. In this procedure, a sample is obtained directly from the tumour by inserting a needle into the patient under imaging control. The use of real-time X-ray imaging with this type of fluoroscopy equipment should make the whole procedure safer and more efficacious, allowing the clinician to view the needle in more than one dimension. In some cases, the sample will need to be prepared directly after the procedure for further analysis and a small amount of space may need to be allocated in the room for this operation. These procedures can sometimes be painful and the patient may be placed under sedation, local or in some cases general anaesthetic. Complications can also develop following some of the procedures, therefore patients will need to recover and be observed before leaving the hospital.

GI stenting (oesophagus, duodenal, rectal)

6.8 This procedure is undertaken when parts of the gastrointestinal system have become obstructed or occluded (stenosis), possibly as a result of another pathology. One of the common causes recorded in the medical literature is the presence of cancer close to the oesophagus or abdomen, which may be pressing directly against an adjacent area of the gastrointestinal tract therefore causing an occlusion or obstruction.

Where the actual cancer is too far developed to be treated, then stenting may be considered as a palliative measure to improve the patient's quality of life.

6.9 In this procedure, the imaging unit is used to guide a hollow, metal cylindrical gauze-like but firm structure that will be placed at the stricture of the gastrointestinal system to overcome the stenosis and improve the function of the GI system. For procedures in the abdomen, the use of ultrasound imaging working in combination with the fluoroscopy unit may be considered necessary.

6.10 Further examples of non-vascular interventional procedures are as follows:

- nephrostomy and ureteric stenting;
- biliary interventions (drain insertion, biliary stenting, stone removal);
- transjugular liver biopsy;
- TIPS;
- Hickman/Tessio line insertion.

6.11 The above procedures are described in the [Glossary, Appendix 3](#) under 'Basic descriptions of interventional radiological procedures'.

Examples of vascular imaging

6.12 The majority of angiography imaging is now undertaken using Magnetic Resonance Imaging, particularly with the introduction of new technologies and the increased use of contrast media in MRI. However, some work, for example femoral and renal angiograms (which have been replaced largely by MRI), is still undertaken in X-ray fluoroscopy facilities. Patients contra-indicated will still be imaged conventionally. Some patients may undergo X-ray angiography post-MRI, prior to interventional procedures.

6.13 Examples of angiography examinations are as follows and are described in the [Glossary, Appendix 3](#):

- venography;
- fistulogram.

Examples of vascular interventions

6.14 The following are all examples of vascular interventional work carried out by this equipment and are described in the Glossary.

- balloon catheter angioplasty;
- stent placement;
- IVC filter insertion;

- cardiac pacemaker insertion.

6.15 See the [Glossary, Appendix 3](#), for details.

Embolisation of bleeds, tumours, aneurysms, AVMs

6.16 See the [Glossary, Appendix 3](#), for details.

PATIENT JOURNEY

6.17 Please also refer to [Imaging approach, Chapter 3](#) with respect to patient journey aspects during processing and checking. Please also refer to the PACS supplement (forthcoming).

6.18 Patients may be referred for an imaging or interventional procedure either as a day-case (out-patient) by appointment, or as an in-patient transferred, from the ward areas of the same or different hospital. The latter may apply in specialist cases. Although appointments are generally made for these procedures, due to the nature of the work patients are often referred as emergency cases, possibly directly from Accident & Emergency.

6.19 The majority of patients undergoing this type of procedure will be in-patients, although some will be undertaken on a day patient or case basis and provision for a day case ward within or adjacent to the radiology department should be considered.

6.20 A member of administrative support staff will enter the details from the request form into the Radiology Information System, before the patient attends for his/her procedure. With the appointment confirmation the patient or ward will be sent details of the procedure together with information on preparation procedures and proscriptons.

6.21 The consultant radiologist undertaking the procedure will require access to general medical notes relating to the patient and will discuss them with the medical team caring for the patient. Prior to the interventional and some imaging procedures, the radiologist should discuss the procedure with the patient and obtain written consent. In the case of in-patients, this may be undertaken on the ward. For out-patients, a consulting room, office or other facilities to enable such a discussion should also be provided within an interventional suite or department. An X-ray viewer or computer review station should be provided in this space to enable demonstration of the problem and the intended procedure to the patient.

6.22 In-patients would have already changed into a theatre gown and will be transferred to the suite by a trolley or bed. Patients requiring some form of pre-medication will be receive this on the ward. In the majority of circumstances, only a small number of patients will require GA. In order to facilitate the

induction and recovery from anaesthesia, a combined anaesthesia/recovery area should be provided.

6.23 In the majority of circumstances, procedures will be undertaken with sedation. Local anaesthetic, pain relief and anti-nausea drugs may be given prior to the procedure. This will be done either on the ward or within the interventional radiology suite, either in a patient preparation area, or within a combined preparation/recovery room as mentioned above. Sedated patients will require monitoring of blood pressure, oxygen saturation and ECG during interventional procedures, possibly using trolley-mounted monitoring equipment. Piped oxygen and vacuum services will need to be available within the procedure room.

6.24 A small number of procedures, such as those involving children or more complex procedures, will require GA. In order to facilitate the induction and recovery from anaesthesia a combined induction and recovery area should be provided.

6.25 Because out-patients will need to change into hospital gowns, changing facilities comprising two cubicles per procedure room should be provided, in combination with local sub-waiting and refreshment facilities for relatives accompanying the patients. Alternatively, the patient may change in the curtained cubicles within the day case ward or recovery/induction area if there is insufficient space for additional cubicles. Patients admitted for day case procedures will usually:

- be given early morning admission times;
- be booked onto morning lists to leave sufficient time for patient recovery. Patients can usually go home by late afternoon;
- have uncomplicated medical histories, for example normal renal function and normal blood clotting is usually required;
- require diagnostic imaging with minor interventions and low complication rates;
- have inserted four or five French catheter systems, which will enable faster haemostasis;
- be subject to the use of arterial closure devices in some cases;
- be monitored and observed in the recovery bay and day-case ward post procedure so sedation can be used if required.

6.26 Valuables will not accompany the patient into the examination for hygiene and cleanliness reasons. Therefore lockers should be provided for the storage of belongings.

6.27 The majority of in-patients and out-patients will be transferred to the interventional radiology room by bed or trolley, possibly having received some form of sedation or other pre-medication. A number of these patients will be quite ill and unable to walk into the examination room. The patients will be transferred from the bed or trolley to the imaging table by the use of pat-slides. For heavy patients, a hoist may be appropriate.

6.28 Unlike conventional diagnostic imaging, interventional procedures may take a considerable time and the length will not always be predictable. Procedures may be as brief as 30 minutes, or as long as three hours. An average duration of one to one and a half hours may be appropriate when considering patient throughput. Preparation and recovery times will be additional.

6.29 Following the procedure, the patient can usually be transferred from the X-ray table onto a trolley or bed and then straight into an adjacent recovery room or area. This vacates the interventional room for cleaning and to be made ready for the next patient with the minimum of delay. In the case of vascular procedures the puncture site (either in an artery or vein) must be compressed for about 10 minutes, to control bleeding and reduce haematoma. After an arterial procedure, the patient must remain flat for between 4 and 6 hours to ensure the puncture site has “healed” sufficiently. Once haemostasis has been achieved, the patient can be transferred to the ward, where observations will continue for several hours.

6.30 For patients who need to be mobilised more quickly or who may have blood clotting problems several closure devices are now available. If these are used, patients can get out of bed within two to three hours. This enables cases to be undertaken on a day patient basis more easily.

LIST OF ACCOMMODATION

6.31 Accommodation in support of vascular and non-vascular interventional procedures should be as follows:

- an examination room containing the multi-angular X-ray projection fluoroscopy equipment for vascular and non-vascular procedures;
- a control area housing the computer workstations associated with the imaging equipment;
- a small area outside the examination room for storage of the lead-lined aprons and other radiation protection equipment;
- sub-waiting areas for both out-patients and, where appropriate, in-patients;
- changing cubicles for patients;

- combined anaesthetic induction recovery area, depending on the use of anaesthetics and local policies;
- a machine room, depending on equipment type and manufacturer;
- storage space for catheters, and sterile packs;
- other accommodation which maybe shared with other modalities in a larger diagnostic imaging department are described elsewhere but listed for reference purposes;
- a day case recovery ward for out-patient appointments;
- a porters' base to assist with the transfer of patients to and from the wards;
- a counselling room;
- a main reception area for patients;
- a dirty utility/disposal area;
- a clean utility;
- a laser printing facility;
- toilets for use by the patients and accompanying relatives/carers;
- scrub-up facilities.

ROOM AND EQUIPMENT DESCRIPTIONS

The examination room

6.32 All the imaging will be undertaken using an image intensifier combined with an X-ray source mounted on a movable multi-angular c-arm arrangement. Images will be viewed in real-time using examination room monitors as described earlier and fluorographic images can be acquired for clinical reporting reasons or to demonstrate the efficacy or success of an interventional procedure. A ceiling-mounted X-ray tube will not be required for use with this type of equipment.

6.33 The patients will always be lying on the patient table during the procedure. The tabletop will be powered and capable of a wide range of motorised movements including vertical, longitudinal, lateral and in some cases tilting independently. The c-arm can move in all three orthogonal planes to give a wide range of alternative imaging projections. Fluorographic and fluoroscopic exposures are usually initiated by the use of a footswitch located close to the patient table and additionally, fluorographic exposures may also be initiated by switches in the control area. Care should be taken to minimise any hazards with any trailing leads arising from these devices.

6.34 Clinical staff may remain in the examination room during the majority of the imaging or interventional procedure. However some of the personnel may retreat to the protected control area or move away from table during fluorographic exposures to minimise their personal radiation dose. For example, this may be good practice when acquiring digital subtraction angiography images with a pump injection, as the radiologist and other personnel are able to move away from the table, so reducing their personal radiation dose. This may not always be clinically feasible and may increase the overall risk to the patient from the procedure.

Types of equipment

6.35 There are two categories of equipment that can be installed to meet the clinical objectives outlined above. These categories are:

- a. both c-arm and table are cantilevered from mountings near a set of control and power and generator cabinets, which will typically be located along the longer side of examination room. In this arrangement, access to the patient table will be along one side only for health and safety reasons. The design of the unit will generally permit a wide range of vascular and interventional work and, through the use of the combined 90°-tilting table and c-arm, may also be used for barium contrast work. These units would generally not be used for cardiac applications due to the size of the image intensifier and the additional costs involved in upgrading the equipment to meet the additional imaging performance requirements.

For this category of equipment the c-arm has a full range of movement along the length of the patient table and can be moved in lateral or cranio-caudal directions. The home position is to have the image intensifier above the tabletop with the X-ray tube underneath. This relationship can be inverted in some units to mimic the function of remote units if required. Space should be provided around the patient table to allow for the movement of the c-arm in all directions, with at least 2 m of clearance space.

This equipment may be particularly appropriate for paediatric interventional, vascular and barium work, as it does not incorporate an explorator as described above for conventional and remote units. All power and control cabinets are integrated with the c-arm and table assembly and will be located within the examination room. Cable distribution maybe via ceiling voids and/or wall mounted. An example of this type of equipment is demonstrated below.

Please see [Figures 6.1 and 6.2](#);

Figure 6.1 Example of a Siemens Polystar showing how the electrical supply and computer cabinets are integrated with the main imaging unit as described in the main text. Image supplied by Siemens Medical Solutions.

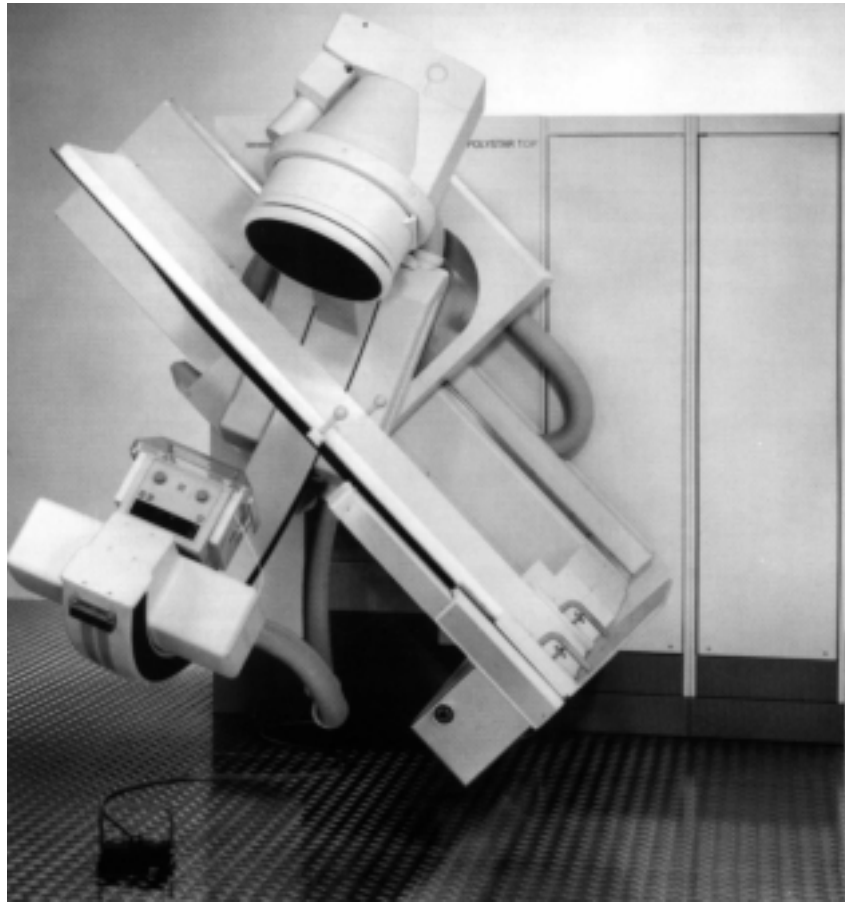

Figure 6.2 Example of an Angiostar Plus. Image supplied by Siemens Medical Solutions.



b. the patient table and c-arm are floor mounted on separate pedestals underneath these devices. The c-arm is located on to a movable floor mounted l-arm unit, which allows the c-arm to move to a number of positions around the patient table, including a parked position behind the table. This

arrangement will allow the equipment to be located centrally within the examination room with access to all sides of the equipment. Space must be allowed for the full range of movement of the equipment, particularly for those at the head of the table. The patient table for this type of equipment is often a

“floating” tabletop, with breaks for longitudinal and lateral movements. The height of the table can also be varied.

Power and control cabinets will be located away from the diagnostic equipment in a separate adjacent machine room. This arrangement may be beneficial for reasons of clinical cleanliness, and additional floor space will be gained within the examination room. The floor construction must allow for the provision of adequate cable trunking to both floor-mounted pedestals. Such cable trunking will need to be accessible for maintenance and equipment replacement. Appropriate floor constructions are described under [Engineering requirements, appendix 2](#).

This type of unit may have a slightly smaller image intensifier than the generic unit described above. The image intensifier will usually have three field sizes depending on the type of work undertaken.

6.36 The design of the unit will permit a wide range of vascular and interventional work and will not generally be suitable for procedures involving barium contrast media. This is because the table may only allow a limited tilting function. The units can be adapted to undertake rotational angiography, in which a number of 2D images are reconstructed to form 3D vascular images and cardiac angiography, provided the additional software and hardware upgrades are procured. For the latter type of procedures, a much cleaner operating environment is probably required and this is further described in [Chapter 7](#).

6.37 See [Figures 13.2](#) and [13.3](#) in Chapter 13. See [Appendix 1](#) for example plans.

General considerations

6.38 As the suite is used for interventional use, particular care must be taken with respect to the control of infection. This will influence airflow and filtration, surface finishes and ceiling construction. The advice contained within Health Building Note 26, ‘Operating departments’, and Health Technical Memorandum 2025, ‘The control of legionellae in healthcare premises’, may be of value.

6.39 For both of the above categories, the ceiling mounted equipment will include a set of integrated viewing monitors, up to a maximum of four. The monitors will require a full range of movement and will be mounted on ceiling tracks of similar design to those used to support ceiling suspended X-ray tubes, incorporating the use of articulating arms for three-dimensional movement adjustment. The monitor suspension and c-arm will be equipped with anti-collision detectors but basic design planning should

minimise collisions between these items of equipment as far as possible, whilst still allowing the radiologist an excellent view of the monitor screens, with as little glare from the artificial lighting as possible.

6.40 A small special clinical procedures lamp will be required for interventional procedures, which may be floor-standing or ceiling-mounted. Again, this should be designed not to collide with other devices.

6.41 In the majority of cases, the patient will receive sedation combined with anti-pain drugs and local anaesthesia, but in a significant minority of cases general anaesthetic (GA) will need to be administered. Space should be provided for the anaesthetist and for trolley-mounted anaesthetic and monitoring equipment. Alternatively, and depending on patient numbers requiring GA, wall-mounted, piped anaesthetic gases and AGSS should be provided, in addition to oxygen and vacuum services. The ergonomics of trailing leads should be considered, particularly as there may be a number of clinical staff in the room during a procedure.

6.42 During some procedures, particularly those involving GA there may be up to nine personnel in the examination room and control area. For example during a TIPS procedure on a patient from ITU there may be two radiologists, an anaesthetist, an ITU nurse, two radiology nurses and two radiographers present. If cardiac procedures are undertaken, then this may further increase the occupancy pressures in the examination room, as cardiac technicians should be present as well.

6.43 The contrast medium used in the majority of vascular imaging and interventional procedures is an iodine compound, in aqueous form. Shaped catheters and guide wires are introduced and manipulated into specific vessels under fluoroscopic control and the contrast media is administered either by hand or using an automated power injector, which maybe remotely operated or integrated with the function of the X-ray unit. The latter is achieved through a connection to the cabinets or control computer. The power injectors are mounted and fixed to a mobile trolley and can be moved to different locations in the examination room, depending on clinical requirements.

6.44 The contrast media are not prepared in the department and are available commercially in vials or syringes. The contrast media will be pre-warmed to body temperature by a small worktop-mounted heater (0.5 m³) unit, which maybe installed in the control or examination area.

6.45 Single-use catheters, stents and filters will be delivered to the department and will require local storage provision. Substantial numbers of different size and diameter catheters will need to be stored within the

examination room within easy access for the radiographer or nurse, for immediate use. The catheters may be stored on fixed wall racking or on specialised tall mobile trolleys specifically designed for the purpose. As an indication, approximately up to 3m linear run of wall racking may be required or a lesser area of more compact mobile storage. Longer term storage of catheters and other medical equipment associated with the clinical procedures may need to be located in an easily accessible room close to the interventional suite. This is further described below.

6.46 In addition many departments now make use of sterile packs for X-ray fluoroscopy guided interventional procedures. They are delivered to the department in boxes either weekly or monthly and, depending on the number required, will need to be stored within the department. In some cases, these packs will require substantial storage space.

6.47 Some procedures may require the use of ultrasound imaging together with fluoroscopy, necessitating the installation of a mobile ultrasound unit in this suite. One option is to integrate the power supply for this unit with the power distribution and X-ray generator cabinets. This will prevent the unit being removed from the suite, ensure that the X-ray and ultrasound units have the same electrical earth, and possibly avoid problems with trailing leads. Alternatively, another option would be to provide a single ultrasound machine to serve three or four interventional rooms in a suite to allow for better utilisation of the equipment and justify the procurement of a higher specification ultrasound unit. A further monitor may be installed to display ultrasound images only and should, where possible, be part of the main ceiling-suspended cluster or nest of monitors. This may make up one of the maximum of four ceiling-suspended monitors described above.

6.48 Facilities need to be provided for clinical hand washing and must be provided within or adjacent to the examination room. These should be in the form of a stainless two position stainless-steel scrub-up sink or trough with elbow action taps and appropriate scrub dispensers together with storage for gloves, gowns, drapes and caps. The provision of a shared "scrub-up" area may be appropriate and this could be shared between one or more X-ray fluoroscopy rooms and other modalities.

6.49 Other equipment in the examination room may include:

- a single wall-mounted triple or double X-ray film viewer;
- a mobile suction trolley for procedures where the mouth receives local anaesthetic sprays and consequently salivates heavily. This would be where a

gastroscope is moved through the upper GI tract. Piped oxygen and suction must be provided;

- trolley or wall mounted pulse-oximetry, blood pressure and ECG equipment for monitoring sedated patients, instead of the anaesthetic trolleys;
- mobile trolley or ceiling-mounted X-ray controls. This must be designed to allow them to be used in the control and examination area, if required. With trolley mounted devices, there may be a disadvantage of trailing cables. Many units are arranged so that the table and c-arm controls are mounted on a mobile trolley, which combines a radiation protection lead glass screen. This has the benefit that the radiographer works as part of the team within the room, aids communication between team members and reduces radiation dose;
- a controlled drugs cupboard for the storage of sedatives, painkillers and other drugs;
- space for general medical supplies trolleys. In addition, fixed wall- or floor-mounted cupboard storage should be provided, in conjunction with worktops to be used by nurses in preparing equipment such as catheters and other medical equipment, as required for specific procedures. As an indication, 3 m of bench space should be provided to allow the sorting and storage of catheters. Some preparation procedures may take place in an adjacent storage/lay-up space, although this is generally diminishing with the use of pre-produced sterile packs;
- local radiation protection will be required to protect staff during imaging procedures. This may take the form of lead glass ceiling suspended shields on fixed articulating arms, which are positioned close to but in front of the patient table. These are placed between the radiologist and the patient and are specifically installed for the protection of this member of staff;
- a flexible lead-lined sheet may also be fitted to the table to reduce the radiation exposure to lower extremities of staff working in the room;
- a mobile lead shield may also be located in the examination room for the protection of staff who may not be integral to the current stage of the procedure. Alternatively, a set of X-ray controls may be mounted behind a shield.
- image sequences, sound and camera views may also be relayed by CCTV for teaching purposes, or saved for the same purposes.

Imaging approach

6.50 The majority of images acquired from these units will be in a digital or soft-copy format. It is unlikely any

of the images will be acquired using conventional X-ray film, so there is no requirement to site these rooms directly near a processing area. The images may be reviewed at the main control workstation and then either laser printed and/or stored on a local or main department digital archive. There may be a requirement to network a dry/wet laser printer, which maybe shared with other modalities. In some instances, a dry laser imager maybe sited directly within the control area. In vascular imaging, the volume of images may be relatively large to demonstrate the stenosis or other clinical significant findings. In interventional procedures the number of retained images will be lower, as there is only a requirement to demonstrate the efficacy and success or otherwise of the interventional procedure.

6.51 Where rotational vascular imaging is undertaken, the images would be reviewed and then sent to a dedicated or multi-modality workstation for 3D reconstruction. This workstation could be located in an adjacent control area or in another, not necessarily adjacent, room serving a number of fluoroscopy systems or other digital modalities.

6.52 Fluorographic images may be acquired directly to a video recorder as part of the procedure. This will be located in the control area described below. With the introduction of digital acquisition techniques this practice is beginning to diminish considerably.

Control/review area

6.53 The majority of the procedures will take place with the radiographer, radiologist and other clinical staff in the main procedure . A separate adjacent control area will still be required for:

- a. the installation of a separate set of duplicate X-ray unit controls to operate the system, in case of failure of the examination room control units;
- b. review of the images acquired at the end or during a procedure and then for creation of hard or digital copies;
- c. accommodation of visiting clinicians, students and other staff to observe the procedure;
- d. a second radiographer who, if present, may remain in this room during the procedure.

6.54 The control area access should have direct access from the examination room and should be provided with a large lead glass observation window.

6.55 Project teams should consider two different options for the provision of a control area associated with a non-vascular and vascular interventional procedure room:

- a. the control/review area may be designed in similar manner to general X-ray rooms by the provision of radiation proof screens. The control area will take up part of the procedure room. The area will need to be larger than general X-ray rooms because of additional equipment and members of staff present. This may be appropriate where there are limitations on the space available.

This area should have separate access to a corridor. A radiation proof door may need to be provided between the corridor. This will depend on the shielding and attenuation provided by the screens;

- b. a separate room may be provided for the installation of the control equipment and imaging workstation. Direct access and observation of the examination room must be provided. This area may be used as the control room for more than one interventional/ imaging fluoroscopy room. This may have advantages in terms of space saving. In this case, it may be easier to justify the provision of local dry laser printer and/or image reconstruction/post processing computer workstation serving both fluoroscopy rooms. In a DGH the conventional/remote room may share a control area with an interventional suite allowing for future adaptation of a conventional room to CT for example.

6.56 A separate computer workstation may need to be incorporated in this area for the recording of patient details. In some instances, this may be integrated with the function of the imaging workstation by the use of a suitable interface.

6.57 A local archive maybe located in this area to store patients' images and will be associated either with the imaging workstation or with the post-processing computer. This archive may store up to two months' worth of images before they are transferred to CD-ROM, MOD or another more central digital archive. If hard-copy films are produced through laser printing with no other form of permanent copy available, they will need to be stored in a film library.

6.58 As some of the procedures may be considered by clinicians to be operations, a written record may need to be kept in the form of a session book which will be retained in the control/review area.

Anaesthetic and post-procedure recovery combined area

6.59 Recovery/anaesthesia combined areas should be provided on the approximate ratio of two bays per procedure or examination room for those patients requiring recovery or inducement of anaesthesia. The suite may be also be used for the administration of sedatives or other pre-medication prior to a procedure.

The area may be a separate room or an open plan area close to the interventional suite, provided layouts and design allow patient privacy to be maintained. In open plan designs this may take on the appearance of an acute medical 6-bed ward bay.

6.60 Each bay should be provided with standard bed head services, including power points, piped oxygen and vacuum. Some, if not all, bays will require piped anaesthetic facilities, depending on local clinical practice and protocols, for example the number of clinical procedures undertaken requiring GA, and administration of GA in the procedure room. Space will be needed for the provision of physiological monitoring devices, which may be located either on trolleys or on fixed bed-head shelving. Each bay requires cubicle curtains for patient privacy.

6.61 A free-standing desk or fixed worktop, with associated chair and under-top storage, is needed as a workbase, primarily for nursing staff in the recovery area. Some shelving and a pin-board are needed nearby, together with a controlled drugs cupboard for holding of sedatives and painkillers. In addition, the workbases will require a worktop with inset sink, associated under-bench and wall cupboards, for storage of linen and IV fluids. Resuscitation equipment will also be located within this area. A clinical wash-hand basin is needed, with associated dispensers. Approximately one nurses' workbase should be provided for two, up to a maximum of six recovery/ anaesthetic bays. The workbases should be sized according to the number of associated bays.

6.62 A combined anaesthetic/recovery area, comprising 5 bays with an associated work-base and its associated relationship with the X-ray fluoroscopy interventional room is described in the example plans in Appendix 1.

6.63 The anaesthetic/recovery area may be planned to serve adjacent modalities such as CT or MRI scanners, which may also involve the use of GA or sedation. In this case, additional recovery bays may be required.

Separate anaesthetic and recovery areas

6.64 In some instances the amount of space available, local clinical practices and number of patients requiring GA may allow for separate anaesthetic and recovery areas. The separate anaesthetic room should be located directly adjacent to the interventional suite in a relationship similar to that observed in a standard operating theatre design, to allow for easy transfer of the patient into the procedure room. The room will be similarly equipped and sized to those used in the operating theatre environment. Health Building Note 26 and Health Technical Memorandum 2025 give further details of this.

6.65 In this instance, the recovery area will probably be used solely for this purpose and therefore piped anaesthetic services should not be provided. The recovery area may be used for both in-patients before they are transferred to the ward or patients admitted on a day case basis. A nurses' workbase also will be required.

Sterile store and preparation area

6.66 As stated above, a number of the clinical packs used in the procedures may be delivered to the department prepared. However, there are still some instances where assisting nurses will need to prepare some packs prior to a procedure. Sterile storage areas should therefore be allocated within the suite or department for catheters, guide wires prepared packs and other clinical items are used during clinical procedures. In addition, space should be provided to allow staff to make up additional procedure packs as and when required. The storage and preparation areas should be sterile environments and should meet standards in design indicated Engineering requirements, [Appendix 2](#).

Dirty utility store

6.67 Space should be provided for the disposal of clinical and non-clinical rubbish and dirty linen skips, which should be emptied regularly. The store should be located outside the procedure, recovery/anaesthetic and control areas and may form a separate room shared with other modalities.

Staff changing facilities

6.68 Separate changing facilities should be provided for male and female staff within the diagnostic imaging department to allow for a minimum of six personnel working in the interventional suite. Separate male/female shower facilities will be needed for these members of staff and additional space should be provided for four additional members of staff from outside the department attending discrete procedures. Further general design notes on staff changing areas are described in Auxiliary accommodation, [Chapter 15](#). Each member of staff will require his/her own separate locker.

ASSOCIATED SPECIALISED ENGINEERING REQUIREMENTS

6.69 Please refer to Engineering requirements, [Appendix 2](#).

MOBILE FLUOROSCOPY EQUIPMENT AND THE REQUIREMENTS FOR OPERATING THEATRES AND OTHER ENVIRONMENTS – SPECIAL CASE

6.70 An illustration of mobile fluoroscopy equipment is shown below (Figure 6.3). As is evident, the device is made up of a trolley mounted, mobile, c-arm fluoroscopy-imaging device with integrated X-ray control panel and separate trolley mounted single or double image viewing monitors. Usually, these devices are coupled with a single high-tension electrical cable and powered using a standard single-phase 13A electrical socket. These units of X-ray equipment may have the following clinical uses or be utilised in the following locations:

- a. in orthopaedic surgery for checking the positions of metal pins, etc. during surgery;
- b. gastroendoscopy suites for undertaking ERCPs where these are not undertaken in the main diagnostic imaging department;
- c. temporary cardiac pacing procedures in cardiac resuscitation wards.



Figure 6.3 Main components of a mobile image intensifier. Image supplied by Siemens Medical Solutions.

6.71 The use of mobile fluoroscopy procedures requires the use of radiation shielded or protected areas. The use of hollow breezeblocks in the construction of the walls may not be appropriate and the provision of single density brickwork or lead ply may be required. The level of radiation protection construction required will depend greatly on the use of the equipment and consultation with the RPA in this area is advised. X-ray mobile fluoroscopy equipment will probably be used only in designated areas and as such it may be possible to designate a separate electrical socket for use with the equipment. This is to ensure the protection of the fluoroscopy equipment from electrical supply anomalies and that energy put into the earth by the X-ray unit does not damage other items of electrical equipment. This is further described in [Engineering requirements, Appendix 2](#).

6.72 Staff working with the equipment should be provided with lead-lined jackets and possibly mobile radiation protection shields for their protection during X-ray imaging procedures.

6.73 Unlike general mobile X-ray equipment, it will not be possible to test or undertake maintenance on mobile fluoroscopy equipment in a non-radiation protected area, as the radiation exposures during testing are much higher. For this reason, a separate radiation protected room should be provided within the diagnostic imaging department for the testing and maintenance of the equipment. The same room can be used to test general mobile X-ray equipment. Alternatively, a shielded X-ray room could be used for testing the equipment, although this may affect patient throughput.

7 Specialised angiographic systems for cardiac applications

BACKGROUND AND INTRODUCTION

7.1 The requirement for cardiac imaging services, particularly cardiac angiography, interventional cardiac radiology and radionuclide imaging, is recognised as important in the delivery of National Service Framework standards for coronary heart disease, which applies almost exclusively to adult patients.

7.2 It should be noted that the majority of these installations will be incorporated into services at the tertiary level, particularly where they are used in conjunction with paediatric patients. The clinical requirement may be to support a nearby/integrated cardiology unit or to support cardiac services as whole within a tertiary referral hospital. Installing these units in specialist institutions may ensure that they are fully utilised by highly trained cardiologists (imaging radiologists who specialise in cardiac disease), who are able to maintain their expertise in what is a fast developing area of medicine.

7.3 This chapter provides guidance on the planning and design of fluoroscopic/fluorographic imaging and interventional facilities for the diagnosis, treatment and care of patients suffering from heart disease. Facilities will be described to diagnose and treat adult patients but special considerations for paediatric patients will also be noted. The facilities are similar to those described in [Chapter 6](#) on vascular and non-vascular X-ray imaging, but the equipment is on the whole much more technically capable, usually has a smaller image intensifier and can image at much higher fluorographic imaging rates.

7.4 In some instances, it may be clinically necessary, particularly with children, to provide imaging in two perpendicular planes, almost simultaneously, and this is achieved by the use of two image intensifiers and X-ray tubes mounted on two separate c-arms within the same examination room. This configuration is shown in [Figure 7.1](#).

7.5 One manufacturer has started to provide a system fitted with a solid state detector instead of a more conventional image intensifier unit. Other equipment manufacturers are in the process of preparing similar units for full commercialisation. It is expected that, due to their potentially superior imaging performance in

cardiac imaging, these units will supersede more conventional image intensifier units over the next five to ten years. The potential impact on the built environment of these types of systems is also discussed below, although it should be noted that only one to two of these units are currently installed in UK hospitals.

CLINICAL AND OPERATIONAL OBJECTIVES – ADULTS

X-ray coronary angiography

7.6 X-ray coronary angiography is used in demonstrating coronary artery disease and in diagnosing and planning coronary artery bypass grafts (CABG) where it is considered that the patient may benefit and will tolerate the procedure.

7.7 It is a technique that involves imaging the coronary arteries of the heart to look for stenoses or artery narrowing including blockages. It is usually connected with patients suffering from angina and other heart related problems. In this clinical procedure, the contrast medium is injected directly into the branch of the aorta, which supplies the three coronary arteries. This is achieved by the use of a slim sterile flexible tube – cardiac catheter, which is inserted into the patient and manipulated from the femoral artery. High frame rate (25 frames or more per second) images are acquired digitally as the contrast media moves through the coronary arteries. The images are then reviewed and reported later, using an associated clinical workstation.

7.8 High temporal resolution, i.e. imaging at high frame rates, is a requirement for this diagnostic examination. This one of the major differences between this type of equipment and that supplied for vascular and non-vascular interventional radiology. As such, this may require the installation of additional equipment or plant to facilitate this clinical requirement.

7.9 X-ray coronary angiography is still one of the principal diagnostic tools of cardiology, and has an important role to play in a number of cardiac diseases. For this reason facilities for undertaking cardiac angiography are often provided as an integral part or in support of cardiology treatment facilities.

Percutaneous Transluminal Coronary Angiography (PCTA)

7.10 Angioplasty is a non-invasive procedure whereby the repair or reconstruction of narrowed or completely obstructed arteries, resulting from a degeneration of the walls of the arteries due to the formation of fatty plaques and scar tissue, is undertaken without need for thoracotomy. In PTCA – “balloon angioplasty” – an inflatable balloon, mounted on the tip of a flexible catheter, is placed within the lumen (cavity) of the affected artery, at the site of the disease, under X-ray control. For a description of catheter placement, see the X-ray coronary angiography section, [paragraphs 7.6 to 7.9](#). On inflation of the balloon, the lumen is enlarged, disrupting the inner wall of the artery, which reduces the chance of further narrowing occurring. The site of the obstruction is identified by coronary angiography and PCTA may be undertaken as part of the same procedure.

7.11 Other procedures undertaken in this suite may include the implantation of pacemakers and ICDs or direct electrophysiology measurement under fluoroscopy control.

PATIENT JOURNEY – ADULTS

7.12 Patients who have already undergone a heart attack or are suffering from chest pains may be admitted through the A&E department where they are stabilised, have multi-channel ECG investigation and, if indicated, are administered with “clot busting” drugs such as streptokinase. This would be undertaken prior to transfer to coronary care unit, cardiothoracic operating theatres, or wards. The patient may be investigated using coronary angiography examinations and in some cases undergo PCTA, if this is considered of clinical benefit to the patient. The diagnostic imaging and interventional procedures will usually be undertaken in a tertiary referral centre. Where patients attend A&E in a tertiary centre, then this may allow the possibility of coronary angiography or PCTA relatively soon after the heart attacks.

7.13 Alternatively, patients with transient but frequent chest pains may be referred to a cardiac specialist, who may refer them for coronary angiography. The results and outcome of this examination may determine the next step for the patient to be a coronary artery bypass graft or PCTA, which may be undertaken at the same time as the coronary angiography examination. In this case, patients for coronary angiography examinations may attend as in-patients and will be admitted to hospital either the day of or the day before their procedure and then allowed at least one to two days to recover before going home. In some instances, the patient may be admitted as a day case patient.

7.14 Patients may be transferred from secondary healthcare centres for coronary angiography examinations or in some cases PCTA. The results of the coronary angiography examination may be used to plan surgical interventions, which again will be undertaken at the tertiary referral centre.

7.15 Generally, adult patients can be successfully examined or undergo PCTA procedures using single plane fluoroscopy equipment and there may be no requirement to procure bi-plane systems. As a general guide, imaging examinations and interventional procedures may take between 30 minutes and up to two to three hours for complex PCTA cases.

PATIENT JOURNEY – PAEDIATRICS

7.16 In the majority of cases, heart problems in paediatric patients will be of a congenital nature and will usually be picked up during the child’s early years. Virtually all will be referred to a tertiary referral centre for diagnosis and treatment, as care of these patients requires specialist equipment and expertise. Generally, children will be referred to the tertiary centre either from a consultant at secondary care, A&E departments or a GP working in a primary care setting. Diagnostic procedures using X-ray fluoroscopy/fluorography equipment of this type in paediatric patients are avoided unless contra-indicated, as the radiation doses from the procedures can be quite high. They have been largely replaced with the use of ultrasound. However, interventional procedures are still undertaken using the equipment. There is the possibility that very young children may undergo these procedures and this may include neonates. The contrast media used in these procedures may induce a toxic shock in these patients, making it necessary to minimise its use. It may therefore be necessary to image paediatric patients simultaneously by the use of bi-plane equipment in two perpendicular planes, to reduce the amount of contrast media required to complete the procedure.

LIST OF ACCOMMODATION FOR TERTIARY CENTRE PROVISION

7.17 The list or schedule of accommodation to provide cardiac angiography services in a single suite should be as follows:

- a cardiac X-ray fluoroscopy/fluorography procedures room. In a tertiary referral centre, there may be many of these rooms containing a mixture of biplane and single plane X-ray imaging equipment. These are sometimes referred to as cardiac catheterisation laboratories or cat labs;
- a control area to house the main computer workstation controlling the X-ray equipment;

- a technical room for housing all the electronics equipment;
- a separate dedicated anaesthetic room located directly adjacent to the procedures room;
- a small area outside the room for the storage of lead-lined aprons;
- scrub-up facilities.

7.18 The following accommodation could be provided to support a number of cardiac catheterisation laboratories:

- a sub-waiting area, including an area where patients relatives are able to wait comfortably during long procedures;
- a day case ward. This area should allow for patients to wait who may have been transferred from the ward. In some instances it may be possible to share this space with other modalities;
- a separate recovery area;
- a porters' base to assist with the transfer of patients to and from the wards;
- a counselling room;
- a dirty utility/disposal area;
- a clean utility;
- toilets for use by the patients and accompanying relatives/carers.

ROOM AND EQUIPMENT DESCRIPTIONS

Examination room

7.19 The design and character of the cardiac catheterisation suite will be similar to that used for non-vascular and vascular interventional work. All catheter laboratories should be fitted to operating theatre standard.

7.20 The number of cardiac catheterisation laboratory suites required will depend on the patient throughput and the number of hospitals served by the tertiary referral centre. Each suite should be capable of undertaking a series of procedures. If paediatric patients are to be cared for, a minimum of one of these laboratories should be equipped with bi-planar digital angiography machines, and at least one laboratory should be equipped with single plane angiography equipment. Each laboratory will require a ceiling-mounted and optionally moveable pendant for anaesthetic services and a ceiling-mounted investigation lamp. Medical services will be provided from ceiling- or wall-mounted outlets and will comprise medical oxygen,

nitrous oxide, compressed air at 7 bar and 4 bar pressure and suction. Alternatively, a pendant solution to medical gases provision may be preferred. Anaesthetic gas scavenging will also be provided. Environmental services, finishes and fittings to all laboratories will be to minor operating theatre standard.

7.21 The laboratory, in the majority of cases, should be made large enough to accommodate bi-plane equipment, even if single plane equipment units are to be installed. The function of the room may alter at a later date due to changes in clinical practice. Biplane units will be larger to accommodate the additional c-arm and because of the additional numbers of persons present at some of the procedures carried out in these laboratories. This will relate to a minimum size of approximately 50 m² actual room space and dimensions of approximately 7.5 m. x 6.75 m. The room should be planned to accommodate a minimum of six, up to a maximum of 11 members of staff and students plus the patient. The major items of equipment are listed below. Designers should be aware that critical area and dimensions can vary according to the needs of a variety of operational and equipment options and it is therefore important to obtain information on client preferences and the selected manufacturer's equipment before designing the room in detail:

- multi-angular isocentric X-ray digital single or bi-planar angiographic system. Most single plane units currently available are floor-mounted, but ceiling-mounted systems are available. The installation will commonly incorporate a ceiling-suspended transparent leaded panel to give an element of radiological protection while allowing the cardiologist an acceptable view of the patient. Some manufacturers offer a combination of floor mounted equipment with ceiling-mounted c-arm and/or couch assemblies. Where ceiling mounted or composite systems are to be installed, some additional reinforcement of supporting structures may be required. This is normally in the form of unistrut. Floor-mounted sub-components of the system are normally bolted through the floor structure or are otherwise securely fixed to it by rag bolts or other secure heavy duty fixing devices, capable of retaining a moving mass weighing up to three metric tons with high residual torque;
- integrated or closely associated variable height patient couch, capable of multi-directional movement and operating in conjunction with an isocentre positioned at or near the patient's heart. Exceptionally, tilting along the patient's long axis may be required, and local discussion of this issue is advised;

- two to four ceiling-mounted monitors displaying real-time and digitally recorded angiographic images, with optional additional monitors displaying physiological data. There is a move to flat panel display, which will have the effect of reducing suspension and other engineering requirements. It should be noted that very occasionally trolley mounted monitors are encountered, and that although these have now been almost universally superseded by the ceiling-mounted versions, they may have something to offer in the resolution of the couch to control room relationship issues discussed later in this chapter;
- power injection facilities for contrast media. These are usually trolley mounted, but there is also a ceiling suspension option available;
- anaesthetic trolley and resuscitation equipment;
- minor procedures trolley;
- worktop with wall-mounted cupboard over and under (open shelves should not be used for hygiene reasons), wall- or bench-mounted warming cabinet for preparation of contrast media, wall-mounted drugs cupboard and double X-ray viewer, wall-mounted or floor-standing catheter rack;
- a lead-lined apron rack, located at the entrance to the room, preferably outside the controlled area (see below). The weight of such racks is considerable and may require additional reinforcement to supporting floor structure. Storage for lead glasses and thyroid shields should also be considered but this maybe in the main examination room for security reasons.

7.22 At least one bi-planar laboratory should be designed to undertake electrophysiological studies. This should be large enough to accommodate necessary equipment and a minimum of eight team members plus the patient. The main space consuming items of equipment that are additional to the normal requirement are:

- two additional overhead monitors;
- a desk-mounted physiological monitoring system and display. There is a strong clinical preference for these to be located in the laboratory although other – mainly radiation safety – considerations would suggest the adjacent control room to be a safer location. The problem is to combine the safety benefits of a screened environment with the clinical requirement for immediate contact between those undertaking and those monitoring the procedure. To date this problem has not been solved satisfactorily, but mounting the desk on a trolley may provide a solution.

7.23 A number of hospitals are beginning to use ultrasound during the procedures, particularly those involving paediatrics, as means of supplementing and replacing some the X-ray imaging. Space should be provided in the examination room for the ultrasound unit, an additional operator and monitor to display the images. The power supply for the ultrasound unit may, depending upon operational requirements, be integrated with that of the X-ray system.

7.24 Each laboratory will be served by an X-ray system control area, which conventionally is provided ensuite, but in a separate compartment. It will be radiation protected and have good visual and voice contact with the cardiac catheterisation laboratory. This arrangement is usually preferred on ergonomic and safety grounds. Exceptionally, and according to client choice, the cardiac catheterisation laboratory room is open plan with no separate control area, with all persons present wearing radiation protection clothing.

7.25 According to client choice, control areas may be provided separately for each laboratory, or shared between pairs of laboratories. In the latter case, the area must be large enough to enable two teams with their monitoring equipment to operate independently and maintain unimpeded access to the laboratory served. Space must also be available for surgeons and visiting specialists to observe procedures in a radiologically safe environment.

7.26 A problem that equipment manufacturers and facilities designers have not yet overcome is the positional relationship of the patient couch to the procedure viewing panel in the control room. It arises from what are potentially conflicting requirements for access to and observation of the patient by the different members of the team – some of whom are stationed in the control room – who are, under present regulations jointly responsible for the safety of the patient while the examination is being undertaken. This conflict is normally resolved by acceptance of an element of compromise, but the challenge of developing a solution that is entirely satisfactory on all relevant counts remains. The main issues and constraints that need to be addressed, largely centering around or impacting upon the orientation of the patient couch, are:

- the need for the cardiologist, who may stand on the left or right of the couch depending on whether s/he is left or right handed, to have a clear and unobstructed view of in-room ceiling or trolley mounted monitors. From the point of view of the operator, an arrangement whereby the couch is at right angles to the control room viewing window, thus presenting an identical view of the patient along the long (cranial-cordal) axis of the body would seem the

best option, since it is not affected by the side on which the cardiologist stands;

- the need for observers outside the control room to have a clear view of the patient in order to discharge the duty of care referred to above. It is argued that this cannot be properly done if only the feet of the patient are visible, as would be the case if the couch were placed at right angles to the control room. An arrangement whereby the couch is placed parallel to the control room viewing window, with the in-room team located on its far side would facilitate better observation, but would significantly disadvantage a left handed cardiologist, who would prefer to stand on the near side of the couch;
- the need for an arrangement that allows sound patient care to be undertaken in an area that is dominated by large items of equipment, some of which move during the course of the examination/ procedure. This includes direct monitoring of the patient by a nurse stationed near the patient's head, and easy transfer of the patient on and off the examination couch;
- the need for an arrangement that works effectively within the engineering and other physical constraints imposed by the design of the equipment and the possible conflict between the operating space requirements of the large number of moveable ceiling- and floor-mounted items of equipment that are located in these rooms.

Accommodation to support the examination room

7.28 Additional requirements may include:

- additional clinical space adjacent to the laboratory. Separate anaesthetic rooms and/or exit recovery bays may be required. There is an increasing tendency to treat angiography facilities as operating theatre suites. This will impact upon their layout as well as increasing the scale and complexity of the facility;
- a combined preparation room/CSSD store for each laboratory, although these may be shared as appropriate (refer to HBN 26 – 'Operating department');
- scrub-up and sterile gowning areas for each laboratory, located in an adjacent communicating space – the scrub-up area may be provided within the laboratory;
- accommodation for dedicated X-ray imaging generator and imaging computer equipment serving each laboratory. The preferred location for this equipment is an adjacent room or area accessed from within the laboratory by sound attenuating,

radiation protected doors, or (preferably) removable panels. The presence of high-tension electricity, and the need for radiation protection for persons working in the room when the communicating door to the machine room from the laboratory is open, should be noted. Access to this room from outside the laboratory is positively discouraged on safety and maintenance efficiency grounds;

- facilities for the safe storage of used surgical instruments and trolleys used in the angiography laboratory, prior to dispatch to a central facility for bio-decontamination and re-processing. Trolley storage for more than a single session of, say, five to six procedures is not required. Local sterilizing of used instruments is strongly discouraged;
- a preparation/recovery area for approximately three pre- and six post-procedure patients, depending on the projected throughput of the laboratories. Medical services, comprising oxygen, compressed air and suction, will be provided at each bed head from wall mounted outlets. Anaesthetic gas scavenging must also be provided. The layout of the facilities should allow good bed access and patient monitoring;
- a nurses' base, together with clean utility and dirty utility rooms will be associated with the preparation/ recovery area. Controlled drug storage must also be provided;
- a WC must be provided immediately adjacent to the preparation/recovery area;
- staff changing facilities with showers/WCs within the department;
- laser imager printing area, accommodating laser imager and processor and film storage. Increasingly, modern laser printers use a dry process and do not require a docked wet film processor. Some centres do not use hard copy and may instead employ electronic image network communication, viewing and archive storage, and will often transfer images using CD-ROM. Electronic imaging will require a suitable computer room and associated facilities which may supplement or replace laser imaging;
- image archive workstation, review room and image archive storage. The review room should accommodate approximately four workstations and about eight staff, and the image archive store should accommodate about 50,000 CDs if each CD holds a single patient record. The actual number of CDs will depend on overall patient throughput and a number of other factors, including the rate at which images are acquired during the examinations.

It should be noted that cine-film imaging in cardiology is now virtually obsolete, but legacy film reading using

a self-contained projector will still be necessary in most centres. Space may still need to be identified for the storage of these films which may need to be stored up to 50 years or longer in teaching centres;

- central departmental store and linen store. A central bay must also be provided for storage of lead protective devices, including lead rubber aprons, lead glasses, thyroid protectors and dosimeters. Because some of these items are very heavy, local reinforcement to supporting structures may be necessary. Storage of these items within the laboratory is discouraged, since it implies that unprotected persons will have to enter the room to obtain them, which might be hazardous or disruptive;
- simple local catering facilities;
- two cleaner's rooms, one for general use, one for laboratories.

Operational policies

7.29 All staff working in clinical areas and visitors will wear appropriate theatre clothing, and facilities for the storage of these garments must be provided and conveniently located. The use of remotely located central changing facilities for this function is not recommended.

7.30 All staff working in the cardiac catheterisation laboratory will follow a clearly defined changing sequence and route into the laboratory.

7.31 This sequence will determine the staff route into the cardiac catheterisation laboratory and, therefore, the positional relationship between the physical spaces needed to accommodate it, that is, general access zone corridor; changing room; restricted access zone corridor lead apron local storage (outside or adjacent to the entrance to the cardiac catheterisation laboratory) through to the laboratory.

7.32 In the case of those who need to be scrubbed up and gowned for the procedure, the sequence is modified appropriately to include the scrubbing and gowning activities, although this may have little effect on the overall design.

Functional relationships

7.33 The location of catheterisation laboratories close to – ideally contiguous with and directly connected to – cardiothoracic operating theatres is increasingly seen as an essential measure to advance patient safety in the event that surgical intervention become necessary. In addition, the laboratories must be close to and have simple and direct access to:

- cardiac day case unit;
- coronary care unit;
- intensive and progressive care units.

7.34 All of these close relationships are supported for reasons of patient safety.



Figure 7.1 Example of a floor-mounted Cardiac Angiography unit. Image supplied by Siemens Medical Solutions.

7.35 There must be good and direct access to and from:

- the centre/hospital main entrance;
- Accident & Emergency department or ambulance drop-off point;

- cardiology and cardiothoracic in-patient accommodation.

*Figure 7.2 Example of a cardiac X-ray biplane imaging system.
Image supplied by IGE Medical Systems.*

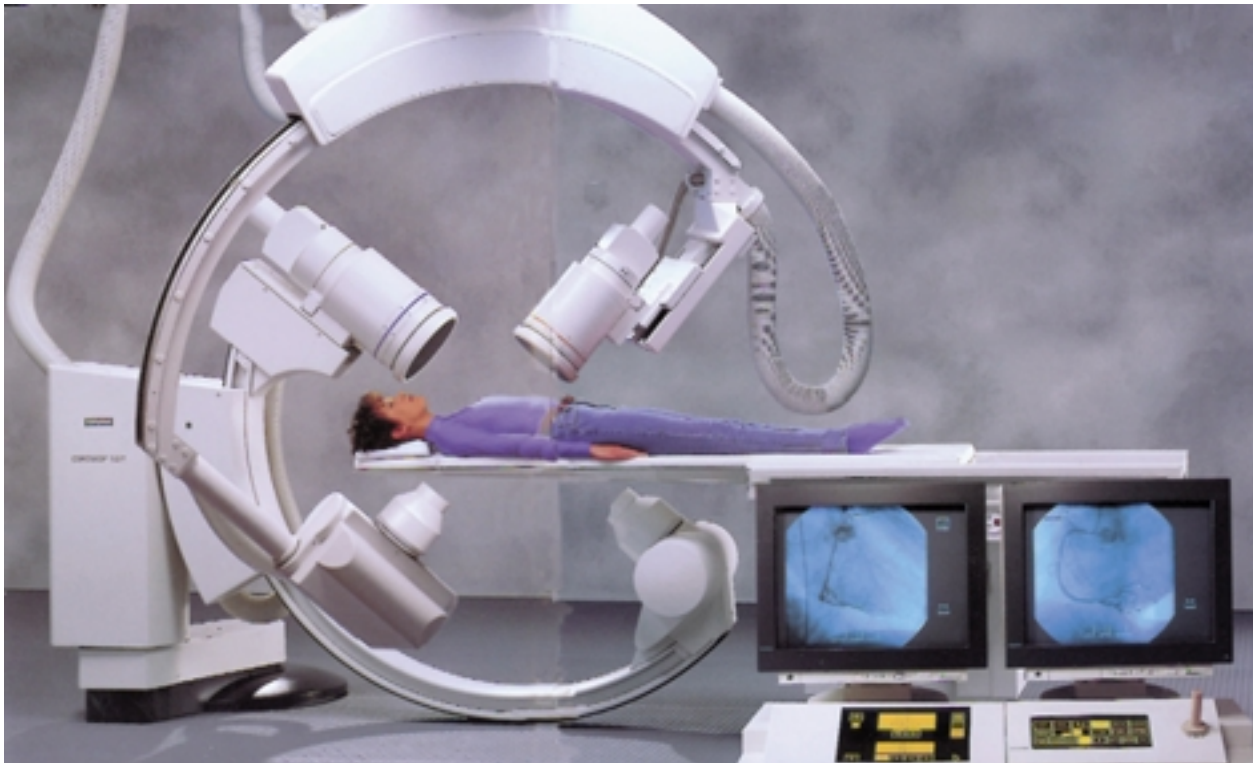

*Figure 7.3 Powered contrast media injector used in cardiac angiography and other imaging procedures.
Image supplied by Siemens Medical Solutions.*



8 Radionuclide imaging facilities based on gamma (Anger) camera systems

BACKGROUND AND INTRODUCTION

8.1 Radionuclide imaging, or nuclear medicine, utilises radiopharmaceuticals or unsealed radioactive. A pharmaceutical compound is labelled with a radioactive isotope and administered to the patient. A device known as a gamma camera then images the distribution of the radiopharmaceutical within the patient, at a suitable time following administration.

8.2 The radioactive isotope used in the majority of radionuclide imaging investigations is Technetium 99m. The pharmaceutical compound used depends on the anatomical area of interest. The main advantage of radionuclide imaging over other techniques such as CT and MRI is that physiological as well as anatomical information may be derived from the images acquired.

8.3 The reasons that Technetium is widely used are as follows: a short half-life of only 6 hours; low toxicity; appropriate energy for detection; it is relatively easy to prepare and only slightly alters the biological or chemical properties of the pharmaceutical compounds and that it emits gamma radiation only.

8.4 Aspects of preparation handling, radiation protection and delivery are detailed throughout this chapter and relate primarily to the use of Technetium 99m for diagnostic purposes only. The therapeutic uses of unsealed sources are described elsewhere, but healthcare planners should be aware that therapeutic administration of unsealed sources may be undertaken in the same department. Please also refer to the new NHS Estates guidance on cancer services.

8.5 Radiopharmaceuticals are usually administered to the patient intravenously and sometimes by other means such as inhalation or orally. As stated above, a gamma camera (see Figure 8.1) is used to detect the resulting distribution of the radiopharmaceutical within the patient's body. Hot or cold areas on the resulting image may relate to clinically significant findings. The essential detecting component of a gamma camera is a scintillation crystal. The environment in which a gamma camera is installed must remain relatively stable and this is further described in Radionuclide imaging, Chapter 8.

8.6 A few centres have procured multi-detector gamma cameras and are making use of their special capabilities to undertake Positron Emission Tomography (PET)



Figure 8.1 Example of a single detector gamma camera and its movement during SPECT acquisitions. Image supplied by ADAC Medical Systems.

Figure 8.2 Example of a dual detector gamma camera. Image supplied by Siemens Medical Solutions.



scanning. Radionuclides of higher energies but shorter half-life are used. This has implications for the facility design and environmental considerations. Some comments on this are made in this chapter, but the reader should also refer to [Chapter 9, PET](#) for additional details.

CLINICAL AND OPERATIONAL OBJECTIVES

Introduction

8.7 A wide range of different organs may be investigated using radionuclide imaging, such as the brain, kidneys, lungs, liver, heart and bones. However, emerging areas where radionuclide imaging may be the modality of choice for a broad range of suspected pathologies are: static bone imaging; quantitative and qualitative renal investigations; infection imaging by the labelling of white blood cells; the staging and diagnosis of cancer. Therefore, a radionuclide imaging suite may form an integral part of a cancer unit or a cardiac and respiratory imaging facility.

8.8 Except in specialist children's centres, the majority of patients being imaged will be aged above 50 and in some cases extremely ill. Space should be provided for dedicated resuscitation equipment within the radionuclide imaging suite in an area that it will not be damaged and has a relatively low risk of being contaminated.

Cardiac function tests

8.9 Cardiac function tests include stress/rest tests where the patient is imaged at rest, then undergoes exercise and is imaged again. The purpose of this test is to look for heart disease and possibly differentiate

between ischaemic heart problems and myocardial infarction. The stress part of this test can be performed by pharmacologically stressing the patient or by using devices such as small treadmills or exercise bicycles to stress the patient. If the patient is stressed pharmacologically, then additional staff may be present during the procedure and will increase the occupancy pressures in the main examination room. The type of procedure employed will have a direct effect on the design of the facility, with the approach used depending on clinical policies at the hospital or trust.

8.10 Particularly in specialist cardiac centres, consideration should be given to providing a separate stress room to support cardiac imaging procedures. The design of the room is briefly described later in this chapter.

Diagnosis of infection

8.11 The diagnosis of infection by the use of Technetium labelled white cells is relatively common in a number of radionuclide imaging departments. There are no special requirements in respect of the actual examination room, but separate preparation facilities need to be provided for labelling the white cells. These facilities are described under [Radiopharmacy](#) in Chapter 8, Radionuclide imaging facilities.

Renal examinations

8.12 A full range of renal examinations may be undertaken. Examples include micturating cystograms in young children to look for renal Reflux, and measuring Glomerular Filtration Rates (GFR) in adults. Some tests require the patient to micturate while being scanned either sitting or standing. The room should be equipped

with mobile curtain-type screens for patient privacy, and a commode or other vessel. The environment should be designed to be sympathetic to this aim.

Head scanning

8.13 This is now being replaced by MRI and CT to a certain degree, but the use of a radioisotope species Thallium-201 and Technetium labelled pharmaceuticals for head scanning can be justified clinically in some circumstances. The use of Technetium labelled agents is more common than Thallium-201 scans.

Lung scanning

8.14 Patients, who may be in or out-patients, with suspected pulmonary embolism may have a ventilation/perfusion (VQ) scan in succession to other diagnostic investigations. In the perfusion scan, the patient will be administered with a small dose of radiopharmaceutical intravenously. In the second part of the examination, which may take at least three to six hours, a ventilation test may be conducted, depending on clinical evidence available. Ventilation scanning can be performed using Technetium labelled aerosols or a radioactive gas such as Krypton-81^m and this will have an effect on the room ventilation requirements. In some centres, the ventilation scan may be undertaken before the perfusion imaging. Where Krypton-81^m is used, perfusion and ventilation scans may be almost simultaneous.

Bone scanning

8.15 Bone scanning may be used to look for metastases secondary to a primary tumour and located in other areas of the body, for example. Since radioactive doses employed in such scans are relatively high, precautions may be required between the time patients are administered radioactive substances and when imaging is undertaken. This may relate to how near they can stand to relatives and children in waiting areas. This is given as an example and may not only apply for patients undergoing a bone scan, but also for patients receiving high doses of radioactive substances for other types of examinations. Such precautions are necessary for compliance with the Administration of Radioactive Substances Committee (ARSAC) Guidance.

LIST OF ACCOMMODATION AND LOCATION OF RADIONUCLIDE IMAGING FACILITIES

8.16 See the plans in [Appendix 1](#).

8.17 It is advantageous if the radionuclide imaging facility is provided within or close to a larger diagnostic imaging department, but in some instances floor loading and radiation protection requirements may be the overriding factor. This should be carefully discussed with radiographers, medical physicists, and an appropriately qualified and licensed consultant radiologist, who may staff and work in the radionuclide imaging facility.

8.18 To minimise radiation hazards to potentially vulnerable groups, close proximity should be avoided between the radionuclide imaging suite and the following facilities:

- a. dental X-ray rooms and other modalities, such as MRI, which may be attended by a high volume of paediatric patients;
- b. obstetric ultrasound facilities.

8.19 The above has particular importance where gamma camera PET is utilised, because of the increased radiation protection hazards.

8.20 Delivery routes for radiopharmaceuticals and the relationship with the central hospital pharmacy, including potential staff movements, should be considered in overall planning terms.

8.21 In addition to examination room(s) incorporating one or more gamma cameras and the associated control workstation, the following facilities should be provided, directly supporting the examination room(s):

- a patient injection room/area possibly with limited local lead shielded storage provision for pre-prepared radiopharmaceuticals;
- dedicated disposal facilities for the secure holding of radioactive waste, before disposal, such as partially used doses or contaminated materials such as needles and syringes;
- a dedicated waiting area for pre- and post-injection patients. According to local practice some patients may have to spend long periods (about one hour) here while a suitable time interval elapses prior or during their examination;
- a designated WC for use by radionuclide imaging patients who have received radioisotope injections. The effluent will be radioactive and the drainage system must be designated accordingly;
- a radiopharmacy facility for the preparation of radiopharmaceuticals. The provision of this facility will depend greatly on local arrangements;
- dedicated changing facilities for staff working in radionuclide imaging facilities. A dedicated staff toilet for staff working in radionuclide imaging may be appropriate here;
- office(s) and or reporting facilities for the clinical interpretation of the diagnostic images obtained. This may be a combined facility with other modalities;
- a cardiac stress room may be considered appropriate in some centres.

8.22 Counselling/interview room(s), office(s), reception, utility, storage for non-radioactive materials and preliminary waiting accommodation should be considered, depending on the number of nuclear medicine examination rooms, together with the possibility of sharing these facilities with other diagnostic modalities within a department. In radionuclide imaging facilities provided primarily for oncology, the provision of a counselling room and a reception area may be necessary.

8.23 The gamma camera, injection room, disposal room, designated WC and the radiopharmacy will probably be designated as controlled areas under the 1999 Ionising Radiations Regulations. The suite should be designed to meet the requirements of the 1993 Radioactive Substances Act, the Health and Safety Commission approved code of practice and relevant DoH/NHS Estates guidance. According to local policies, waiting and other areas may be similarly designated. An appropriately qualified RPA must be consulted in the design of the suite.

8.24 The Radioactive Substances Act 1993 stipulates how and where unsealed radioactive substances are used and eventually disposed of as waste. The suite design together with the disposal of radioactive substances must conform to the requirements of this Act, where appropriate. A radionuclide imaging department must obtain authorisations from the Environment Agency for the keeping, use and disposal of radioactive substances. The disposal certificate will stipulate the amounts of radioactivity and species of radioisotopes that can be released to the environment, any solid waste which may be taken to another site for incineration, for example, and the length of time that substances can be stored before disposal. From a facilities management perspective, it should be noted that solid radioactive waste destined for incineration should be marked accordingly and separated from other types of waste.

8.25 Other considerations in particular include the security of radioactive materials within the radionuclide imaging suite.

ROOM AND EQUIPMENT DESCRIPTIONS

The radionuclide imaging examination room

8.26 The gamma camera is a floor-mounted device where the patient may lie on an examination table, which is advanced manually into position for imaging. Alternatively, the patient may be sitting or standing during the examination. In some dynamic clinical studies the patient may be injected with the radionuclide imaging agent whilst being imaged. The gantries of gamma cameras sold by the majority of manufacturers are fixed into position, but one or two systems are

mobile and, in some cases, may be installed on floor mounted tracks. The actual configuration and installation requirements of the camera will vary between manufacturers, with whom there should be careful consultation at the early design stage.

8.27 The doors to the imaging room should be large enough to accommodate patients on beds. Careful consideration should be given in deciding how a patient in a bed is transferred from the injection room to the imaging room, particularly if they are located adjacent to each other.

8.28 The use of multi-detector gamma camera units is gradually increasing within the NHS, as this allows a reduction in the activity of the radiopharmaceutical administered to the patient, a reduction in scan time and possibly of undertaking gamma camera PET investigations. Multi-detector units are generally much larger than single detector units and the space of the examination room should be increased to accommodate this possibility. It is advised that, even if a single detector unit is procured in the first instance, the examination room is made large enough to install a multi-detector system and support Positron Emission Tomography scanning with these units. The units have a useful life of between eight and ten years and, in the majority of circumstances, the building will outlast the use of a single unit. The multi-detector units also weigh more, a consideration that may be important if the imaging services department is not located on the ground floor of the hospital. In this respect, the design of the suite should consider how the individual modules to make up the gamma camera are installed and moved into position within the examination room.

8.29 Ceiling-suspended or wall-mounted equipment and associated support framing is not required for the gamma camera itself, but may be required for single ergonomic "positioning" monitors. The height of the gamma camera does not necessitate exceptional room height. A typical room height of 2.7 m, to the suspended ceiling, will be appropriate.

8.30 Power and control cables serving the gamma camera may feed from the ceiling. Alternatively, if these cables are concealed within the floor construction then a conventional screed depth of approximately 75 mm depth will be appropriate. Radiation protection requirements will need to be assessed in terms of floor construction. The gamma camera requires maintenance access from all sides according to manufacturer's specifications.

8.31 Gamma camera positioning controls may be adjacent to the camera or located in the detector head. A separate workstation will be used to control the imaging procedure and located in the examination room. For radiation protection reasons, this should be located

as far as possible from the actual camera, whilst respecting the need to care for the patient being examined. An additional workstation may be provided. This may be connected to an RIS network, although this maybe integrated with the main workstation. No fixed protective lead-lined screen is required, although a mobile unit may be provided, depending on the radiation protection requirements. However, if gamma camera PET is undertaken, the advice of the RPA should be sought and additional mobile or fixed shielding will almost certainly have to be provided. The energies of the radionuclides used in PET are higher than those used in more conventional radionuclide imaging with technetium, for example, so the radiation hazards are increased greatly.

8.32 In some imaging examinations the camera is rotated 360° around the patient, in order to obtain two dimensional cross-sectional images of the patient's anatomy and physiology. This has particular importance in cardiac applications, where 2D cross sectional images can aid the certainty of diagnosis. In order to facilitate this clinical requirement, clearance space should be left around all sides of the gamma camera to allow the detector to acquire images at different projections around the patient which will then be used to form the 2D cross sectional image. This technique can be undertaken on both single and multi-detector units.

8.33 Collimators are used in association with the imaging of various anatomical sites and when alternatives to technetium are utilised, such as iodine and thallium. They are fixed to the front of the gamma camera detector head and act as focusing devices. They are moved by the use of mobile carts and floor space needs to be allocated for storage for between three and six of these devices, per detector. The area of floor space required for storage will depend on the manufacturer of the equipment and the space allocated should allow for all suppliers' options. Additional specialist collimators will be required for gamma camera PET, which may have further space requirements within the examination room. All systems require a level floor with no localised discontinuities, as this can affect the loading of the collimators. Some systems, particularly those with moving gantries, including multi-detector units, have very small tolerances. This should be checked with potential suppliers and original equipment manufacturers during the design phase. In addition, space should be provided to facilitate the change of the collimator, as this can lead to mechanical damage and staff injury when this is undertaken in a confined space. Moving the patient couch from under the camera during collimator change can lead to distortion of the vinyl and the covering screed. In some cases, the manufacturer may require the placement of pins or holes in the floor to assist with the changing of the collimator. This will be specific to certain manufacturers or types of equipment

and should be checked at the tendering stage for new or replacement equipment.

8.34 If gamma camera PET is undertaken, then additional provision should be allocated for the storage of calibration devices. This is further described in [Chapter 9, PET](#).

8.35 The patient imaging couch/table may move perpendicularly away from and to the gamma camera for patient positioning and in order to allow a patient to stand or sit in the front of the detector or when changing over the collimators.

8.36 Clinical staff will usually remain in the examination room whilst the imaging procedure is carried-out. Typically, a maximum of two staff will be present during the imaging procedure. Thin plastic protective clothing may be worn to protect against contamination hazards. Lead-lined aprons will not be used in this environment.

8.37 Clinical handwashing facilities are required within the examination room. They should be designated and labelled appropriately as "not for the disposal of aqueous radioactive waste". They should be fixed against a tiled area of the wall within the room and fitted with elbow operated taps.

8.38 Changing facilities will not be required, since patients will generally not undress for the procedure. However, one or two lockers in the examination room for storing patient valuables may be a consideration, as personal items such as jewellery may have a detrimental affect on image quality.

8.39 The patients attending for a radionuclide examination will be a mixture of both inpatients and out-patients. One and a half leaf or double doors are required for access by patients on beds to the examination room and space for the transfer of patients from a King's Fund bed to the examination couch.

8.40 The conduct of radionuclide imaging examinations does not normally require patients to be under GA, with the exception of children, where mobile or piped facilities could be considered. Sedation may be used for a minority of adult patients. Some examinations may take up to one and a half hours and images of acceptable diagnostic quality require the patients to remain still for these long periods of time. The design of the room should take this into account and careful consideration should be given to the provision of lighting in the examination room. Space should be provided for a small music system to assist in keeping patients relaxed during the examination.

8.41 The expensive crystal detector within a gamma camera can be damaged or cracked beyond repair if there is a too-rapid rise or fall in temperature (>2°C/hour) or other environmental conditions within the

gamma camera room, usually necessitating the replacement of the whole detector unit. The environmental conditions in the examination room must be appropriately controlled to manufacturer's tolerances and full air-conditioning provided. This will ensure that the equipment operates at optimum performance levels and may also reduce overall downtime. An alarm system should be strongly considered that should be activated in the event of failure of the air-conditioning system or when the environmental conditions are outside those tolerances recommended by the manufacturer. For the majority of gamma cameras, the temperature should remain between 20°C and 22°C with a non-condensing humidity of between 40% and 60%. These figures will vary between manufacturers and should be checked carefully before installation. The doors to the gamma camera room should remain closed whenever possible and be equipped with key-coded locks to prevent unauthorised out-of-hours access.

8.42 If radionuclide imaging examination procedures are to include the use of inhaled aerosols labelled with technetium, ceiling mounted air extraction facilities should be provided. This is to minimise the contamination risks within the examination room and, in particular, to avoid contaminating the face of the gamma camera, which may have a direct impact on clinical image quality. If radioactive gases, such as krypton, are used as alternative to aerosols, it is probably not necessary to make provision for extract ventilation.

8.43 Non-absorbent finishes such as conventional sheet vinyl flooring and skirting, together with walls painted using gloss paint or similar easy to clean wall finishes are appropriate. To minimise contamination risks, particular care should be taken to avoid any gaps in finishes and fixtures in which radioactive materials could become lodged. In essence, the floor covering must be continuously sealed and impervious to spillage, overlapping the walls to provide in situ skirting.

8.44 The bench surfaces should be coved against walls and lipped at the edges to prevent radioactive substances becoming lodged in any cracks between the wall and the bench or spilling onto the floor.

8.45 Aspects of radiation protection in wall and door construction may differ from those in conventional X-ray rooms. The principal source of radiation within the imaging room, in the majority of circumstances, will be the patient and other radioactive sources, rather than the imaging equipment. In general terms, the room must be shielded to meet the requirements of the 1999 Ionising Radiations Regulations.

8.46 If two or more gamma camera rooms are adjacent, possibly installed into an open plan area, mutual radiation effects and "cross talk" may need to be assessed and the gamma cameras installed appropriately. The use of mobile lead-lined shields may

be used to minimise cross talk between two cameras. The manufacturer and the RPA should be consulted if the two units are to be installed into a single examination room. This can be a particular problem during servicing and when clinical work continues on the other or when one of the detector units is rotated through 360° to produce cross-sectional images. A similar problem may arise, particularly with small installations, where the gamma camera or imaging detector may detect radiation emanating from patients in the sub-waiting area. Care should be taken over the design relationship between the entrance door to the camera room, sub-waiting area and the orientation of the gamma camera in the imaging room.

8.47 Two-stage warning lights, such as those used in X-ray installations, are not necessary in this instance. However, appropriate signage should be appended to the entrance doors. This should be discussed with the RPS and the RPA.

8.48 Large power cabinets, such as those found in general X-ray rooms, are not a feature of this type of equipment.

8.49 Additional storage space may need to be included within the room for QA phantoms, general clinical disposable items, a decontamination or spill kit and patient positioning aids.

8.50 In some instances, the equipment may be supplied with a large low level radioactive source, sometimes called a flood source for QA purposes. For operational reasons, this should be stored in the imaging room, as it may be used on regular basis (one to two times per day), or in the radiopharmaceutical preparation area, if one exists. A heavily lead shielded cupboard should be set aside for the storage of this equipment.

Cardiac considerations – stress room

8.51 Where cardiac investigations are undertaken, space should be allocated, either within the imaging room or in a separate room directly adjoining the main imaging room, for the additional equipment and staff required to facilitate the latter part of the procedure. As stated above, depending on the approach, room may need to be provided for a bicycle or treadmill. The location of these units will depend on the overall space available and the decision to provide an additional stress room should be made at local level.

8.52 If pharmacological stressing is undertaken, then a locked drugs cupboard should be provided in the room to house the drugs used. This can also be used to store sedatives and other controlled drugs. In this case, the use of bicycles and treadmills will not usually be required.

8.53 In either case, the imaging room and possibly separate stress room should allow blood pressure monitors, ECG equipment and other types of monitoring equipment to be connected directly to the patient. Resuscitation equipment and controlled drugs should also be made easily accessible.

8.54 The design of the department should enable patients undergoing cardiac investigations to be readily accessible to cardiologists in the event of an emergency. To this end, an alarm system should be installed in the room to request the assistance of the resuscitation team if required.

Viewing and reporting facilities

8.55 Depending on departmental, facility or hospital arrangements, provisions for the processing and distribution of diagnostic images will need to be considered in planning terms.

8.56 Gamma cameras generate a digital image, which is initially viewed at the control workstation within the examination room or adjacent office. The radiographer, possibly with the assistance of an appropriately qualified consultant radiologist, will review the images acquired for technical and diagnostic quality. The diagnostic images acquired can then be passed along one of the following routes:

- a. stored locally to a hard drive or disk with local data back-up procedures;
- b. stored to a CD-ROM and taken to another workstation for reviewing or interpreting. Secure storage space, within the radionuclide imaging suite or the department as a whole, must be allocated for CD-ROMs if this option is used;
- c. hard copies may be generated at local or remote laser printers;
- d. transferred to another workstation within a LAN, in the radionuclide imaging suite for reviewing, reporting or storage. This digital workstation may be shared with other modalities such as CT, MRI or dedicated PET, for example;
- e. images are stored on a central hospital digital archive as part of a hospital wide networking strategy.

8.57 The images acquired will be reported following completion of the examination by an appropriately qualified radiologist.

8.58 According to the level of provision, dedicated reporting and viewing facilities may be provided within the suite or alternatively shared with a wider diagnostic imaging department. An early decision is required on this operational policy.

Injection room

8.59 In this area, the patient will be administered with a radiopharmaceutical in preparation for their examination. This may take place one to three hours before imaging. An out-patient may be sent away, with appropriate radiation protection information, and requested to attend at a later time. Bed access to this room should be provided for in-patients. In all cases, a separate room with a door should be provided for the administration of radiopharmaceuticals to patients. This should not be part of the radionuclide imaging room.

8.60 This area may accommodate a patient couch, transiently a King's Fund bed, a specialised seat to facilitate intravenous administration, a drugs cupboard, an appropriately labelled clinical handwashing basin, and a general preparation worktop, together with an appropriately designated inset sink for radioactive waste disposal. The sink should be located against an area of the wall that is fitted with tiles, to allow easy cleaning of any radioactive substances that may have splashed from the sink.

8.61 Lead-lined storage containers should be provided for small items of solid radioactive waste, such as sharps and syringes. Provision of a fixed lead-lined shield, possibly built into the worktop, may be required for operators to manipulate the radioactive substances safely. The thickness of such lead shielding will probably be greater for radiopharmaceuticals used in gamma camera PET procedures. A patient weighing machine may also be required in this area.

8.62 Where radiopharmacy provision is remote to the radionuclide imaging suite then additional sterile, lead-lined storage containers will be required for the storage of radiopharmaceuticals. If the department incorporates a radiopharmacy, a hatch should be provided between the radiopharmaceutical preparation area and the injection room.

8.63 Ceiling, wall and floor finishes should be equivalent to those described for the gamma camera or imaging room. The construction of the walls, floor and ceiling of the injection room may have to incorporate some form of lead shielding in accordance with the 1999 Ionising Radiation Regulations. The RPA should be consulted in this regard.

Low level radioactive waste disposal area

8.64 A holding facility for larger amounts of low level radioactive waste, such as contaminated bed linen – either from the suite or the wards – or materials used to mop up spillages – should be provided within the radionuclide imaging suite. This could take the form of a small built-in cupboard or a separate room, accessible from all areas of the suite, incorporating radiation

protection such as lead blocks. The weight of the lead blocks may be considerable, making structural reinforcement of the floor necessary.

8.65 In some instances, this disposal store may be used to house “single use” nebuliser kits utilised in lung scanning, which due to the inefficiency of the technique may still contain relatively high levels of radioactive substances. Since these items may need to be stored in their original form, they may be bulky. This room may need to incorporate some structural radiation protection in the design of the walls and door, in addition to the lead blocks mentioned above. The need for this will depend on local circumstances, the storage of equipment used in therapeutic administrations and the current and future operational requirements for this facility.

8.66 In the majority of cases, these rooms will contain contaminated articles, which may be pungent and the cupboard should be located in a well-ventilated area.

8.67 The general ceiling, wall and floor finishes should be equivalent to those outlined for the gamma camera or imaging room.

Waiting area

8.68 Provision should be made for an adjacent designated sub-waiting area, sized according to anticipated patient numbers, and allowing for spacing between seats and for possibly extended waiting times. As stated above, patients may have to wait an hour or more between the administration of the radiopharmaceutical and the imaging procedure.

8.69 Patients may be allowed to leave the suite following an injection and before imaging, according to local policies and following basic radiation protection advice from the radiographer. In addition, early local policies should be made, describing whether patients who have been administered with radiopharmaceuticals (hot patients) should be segregated and describing the facilities to be provided for accompanying adults and children. It is recommended that, where space is available, separate waiting areas should be provided for “hot” and “cold” patients. The size of the waiting area and the facilities provided will depend to a greater or lesser degree on these local and operational policies, which should be determined at an early planning stage. Refreshments and entertainment facilities should be provided for those patients who are unable to attend the hospital canteen, for example.

8.70 Under certain circumstances, and depending on local rules and policies, the waiting area may be designated as a controlled area. The project team, working with the RPA and superintendent radiographer, should decide at an early stage whether or not the

waiting area should be designated as such, at any time during operational hours. This will have implications for facility design, such as the need to physically separate the waiting area from the general circulation area. If the waiting is designated a controlled area, there will be a requirement to exclude non-patients, except comforters and carers. Any escort nurses will have to enter the area under a system of work.

8.71 The seating provided in the waiting area of a radionuclide imaging suite should have non-absorbent, wipe clean, finishes, to minimise contamination risks arising from incontinence. Ideally, fixed seating should be provided to achieve a spacing between seats of approximately 0.8 m, when measured centre to centre, even if hot patients are segregated, as the room may be subject to transient periods of over population.

8.72 In the case of Gamma Camera PET, the patients will need to remain relatively at rest, in the sub-waiting area, to avoid muscular uptake of radiopharmaceuticals. The time between administration of the radiopharmaceutical and the imaging procedure is approximately one hour. Consideration should be given to the increased radiation protection hazards in this connection. With PET patients, for example, greater separation of the seats may be appropriate. See also Chapter 9 on PET. It may be clinically advantageous to provide gamma camera PET patients with a small waiting room containing a couch, in order to minimise uptake of the radiopharmaceutical in the muscles. This may also solve any radiation protection issues.

8.73 Walls and floor finishes should be non-absorbent and easily wiped clean and should be designed to meet the standards of finish provided for the imaging and injection rooms.

Radionuclide imaging toilet

8.74 A separate toilet facility within the suite needs to be provided for patients who have received an intravenous administration of a radiopharmaceutical substance. The urine and possibly the faeces from these patients may be radioactive. The toilet should be designated for use by radionuclide imaging patients only and also designated as a controlled area under the 1999 Ionising Radiation Regulations and subject to the stipulations of the 1993 Radioactive Substances Act. This room should not be located on a main corridor of the imaging services department, as this may spread any contamination to general circulation areas. Ideally, the toilet should only be accessible from the main patient sub-waiting area. The room may need to incorporate some form of radiation shielding using bricks or concrete, and this should be undertaken in consultation with the RPA.

8.75 Conventional non-absorbent floor and wall construction and finishes will be appropriate in this area, to minimise contamination hazards. All spills will be treated as contamination by aqueous radioactive substances and should be cleaned up by the use of absorbent materials.

8.76 In all other respects this will be a standard WC and should allow for wheelchair access.

8.77 There may be a requirement for a sluice in the designated toilet to deal with bed-pans from bed bound patients.

8.78 Separate non-designated WC facilities should also be provided for staff, relatives and friends accompanying the patients, possibly within the suite or as part of a larger department shared with other modalities.

Staff changing facilities

8.79 To assist with the management of contamination risk, consideration should be given to separate changing facilities for staff working in radionuclide imaging. This should include conventional lockers and hand held radiation monitoring equipment and may be combined with a dedicated staff toilet.

Showers

8.80 Showers should not generally be provided within the radionuclide imaging suite for decontamination purposes. Showering will have the affect of spreading any localised contamination over the entire anatomy.

THE RADIOPHARMACY

8.81 See the plans in [Appendix 1](#).

8.82 Radiopharmaceutical production requires highly specialised facilities, together with trained staff and a lead radiopharmacist. It may, therefore, be appropriate for radiopharmaceutical production to be undertaken in one or two regionally designated centres, which will deliver radiopharmaceuticals to other hospitals undertaking radionuclide imaging investigations. This chapter describes the radionuclide production for imaging examinations only. The production of radiopharmaceuticals for therapeutic purposes is described in the NHS Estates guidance on facilities for cancer care services. However, the authors recognise that radiopharmaceutical production for therapeutic use may be undertaken as part of the same facility and therefore the reader is encouraged to combine the information in both sets of guidance when designing a new facility. Consultation with oncologists is advised to determine the extent of the therapeutic procedures proposed and how this may affect the design of the built environment.

Radiopharmaceutical production

8.83 There are two methods of producing radiopharmaceuticals. These are defined as closed and open procedures and are briefly outlined below.

Closed procedures

8.84 Pharmaceuticals in vials, otherwise known as kits are procured from a manufacturer and the radioisotope, usually Technetium 99m, prepared in the department, is added to form the radiopharmaceutical. In this instance, adding the contents of one vial to another forms the radiopharmaceutical. Each completed vial can contain several patient doses.

Open procedures

8.85 Open procedures are where the ingredients are mixed together in open environment in the radiopharmacy and added/mixed with the radioisotope to form the radiopharmaceutical. This is then broken down to form the separate patient doses. Higher standards of cleanliness are required for open procedures.

8.86 The design requirements of the radiopharmacy suite to support open or closed procedures are similar and are described below.

8.87 White blood cell labelling is an example of an open procedure. It is mentioned here to highlight the fact that where this procedure is undertaken, an additional aseptic preparation room should be provided. Otherwise, it is comparable to any other radionuclide imaging procedure. Further details are given below.

Radiopharmacy design

8.88 When designing a new radiopharmacy facility, it is important to consult with the RPA, lead radiopharmacist, RPS, the infections control officer and at least one radiologist with an Administration of Radioactive Substances Advisory Committee (ARSAC) certificate, throughout the entire project.

8.89 The preparation of radiopharmaceuticals differs from normal pharmaceutical agents in that there is a need to protect the operator and the local environment from ionising radiation. A number of measures have to be incorporated to protect against this potential hazard and they are described in the text below.

8.90 The radiopharmacy should either be planned to be adjacent to or a part of the radionuclide imaging department. Ideally, it should be on the ground floor of the hospital, but this will depend on the space available. It should not create a new hazard to existing areas or personnel working in the hospital. The radiopharmacy

should be designed to allow for an expansion in service requirements.

8.91 It may form part of a larger pharmacy department. If this is the case, the relationship between the pharmacy department and diagnostic imaging and interventional radiology departments then becomes critical. See also Health Building Note 29, 'Accommodation for pharmaceutical services'.

8.92 Radiopharmacy departments should be planned to be a large distance away from units undertaking tracer studies. The high levels of radioactivity from the radiopharmacy unit may interfere with the low level counting equipment used in the tracer units.

List of accommodation

8.93 The list of accommodation for a radiopharmacy suite is as follows. This is in addition to the accommodation described above for the radionuclide imaging suite:

- aseptic rooms(s) for the preparation of the radiopharmaceuticals by closed, open and white blood cell labelling procedures;
- an entrance area or air-locked lobby to the aseptic rooms;
- an area for staff to change into aseptic clothing which maybe combined with the air-locked lobby;
- a preparation area for the holding of pre-prepared radiopharmaceutical, syringes and other technical items of equipment such as radio-isotope calibrators, located directly next to the injection room;
- a small cupboard area with an outside hatch to allow for the delivery and return of the radioisotope generators and of radiopharmaceuticals;
- an additional injection room maybe required for undertaking tracer studies;
- an additional aseptic room for the preparation of Iodine 131;
- a store for the waste radioactive substances, if required, in addition to a waste store provided in the radionuclide imaging suite. Different storage areas may need to be provided for categories of waste, for example sharps, used vials, soiled bed linen;
- an office for undertaking general administration duties including QA procedures.

Delivery of radioisotopes

8.94 Radiopharmacies will require the delivery of a molybdenum generator, which will be provided by a specialist manufacturer and is used to produce the

radio-isotope Technetium 99m. This is sometimes called a "molybdenum cow" and is on average 400 mm³ in volume and can weigh up to 5–10 kg. Arrangements will need to be made for the secure delivery of these units into the radiopharmacy and for the removal of the old generator, approximately once per week. A system will need to be devised for safe confirmed delivery and storage, and sometimes this may be by non-specialist staff out of core hours. One generator will usually meet the imaging requirements for an entire week. These units, when delivered, usually contain high activities of the radioisotope, usually of the order of 100 GBq. As a result, the units are heavily shielded to minimise the radiation doses to persons transporting and handling these devices. Even when the generators are returned to the contractor, their residual activities can be between 0.5 and 10 GBq. This delivery and return route will apply for all radioisotopes brought into the radiopharmacy, including those potentially used for therapeutic purposes.

8.95 Separate radioisotope units may be required for discrete examinations and can be used without any further preparation, such as the technetium aerosols used in lung ventilation imaging. The delivery store cupboard could be used to bring these items of equipment into the department.

8.96 The radioisotopes should not be brought into the radiopharmacy by moving them through public areas of the hospital, as this increases the risk not only to delivery staff, but also to persons in these areas, if there is a small accident or a spill of radioactive material. If this is not possible, then arrangements should be made with the transport company for the delivery or collection to be made either early in the morning or late at night when there maybe only few members of the public and staff present.

Small cupboard area with outside hatch

8.97 If the department is on the ground floor, as recommended, it is advised that a small store room is formed, which can be accessed by contractors transporting the molybdenum generators, and by members of staff from inside the building. Access to the store area should be by key entry only from both sides. It is advised that the store is not located within an aseptic or preparation area, for infection control and contamination reasons, but close to this area, possibly as part of lockable storage area or cupboard. This would not be the same as the waste disposal room for radioactive substances described below. The store could also be used to transfer radiopharmaceuticals from the radiopharmacy to other hospitals, if required. There may be a requirement to incorporate some form of radiation shielding in the structure of the store, but this should be discussed with the RPA.

Aseptic room – open and closed procedures preparation area

8.98 The preparation, manipulation and dispensing of radiopharmaceuticals should be undertaken in an area that is filtered with air that meets Class (i) microbiological standards and a Grade A environment should be achieved in respect of British Standards (1988 Guidance for the protection of persons against ionising radiations arising from medical and dental use). This is usually achieved by installing a closed, multi-compartment downward laminar flow cabinet, sometimes referred to as an isolator, within the room. Normally a single operator will work at this cabinet.

8.99 In order to achieve air filtered to Class (i) standards, the cabinets will be supplied with air through a HEPA filtration system. The filter will need to be changed on a periodic basis and as such arrangements for maintenance of this cabinet should be considered.

8.100 The air from the cabinets should be vented to the outside of the hospital, in conformance with the Environment Agency Standards identified on inspection, and the exhaust duct from the venting system should sit 3 to 4m above ground or floor level of the actual building. The exhaust duct from the venting system should not be vented to public areas and, ideally, should be located on the roof of the building. However, local rules and systems of work may still have to be instigated to prevent members of the public or staff becoming lightly contaminated with radioactive substances, particularly if the exhaust vent is placed on the roof of the building. The venting should be separated from other systems used by the hospital, and the exhaust duct should not be placed near windows or entrances. The air from the cabinet should not be vented to other adjoining rooms or into the aseptic preparation room, as radioactively contaminated airborne particles may move to adjoining spaces. The venting from the cabinet should be designed to be fire resistant, non-absorbent and easily dismantlable in sections. Further advice on venting aspects should be requested from the RPA, as appropriate.

8.101 For open procedures described above, the air supply to the room should be filtered to meet Class (iii) standards. Again, this can be achieved by the use of a filtration system, where the filters will need to be changed on a periodical basis. The room should be maintained at positive air pressure when compared with other areas or spaces.

8.102 The technetium/molybdenum generator would be stored in the base of the laminar flow cabinet and the radiographers, for the production of Technetium 99m, would elute this unit once or twice a day. The generators should therefore be kept in a grade A environment. In many cases the generator is kept for

two weeks and can present the highest aseptic risk. By comparison, normal radiopharmaceutical kits are kept in prepared form and used within eight hours.

8.103 The safety cabinets should incorporate lead glass windows, for the protection of the operator when manipulating the radioactive substances or eluting the molybdenum generator. In addition, small lead glass shields may be placed in the cabinet to provide further protection for the operator. The elution of the generator would take place within the safety cabinet to maintain aseptic preparation conditions.

8.104 The number of cabinets required will depend on operational requirements and the number of doses which need to be made up on weekly or daily basis.

8.105 For the radiation protection of the adjoining areas to the aseptic room, it is advised that the walls be constructed of dense concrete or brickwork masonry, indicative density of 2250 kg/m³ with a minimum thickness of 225 mm. In the majority of cases, the physical radiation protection from these masonry walls, the design of the laminar flow cabinet and the use of local radiation protection devices, such as small lead screens, should be adequate to meet the requirements of the 1999 Ionising Radiation Regulations. However, particularly where high occupancy factors are expected for the adjoining rooms including, possibly, those above and below the radiopharmacy, additional lead shielding may have to be integrated into the design of the walls ceiling and floor. In some cases, this may simply take the form of lead shielding behind the laminar flow cabinet. The RPA should be consulted in respect of radiation protection requirements.

8.106 The area will almost certainly be designated a controlled area under the 1999 Ionising Radiation Regulations. Illuminated two stage warning signs are not required in this instance, but the doors should be fitted with appropriate signage to indicate the presence of a controlled area. The RPA should again be consulted as to the status of the room with respect to radiation protection.

8.107 An alternative approach to providing aseptic conditions may be to provide a room with air filtered to much higher quality standards than those suggested above. In this case, the cabinet used to manipulate the radiopharmaceuticals may be designed to meet Class (ii) microbiological standards. This may make handling of the radioactive substances and pharmaceuticals easier for the operators and may prevent accidents and any repetitive strain injuries (RSI), for example. If such an approach were used, then a separate changing area and airlock should be provided as described below. This approach may not be appropriate for some preparations and the standards of air quality provided in both the cabinets and the design of the rooms should be

checked with the radiopharmacist and infections control officer before installation.

8.108 The design of the surfaces should be similar, but to a higher quality to those described for the imaging room and injection room. The surfaces should be non-absorbent, with the skirting overlapping the edges of the walls and every effort should be made to minimise fissures in the overall finish of the suite. Stainless steel finishes should not be used, as they absorb some types of radio-isotopes and can be difficult to decontaminate. The ceiling should be made so that it is continuous and imperforate. The use of de-mountable ceiling tiles is not appropriate in this instance. This is to minimise the amount of dust, which may collect in the ceiling and increase the infection and contamination risks within the aseptic room. The walls should be finished in order to make them easier to wash down in case of a radioactive substance spill and to minimise the hazards from infection. Alternative finishes may include specialist paints, as used in operating theatre and other environments or possibly laminate/plastic faced panelling systems with sealed joints.

8.109 The room will need to contain a number of lead shielded waste-bins to allow for the short-term storage of radioactive substances in addition to the normal waste disposal facilities. Overall, the room should allow for a maximum of three persons working and a small amount of bench space should be provided close to a hatch that adjoins directly to the preparation area described below. Cupboards and storage space should be provided for essential items only. Non-essential items, such as those not used in preparing the

radiopharmaceutical, should be stored in the adjacent preparation area.

8.110 The aseptic room will be checked for cleanliness at regular periodic intervals, by the use of settle plates and swabbing of bench surfaces. The plates will probably be checked at a remote microbiology unit and arrangements should be made for transfer between these facilities.

Access area to the radiopharmacy aseptic preparation area

8.111 The entrance to the radiopharmacy suite should be marked with a fixed floor step. Before entering the main corridor to the suite of rooms, or separate radiopharmacy suite, members of staff should put on over-shoes and hair covers to minimise contamination and infection risks. These should be located near the floor step and facilities provided for their disposal.

8.112 Where open procedures are undertaken, access to the radiopharmacy should be through a changing area, followed by a small entrance area or an airlock. For closed procedures, the same should apply, but where space is limited, it is acceptable to combine the functions of the staff change area and airlock as the main entrance to the aseptic preparation room. The activities in this area would then be combined.

8.113 The surfaces within the staff change and entrance areas should be similar to those described for aseptic preparation room. The design characteristics of these areas are briefly described below.

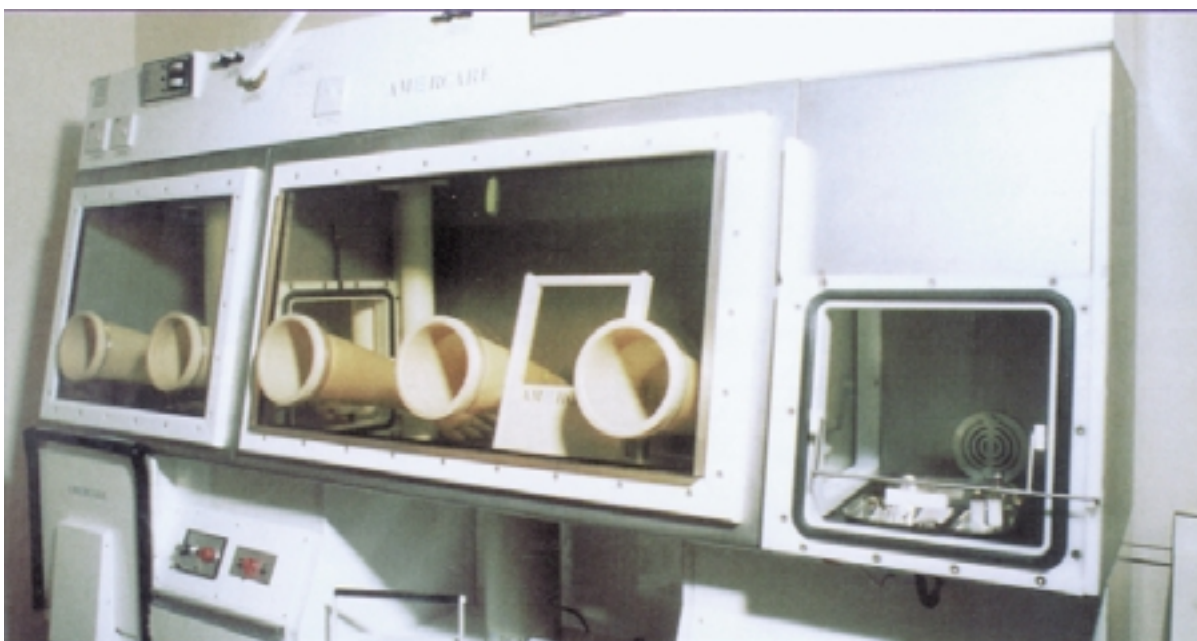

Figure 8.3 Class (I) microbiological safety cabinet used in the preparation of radiopharmaceuticals. Image supplied by Wardray Premise.

Staff change area

8.114 The extent of changing facilities will depend on local infection control policies. Staff may wear masks, overshoes and over-gowns whilst working. Alternatively, facilities may be provided to allow full changing into operating theatre style clothes.

8.115 Entrance to this area should be over a floor fixed step-over bench, which acts as a demarcation between restricted and non-restricted areas.

8.116 The area should contain aseptic clothes for members of staff to change into before entering the aseptic preparation room. In addition, a scrub sink or handwash basin should be included within the changing area.

8.117 A light may need to be placed above the entrance door to the changing area to indicate that it is occupied. A clothes skip should be provided for the disposal of used articles of clothing in preparation for laundering.

Entrance lobby or airlock

8.118 The entrance area or airlock should be kept at slightly higher air pressure than the adjoining corridor or changing area and slightly lower air pressure than the aseptic room(s). The door to the small entrance area should be interlocked with the door to the aseptic room. Any items that may be taken into the aseptic room may also be disinfected in this area by the use of simple alcohol swabs or sprays. A small amount of workspace should be included in this area to allow for this procedure. A pass-through hatch, for example for the generator, may be required depending on local operational requirements and design.

8.119 Magne-helix monitoring dials should be installed on the corridor side of the lobby to indicate relative air pressures in the cabinet, aseptic room and the lobby. Provision should be made for the pattern of airflow from the aseptic room to the corridor via the lobby and possibly a changing area. This will require filters or dampers, which will be built into the intervening doors or walls.

Adjacent preparation and storage area

8.120 This space should adjoin the aseptic room and, ideally, the injection room for the administration of radiopharmaceuticals. In such instances, the transfer of materials could be via the use of hatches. This will allow easy transfer of prepared radiopharmaceuticals directly from the aseptic area to the injection room. The pass-through hatch between the preparation area and aseptic room should be provided with two sets of doors forming an airlock so that air pressure differences between these two areas can be maintained. This should apply if either open or closed procedures are undertaken.

8.121 This room should contain storage space for sundry clinical items such as syringes and swabs. Alternatively, longer term storage of these items may require cupboard provision in adjacent corridor space. Bench space should be allocated to allow persons working in the area to prepare individual doses and check the activity of the radiopharmaceutical before it is administered to the patient. In addition, a sink for the disposal of radioactive substances should be installed in this area and should be designed and marked appropriately. This area should allow for two to three people to work comfortably in this environment. The floor, bench, ceiling and wall surfaces should be similar to those described above for aseptic handling areas, to maintain good infection control.

White blood cell labelling aseptic room

8.122 To meet the requirements of the relevant codes of practice identified by the Health and Safety Executive on inspection, some procedures should be undertaken in separate aseptic rooms. This mainly relates to the labelling of white cells with Technetium 99m or Indium-111, used in the diagnosis of infection. The preparation of these types of radionuclide imaging agents has to be undertaken in a separate, possibly smaller, aseptic room installed with an laminar flow cabinet such as those described above. The air supply to this room should be filtered to meet Class (ii) standards and Grade B environment should be achieved. There should be a changing area and air-lock to the means of gaining access to the room and there may be some economies of scale by putting more than one aseptic room in a back to back arrangement, so that changing facilities and the airlock entrance can be shared. Additional bench space, above that already described, should be provided to allow for the processing and centrifuging of initial red blood cell samples.

Facilities management

8.123 Cleaning of the radiopharmacy aseptic and changing areas may be undertaken by members of staff who work in the department, as specialist cleaning methods may be employed. These members of staff should be aware of the radiation hazards that exist. However, domestic staff, who should be made aware of potential risks involved, may clean other areas of the radiopharmacy.

8.124 Domestic staff who work in the radiopharmacy will need to be provided with some radiation protection training with respect to the use of unsealed radioactive sources. They should to be monitored for whole body radiation doses by the use of a film badge or other monitoring equipment. In addition, a discrete set of cleaning equipment should be set aside for use in the radiopharmacy suite and marked appropriately.

Special engineering requirements including drainage

8.125 Please refer to Engineering requirements, [Appendix 2](#).

MOBILE GAMMA CAMERA – SPECIAL CASE

8.126 This is generally regarded by clinicians in charge of most large centres as a luxury, with very little use in the clinical environment. Instead, most departments will meet clinical and operational needs with centralised and permanently installed facilities. If purchased, consideration has to be given to:

- even floor levels, since mechanical shock can damage the crystal;
- restriction of camera movement under cover, especially in winter. Temperature change greater than 3°C/hour is likely to crack the crystal;
- need to keep machine switched on at all times. It must be connected to mains during storage and use and must be battery powered during transit. This is because gamma cameras are notoriously unstable and take 24 to 48 hours to stabilise from cold;
- consideration of radiation needs is required. Advice from the RPA and RPS should be sought.

9 Positron Emission Tomography units without cyclotron provision

BACKGROUND AND INTRODUCTION

9.1 Positron Emission Tomography (PET) is a diagnostic imaging procedure that provides clinicians with information about the body's physiology and metabolic processes. In principle, PET is similar to radionuclide imaging. However, radiation levels associated with PET are significantly greater, because the energies of the gamma rays produced are almost four times as high. The additional radiation protection requirements for the construction of facilities and precautions in handling materials must be taken into consideration when planning and designing PET facilities or when adapting existing diagnostic rooms.

9.2 In PET, the patient receives a particular category of radiopharmaceutical, incorporating a radioactive substance that emits positrons. As these positrons encounter electrons, they annihilate to form two photons or gamma rays, which are emitted in diametrically opposed directions.

9.3 The patient is positioned in the centre of the bore of the PET scanner, which is similar in some aspects to the size and shape of a conventional single slice CT scanner as described elsewhere in this guidance. The patient is positioned on a table, which forms an integral part of the scanner. Scintillation Crystal Detectors, similar to those used in gamma cameras, are positioned within the scanner structure in a continuous wrap-around array. They are used simultaneously, to detect the gamma rays emitted.

CLINICAL AND OPERATIONAL OBJECTIVES

Production of radionuclides used in PET

9.4 The radioactive substances used in PET can only be produced using a specialised facility called a cyclotron. Due to the short half-life, between one to two hours, of the radioactive substances used, a PET facility needs to be located near to a cyclotron. If a cyclotron is not available on site, as is the case for the majority of NHS trusts, then it should be available within two hours' travel time.

9.5 The radiopharmaceutical utilised in the majority of PET scanning is a glucose compound labelled with Fluorine-18. This is commonly known as fluoro-deoxy

glucose or FDG. Alternatives to fluorine include Oxygen-18 labelled compounds.

Clinical applications

9.6 Since the radiopharmaceutical incorporates a chemical commonly used by the body, PET enables the physician to see the location of areas or volumes of tissue that have a higher metabolic process or rate. For example, FDG will demonstrate secondaries associated with lung cancer, which may be growing near the heart and not easily detected by other modalities, such as CT or MRI (see 'Metastases from non-small cell lung cancer: mediastinal staging in 1990s – meta analytic comparison of PET with CT'). This technique can have a high impact on the patient's care pathway and treatment. The use of PET is being investigated to detect other types of secondaries associated with other tumour types. Evidence is now being published that PET has a useful role in reviewing the benefits/risks of chemotherapy and radiotherapy, potentially reducing the need for surgery. PET can also be used for infection imaging and in neurological applications where patients have a specific type of epilepsy.

LIST OF ACCOMMODATION AND LOCATION OF PET FACILITIES

9.7 Please refer to the plans in [Appendix 1](#).

9.8 PET facilities can be provided:

- in association with other radionuclide imaging facilities, as part of a suite with shared supporting areas such as sub-waiting;
- in association with other modalities such as CT and MRI. Co-registration of PET and other diagnostic images is being developed. Evidence for the clinical benefit of this mathematical procedure is being collated;
- in association with a cancer treatment centre due to its primary capabilities of detecting metastatic disease.

9.9 Many aspects of PET scanning procedures, and of the associated requirements for space and equipment, are similar to those of radionuclide imaging in general,

and reference should be made to the design guidance for radionuclide imaging, elsewhere in this document.

9.10 PET services could be provided using the following equipment and facilities:

- a. a purpose designed suite of rooms forming a dedicated PET facility;
- b. installing a PET scanner in adapted gamma camera room;
- c. conventional double detector gamma camera, which will be used in the majority of applications for conventional radionuclide imaging, but occasionally will also be used for PET clinical procedures.

9.11 The following text relates to a dedicated PET facility but some reference is also made to options (b) and (c) above.

9.12 In addition to the PET imaging room the following facilities should be provided:

- a dedicated patient injection room possibly with local lead shielded storage provision for pre-prepared radiopharmaceuticals;
- a separate control-room, if the facility is scanning a relatively large number of patients. This is because of the increased radiation risks;
- disposal facilities for the secure holding of radioactive waste, before disposal, such as partially used doses or contaminated materials such as needles and syringes;
- a dedicated waiting area for pre and post-injection patients. The majority of PET patients will have to spend long periods here while a suitable time interval elapses prior to or during their examination;
- a designated WC for use by PET patients who have received radio-isotope injections. The effluent will be radioactive and the drainage system must be designated accordingly;
- a cyclotron incorporating a radiopharmacy facility either at the trust or on a nearby site;
- a facility for the handling and disposal of radiopharmaceuticals;
- dedicated changing facilities for staff working in PET facilities. A dedicated staff toilet for staff working in radionuclide imaging may be appropriate here;
- office(s) and/or reporting facilities for the clinical interpretation of the diagnostic images obtained. This may be a combined facility with other modalities.

ROOM AND EQUIPMENT DESCRIPTIONS

PET imaging or examination room

9.13 The PET scanner, in the majority of cases, is a floor-mounted unit with an integral patient table. In essence, scanner installation requirements are similar to those for larger gamma cameras, in respect of ceiling mounted equipment and the provision of cabling.

9.14 A clinical wash-hand basin should be provided, designated and labelled “not for the disposal of radioactive waste”.

9.15 Shielded storage space will be required for radioactive calibration equipment used to perform attenuation corrections on the PET scanner. This can be in the form of adapted cupboards, which may be built in under worktops, either within the imaging or radiopharmaceutical room, depending on local requirements. Typically, 5 mm thickness of lead sheet is utilised.

9.16 General storage, in the form of wall-mounted and base units under worktops, will probably be needed for clinical related items such as linen for the table, blankets and other items such syringes. Storage will be needed for QA “phantoms” in a variety of sizes and numbers. Phantoms can usually be accommodated in standard base units. A small amount of space should be allocated for a spill kit.

9.17 Due to the higher energy of the gamma rays involved with PET, the construction radiation protection requirements may be greater than those associated with X-ray rooms or radionuclide imaging. This depends on the size of the facility and number of patients scanned on a daily basis. As an indication, 5 mm-lead sheet protection may be required in doors, and observation panels. For the internal and external walls 200 mm of 2300 kg/m³ dense concrete masonry may be appropriate in a unit that is fully utilised. Comparable protection will be required where there are occupied areas below or above.

9.18 Windows should not be installed but a roof light maybe considered in appropriate circumstances with roof top access controls if necessary. The RPA should be consulted.

9.19 The scintillation crystal used in PET is made of similar materials as to those used in gamma cameras and equivalent limitations apply in respect of control of environmental conditions such as relative humidity and temperature control.

9.20 Decoration, room lighting and provision of facilities such as taped music should all be considered, as patients will be usually be conscious and imaging procedures have a duration of usually between 30 and 90 minutes.

9.21 The room finishes should be comparable to those in a gamma camera imaging room to avoid radioactive contamination problems.

9.22 The position and orientation of the scanner should allow easy observation of the patient during a scanning procedure from the adjacent control room.

9.23 A computer cabinet is supplied in support of PET scanners to undertake the necessary image mathematics. It is comparable in size to a filing cabinet. It can be sited in the scanner or control rooms, depending on space requirements. Maintenance access will be required.

Control room

9.24 A separate control room should be provided adjacent to the scanner room, linked by a connecting door and observation screen.

9.25 The functions that will be carried out in this room will include administration, control of the scanning process, observation of patients and initial review of diagnostic images acquired, using either a workstation or conventional film viewing boxes.

9.26 Storage space should be allocated where images are stored to magnetic or optical storage media either locally or in another remote location. Hard-copy images may be generated using a laser imager, which may be located in the control room or elsewhere as part of a larger department network.

9.27 General low and high-level storage cupboards/shelves should be provided in this area for folders, papers, manuals and other supporting materials.

9.28 Worktop provision will be required for a minimum of one computer workstation, which will be used to acquire the PET images. Further workstations may be installed, depending on technological development and integration, operational requirements to support the following functions.

- a. to enable an interface with the RIS network;
- b. a teleradiology workstation to allow images to be distributed to other hospitals and radiologists' homes;
- c. cross-sectional imaging workstation. Ideally, this should be located in a shared reporting area, also supporting other cross-sectional imaging modalities.

9.29 Local provision of air conditioning, possibly in the form of cassette coolers or units, may be required for dealing with heat loads associated with the computer equipment used.

9.30 There should also be separate direct access to a corridor or other shared areas. During scanning, at least one radiographer will be present in the control room and will intermittently check on the patient in the PET scanner room. As many as three staff may simultaneously occupy the control room. These will be two radiographers and one radiologist.

Facility for the handling and disposal of radiopharmaceuticals

9.31 Radiopharmaceuticals are pre-prepared in vials at the cyclotron. Each vial contains multiple FDG doses. Vials are transported in appropriately labelled sealed Class A containers, as designated under the Carriage of Dangerous Drugs (Classification, Packaging and Labelling) and Use of Transportable Pressure Receptacles Regulations 1996. Radiopharmaceuticals will be delivered directly to the PET suite, possibly by an outside access door directly to the superintendent radiographer.

9.32 Members of staff will not wear lead coats when handling the radiopharmaceuticals, but they will wear lab overcoats, gloves and overshoes, similar to those worn during radionuclide imaging.

9.33 Materials and finishes in the preparation area should be non-absorbent and equivalent to those described for an injection room in a radionuclide imaging suite. Small-scale monitoring equipment will be kept in the handling and preparation room and used for frequent monitoring of radioactivity levels.

9.34 Small contamination accidents may infrequently occur when preparing the radiopharmaceuticals for intravenous administration. A spill kit will be required as described in Radionuclide imaging, Chapter 8. Facilities should be provided for the disposal of contaminated materials used in radioactive decontamination procedures.

9.35 In the preparation area, a section of worktop will be required for handling and drawing up radiopharmaceuticals. This should be shielded in lead/plywood laminate, with lead equivalent thickness 1 cm. Local worktop reinforcement will be necessary. The location of any windows in this room should be considered in relation to the location of the preparation area, although the use of windows is not advised for this area. Instead, roof lights may be appropriate, as described for the scanner room.

9.36 A lead-lined disposal bin containing a conventional sharps disposal container will be located on this worktop for the disposal of contaminated syringes and needles.

9.37 A sink will be installed for the disposal of radioactive substances and designated accordingly. In

addition, hand-washing facilities should be provided in this room or in an adjacent area. Drains should be designed, as described for radionuclide imaging suites.

9.38 General storage should be provided as required.

9.39 The handling and preparation area will be designated as a controlled area under the Ionising Radiations Regulations 1999, with appropriate shielding for the walls and doors.

9.40 Signage on doors together with appropriate warning signs should be provided at the entrance door.

Injection room and supporting facilities

9.41 The majority of patients are likely to be out-patients. Provision should also be made for in-patients and wheelchair users. Changing facilities will not generally be needed, but this should be assessed at project planning stage and may be shared with other adjacent modalities. Any metal objects such as watches and jewellery may display on the image. Provision should be made for their secure storage.

9.42 Some patients will require sedation, not arising particularly from the PET scanning procedure, but because of claustrophobia or anxiety induced by the scanner and scanning room.

9.43 Within the suite, the patient first goes into a preparation/injection area adjacent to the scanner room. The patient's height and weight are checked prior to scanning, to determine appropriate doses. Intravenous administration is then conducted.

9.44 One or two staff, together with the patient, will be present in the injection room at the time of administration. The administration of the radiopharmaceutical will usually be conducted with the patient lying supine on a couch.

9.45 Following injection, the patient typically lies still for an hour or more, to limit muscular uptake of FDG prior to scanning. The patient then walks through to the adjacent scanner room and transfers to the scanner table.

9.46 With the current generation of dedicated PET scanners, a typical scanning procedure may take one to one and a half hours, and a scanning procedure may be successive, for example a whole body scan followed by a localised diagnostic examination. The patient may take a WC break between scans. Following scanning, clinical staff will hold a brief discussion with the patient, regarding radiation risk procedures.

9.47 Provision should be made for the secure storage of drugs within the injection room. A small amount of general storage should also be provided in the form of base cupboards. Space for clinical hand-washing facilities should be provided. Space will also be required for a small preparation trolley.

9.48 Floor and wall finishes should be as for a radionuclide injection room.

9.49 Surroundings should be designed to be comfortable and relaxing.

Changing areas for staff

9.50 A separate area should be provided for staff working within the PET suite. This should be designed as described for the changing facilities for radionuclide imaging.

Patient toilet

9.51 A disabled access WC should be provided within the suite. The design of this WC will be as described for a radionuclide imaging suite.

10 X-ray mammographic imaging

BACKGROUND AND INTRODUCTION

10.1 Please also refer to NHS Estates guidance on facilities for cancer care services.

10.2 Mammography is an X-ray examination of the breast. It differs from ordinary general X-ray examinations in that the X-ray energies used are much lower. Because of this, the equipment used is very different from that used for general X-ray imaging and requires a separate installation or room. The technique is used both in routine medical screening for breast cancer in at-risk age groups and in symptomatic patients, that is, those with specific clinical symptoms that suggest the possibility of breast cancer.

10.3 Mammography is a highly sensitive technique for the detection of lesions, including the majority of malignant and benign types of breast cancer. It will probably continue to be used as the first line investigation of breast cancer. However, although highly sensitive, it is not specific in determining the type of lesion, so other modalities and biopsy techniques are used to refine the diagnosis. In particular, ultrasound and MRI are beginning to be used as complementary modalities.

10.4 The context in which the technique is applied will differ according to the category of patient – screening or symptomatic. Dedicated mammography screening centres will be provided at all levels of healthcare, organised on a regional basis and often supported by mobile vehicle services. Symptomatic services may be provided with other modalities as part of a breast care unit or within a diagnostic imaging and interventional radiology department.

10.5 Where symptomatic and screening functions are provided by the same unit, care should be taken to ensure that these patient groups are not mixed and remain separate, particularly before and after their examinations. The facilities required to support this objective are described below.

10.6 NHS Breast Screening Programme Guidelines provide information on the configuration and clinical standards for screening and symptomatic investigations.

10.7 Mammography equipment is smaller and more compact than standard X-ray equipment. This has an impact on the space required to install a unit, so mammography rooms tend to be much smaller in size than general X-ray rooms. Due to the sensitive nature of the examination, there is a great need for patient privacy and this is reflected in the overall design of the room.

Screening

10.8 The National Screening Programme is currently targeted on attempting to achieve earlier diagnosis of breast disorder in women aged between 50 and 64. However, under the NHS Plan, it is proposed to extend this to women aged 65 to 70, resulting in the screening of an additional 400,000 women. It is also proposed to use more extensive two-view mammography imaging techniques. Revised, increased staffing and facility arrangements will have to be planned to meet the new targets. Mammography was selected for this purpose after extensive reviews of available information on alternative early diagnostic or screening techniques.

10.9 Currently, 98 centres are configured to provide this service within the NHS. These are a mixture of fixed and mobile systems. Additional facilities may be required in support of the NHS plan.

10.10 Much of the national programme is dependent upon a two-phase approach.

10.11 A registry generates correspondence to alert patients to the availability of the service and to encourage their attendance. This service is intended to capture all women in the target age group and is supplemented by reports from general practitioners and others in primary health care.

10.12 First phase examinations, following initial patient contact may be carried out either in established screening centres or through the provision of mobile vehicle facilities, made available at public access points. The vans are equipped primarily to achieve mammography, including possibly processing and film viewing. They may also be equipped to permit a clinical examination of the breast by trained staff, as appropriate. Information on breast disease in the form of leaflets is also provided.

10.13 The design of the mobile service vehicles is beyond the scope of this current guidance.

10.14 The mobile vehicles are co-ordinated and supported by specialist screening centres and departments.

10.15 Exposed or, in some cases, developed films from mobile screening will be taken back to a DGH or another hospital for developing, reading and reporting by trained radiologists.

10.16 X-ray mammography examinations provide a special challenge in terms of film reading and reporting facilities. Radiologists and others trained in the reading of mammographic films have to deal with the large film numbers produced therefore high levels of skill and concentration are necessary to make accurate interpretations. Accordingly, the environment in which these interpretations are made requires care and design in order to maximise the visual acuity and characteristics of the viewing conditions, whilst avoiding distractions such as outside sound or interruption by colleagues.

10.17 Patients may be recalled for a mammography examination where there is doubt over the clinical findings or the technical quality of the first examination. These further examinations would be undertaken in the screening centre.

10.18 Where indicated by first phase clinical findings, women will be invited to attend second phase follow-up examinations and consultations, which may include the use of other modalities, for example biopsy, in a hospital care setting.

Symptomatic patients

10.19 Mammography imaging provision for symptomatic patients may be provided as part of a Diagnostic Imaging Department at secondary or tertiary level, in conjunction with other modalities such as ultrasound or MRI. Alternatively, mammography may be grouped with Ultrasound and specialist pathology and consulting facilities to form a Breast Care Unit. There are government guidelines, which state that symptomatic patients should receive a full diagnostic work-up within two weeks following a GP or consultant referral. Due to this requirement, there is greater emphasis on developing this aspect of the service.

10.20 In this regard, less urgent patients referred by their GP may be referred for mammography or, for urgent cases, may be referred for a triple assessment, which involves mammography, ultrasound and needle biopsy. Assessments for non-urgent and urgent cases are made by clinicians at the secondary or tertiary referral centre.

10.21 As stated above, initial examination or work-up at this level may be followed by a needle biopsy. This is conducted using stereotactic facilities and guided by equipment attached to a suitable X-ray mammography system. This may be undertaken under ultrasound imaging guidance instead of mammography X-ray control.

10.22 At present, a clinical trial is proceeding concerning the use of MRI as part of the triple assessment for the examination of at-risk women or those who have been singled out by the primary care level examination as having some indication of disease.

PATIENT JOURNEY

Screening

10.23 Patients who are attending examinations for screening will be routinely notified as described above and will either attend a mobile vehicle clinic or a specialist centre. If, following their examination, there are doubts as to the technical quality of the images or there are areas of clinical suspicion or further diagnosis is required, then the patient will be recalled and will usually attend a specialist centre for further examinations. In some cases, this may involve a triple assessment utilising both ultrasound and needle biopsy work as described for symptomatic patients. If the results are positive, the patient will be referred to the breast care team.

Symptomatic patients

10.24 Symptomatic patients will usually be referred for assessment by their GPs, following initial consultation. As stated above, depending on the referral indications and the considered urgency of the case, patients may be sent for a triple assessment which involves mammography and ultrasound, followed by image-guided biopsy work which may be undertaken under ultrasound or X-ray imaging control. In the case of triple assessments, patients will have an out-patient appointment booked within two weeks of initially presenting at their GP.

10.25 In respect of triple assessment clinics, patients will usually have an appointment with a consultant surgeon and the assessment will be undertaken whilst the patient attends this clinic. They will be given the results by the surgeon just after the completion of the diagnostic process.

10.26 Those patients who are considered less urgent by the surgeon will be referred for mammography and/or ultrasound at the earliest possible time available.

10.27 If, following an examination or triple assessment, the results are confirmed as being positive, the patient will be referred to the surgical team or an oncologist.

General aspects

10.28 On arrival for their examination, patients will be advised of the need to partially undress for the examination and will be provided with hospital gowns designed for this imaging procedure. Changing and sub-waiting facilities will be directly adjacent to the imaging or examination room. If patients are attending the same facilities for both screening and assessment following GP referral, then separate changing and waiting areas should be provided for each group of patients.

10.29 The patient will stand or sit directly in front of the machine or bucky during the examination. If required, patients will use a specific height-adjustable clinical chair, which should remain within the room. The design of some of these chairs may allow them to extend to become beds and the facility should be designed to allow for this feature.

Biopsy procedures

10.30 For biopsy procedures, specific patient consent should be obtained before the commencement of the procedure and a full explanation of the procedure should be undertaken by an appropriate member of the clinical team. The sample acquired at biopsy may need to be prepared and examined just after acquisition, particularly where this is concerned with a triple diagnostic assessment as described above. In some instances, a biopsy sample may be acquired following an examination and sent to pathology for preparation and review.

10.31 Where there is a requirement for immediate access to the sample, small pathology facilities should be located adjacent to the breast care unit.

10.32 Following insertion of the needle into the correct location, the patient may then wait in a separate private room with couch and chair in order that the mammography examination room can be used for the next patient. This space needs to be planned adjacent to the mammography X-ray room and the pathologist's room.

10.33 Following the procedure, the patient may be allowed to change, recover from the procedure and return to the clinic for further consultation with the surgeon.

LIST OF ACCOMMODATION FOR X-RAY MAMMOGRAPHY

10.34 Please refer to the plans in [Appendix 1](#) and to Figure 10.1.

10.35 A list of accommodation to support triple assessment and imaging mammography services would be as follows:

- mammography X-ray-imaging room(s) to an appropriate number for accommodation of the number of patients attending for types of the procedures clinically indicated. Biopsy procedures should not be undertaken in rooms dedicated for screening purposes;



Figure 10.1 Example of a floor-standing mammography unit. Image supplied Siemens Medical Solutions.

- dedicated processing and viewing areas;
- reporting room for the radiologist or other trained clinicians;
- an ultrasound suite as described above;
- pathologist preparation room serving more than one imaging room where biopsy work is undertaken;
- small private waiting room;
- separate sets of changing cubicles for both screening and symptomatic patients;
- sub-waiting areas for both screening and symptomatic patients, where operationally appropriate.

10.36 Shared accommodation with other modalities may include consultation room, counselling room and one recovery bay.

ROOM AND EQUIPMENT DESCRIPTIONS

10.37 The common elements in the design of mammography facilities in a hospital are described below.

Mammography suite used for the diagnosis of symptomatic patients

10.38 For routine mammography X-ray examinations, there is only a requirement to accommodate within the X-ray room itself the specially trained radiographer, a student radiographer and the patient. For radiation protection reasons, it is unlikely that others, such as relatives, would be granted access. However, the room should also allow for space for lesion aspiration or biopsy by the stereotactic mechanisms mentioned earlier. For this procedure, occupancy may increase to five persons and may include a radiologist, a nurse and, in some cases, a pathologist, in addition to the patient and radiographer.

10.39 For wheelchair patients, there may be a requirement to transfer them to the specific clinical chair mentioned above and space should be provided accordingly.

10.40 The majority of patients attending for mammography procedures will be ambulant, but wheelchair access should be provided. Modern equipment is readily adapted and adjusted to allow patients to be sitting or standing during the procedure. It is highly unlikely that the patients will attend for mammography on beds on trolleys. Contrast media will not be used in this type of examination.

10.41 As a significant proportion of patients will be over 65, the general design should allow for elderly patients

who may be infirm and have general mobility problems. The provision of grab rails and other design adaptations should be considered.

10.42 All mammography imaging examinations will probably include a lateral and superior/inferior view of each breast. In total, a minimum of four images will be acquired per examination. The X-ray equipment is designed to support this clinical objective.

10.43 Film/screen mammography utilises specially developed high-resolution film and cassettes, which are not usually used in general X-ray imaging.

10.44 The X-ray equipment will comprise:

- a single combined generator and control cabinet, which will vary in size according to manufacturer and sophistication but will usually be of a maximum size of 2m x 1m x 1m;
- a power distribution cabinet equipped with a basic on/off switch and an emergency off button;
- the X-ray machine is of floor- and column-mounted design. It is customary to bolt the unit to the floor to minimise vibration. The X-ray unit comprises a column, an X-ray tube and bucky unit in a rotatable U-arm arrangement. In its home position, the unit will have an approximate footprint area of about 1 m² and be 2.0 m high. The U-arm can be adjusted vertically to a maximum height of 2.5 m for superior/inferior views and can be rotated about a central pivot point up to +90/–90 degrees to allow lateral views of either breast.

In an examination, the breast will be compressed by the use of compression paddles, which are operated by small foot pedals located below the machine. The paddles are demountable and the manufacturer will usually provide a range of these devices to suit all patients;
- an X-ray control console and radiation protective screen. This may be provided as a fixed installation in a corner of the room or, alternatively, as a mobile screen in which a control panel may be added. In either arrangement the protective screen will be of maximum 1.5 m wide and 2 m high. An additional mobile screen should be provided to allow additional staff to be protected in the room during biopsy procedures.

10.45 Other fixtures and fittings will comprise hand-wash basin, cupboards for the storage of QA equipment and other peripherals associated with the mammography equipment, including compression paddles and an additional bucky for magnification views. Shielded vertical racking should be provided, preferably behind the protective screen, for mammography

cassettes, which are specifically allocated for this examination. Wall-mounted mammography viewing screens will be required. These are usually identical in terms of size and appearance but may differ in brightness characteristics and have some limited additional functionality. A minimum of one lead-lined protective coat should be provided particularly if biopsy procedures are undertaken.

10.46 Space should be allocated in the room for a computer RIS terminal, which should be located on a bench close to the main control console of the X-ray unit.

10.47 In general, oxygen and vacuum points should not be provided, but in all cases should be left to the discretion of the project team.

10.48 If required, provision should be made for storage and disposal of equipment associated with biopsy procedures. This may include a locked drugs cupboard, for local anaesthetics and sedatives, and sharps disposal bins. In addition, the room should be designed to allow for initial evaluation of the biopsy sample. This may take the form of an adjacent room.

10.49 A typical room area of 15 m² should be provided, with a maximum floor to ceiling height of 2.7 m. Mechanical supply and extract ventilation will be required. The provision of additional cooling should be considered according to the heat output characteristics of the equipment, workflow and maximum occupancy pressures.

10.50 The relative positioning of equipment and the doorway should be arranged to minimise the risk of accidental loss of privacy and maximise proximity and line of sight between the radiographer and the patient. The design should help minimise patient anxiety. An example is shown in [Appendix 1](#).

10.51 Typically, a free-standing room will incorporate a single doorway for use by staff and patients. In a triple assessment unit, the suite should be provided with interconnecting doors to the separate waiting and pathology rooms. Please refer to the plans in [Appendix 1](#).

10.52 Dimmable lighting should be provided to allow the use of X-ray viewers and to allow the bright lighting conditions necessary for maintenance of the equipment.

10.53 According to local design constraints, such as proximity of the processing area and the procedures used, a bench-mounted film marking unit may need to be provided.

Radiation protection

10.54 Whilst the X-rays are classified as penetrating, they are much more heavily attenuated by ordinary building materials than is the case in general X-ray imaging. This being the case, levels of shielding in terms of lead equivalence are substantially lower than encountered elsewhere. Typically, equivalence of approximately 0.5 mm of lead will be needed to generate levels of attenuation that will provide protection in accordance with the requirements of the Ionising Radiation Regulations 1999. This lead equivalence can be achieved by the use of the following alternative construction methods:

- single leaf of 100 mm medium density of concrete block work with conventional plaster finish;
- alternative building materials may also be appropriate such as Y-Tong.

10.55 The RPA should be consulted for further information in the above regard. It is likely that conventional floor construction will provide adequate construction radiation protection to adjoining spaces above and below.

10.56 It is likely that a relatively light but lead-lined door construction will be required, allowing for a lead equivalence matching the walls.

Changing facilities

10.57 As stated earlier, patients will need to change partially for their examination and changing cubicles should be provided within easy access of the mammography examination room and the sub-waiting area. As a general indication, two cubicles should be provided for each examination room. One of these cubicles should allow for disabled access and assisted changing.

Counselling room

10.58 An easily accessible counselling room should be provided, designated primarily for use with the mammography suite, but this facility may be shared with other modalities. The character of the room is described in Ancillary patient accommodation, [Chapter 15](#).

Sub-waiting area

10.59 The size of the sub-waiting area will depend on the policies utilised by the Trust and consideration should need to be given to allow partners and friends attending with the patient. As a guide, five to six spaces should be provided where relatives are allowed to accompany the patient. Where this not permitted, three to four spaces may be appropriate. At least one space should allow for a wheelchair user.

Needle biopsy work – additional facilities

10.60 As stated above, biopsy work should not be undertaken in rooms that are used for medical screening procedures, as this will have a drastic affect on overall throughput.

10.61 Mammography imaging rooms used for needle biopsy work should be made slightly larger, in order to accommodate the additional equipment used and additional persons present in the procedures. The additional equipment and facilities in the room may include the following:

- a digital spot mammography computer workstation, which displays mammographic images acquired during the biopsy procedure. An attachment is inserted into the X-ray mammography unit's cassette holder, the images are acquired digitally and data is transferred, directed to the workstation via a single cable;
- a pathologist will be present in the room during the procedure and will need to be protected from the X-ray source. For this reason, a mobile shield should be provided, in addition to those allowed for the radiographer undertaking the examination;
- following the collection of the biopsy sample, in some cases it will need to be prepared and reviewed almost immediately. A separate room containing some bench space and worktops should be provided to allow for basic histological and pathology analysis. The facilities to support these procedures are described in the NHS Estates guidance on 'Facilities for mortuary and post-mortem room services';
- in order to maintain throughput, the provision of a separate waiting room for the patient could be provided directly adjacent to the imaging mammography room. The patients will remain with the needles inserted until the whole of the procedure is complete. The pathologist may wish to further examine the patient and possibly obtain further sample for analysis. This room should be simple in design and contain a patient couch and other basic facilities. It should be located adjacent to the imaging and pathology rooms and have a separate entrance to the imaging room.

Facility implications for screening

10.62 As stated above, the mammography room itself will be accompanied by waiting facilities, particularly in the primary examination context. Here, examinations must be made quickly if the current capacity is to be sufficient to permit the screening of the majority of the female population in the appropriate age group. It is important to consider the provision of sufficient waiting facilities to ensure that as each patient's examination is

completed the team may move on to the next individual. It is likely that only one entrance to the mammography room will be required, as patients will be examined sequentially one after the other.

Digital mammography room design requirements

10.64 With the exception of biopsy work, virtually all mammography work undertaken in the UK is still carried out by traditional film/screen technologies. This is mainly due to the fact that image quality requirements in mammography are extremely high and the digital technologies have until now not quite reached the standards required. However, recent scientific evidence indicates that the technologies in this area are improving. One or two digital mammography units are starting to be procured, particularly by institutions in North America, where the majority of development work is taking place. It is likely that, as the technology matures over the next one to two years, it will gradually attract more interest from NHS trusts, with increasing numbers of hospitals acquiring this type of equipment. Because of this, all new mammography examination rooms should be designed to meet the requirements of digital mammography. The following changes may be seen as necessary to support this transition:

- a. the control area should be made larger in order to support the provision of additional computing equipment;
- b. all of the ancillary equipment supplied with the mammography unit will be present. Additional items associated with the digital equipment may require storage space;
- c. since the heat load in the room may be larger, air-conditioning should be included in the suite design, allowing for a switchable rate between six and ten air changes per hour;
- d. there will be less reliance on film processing, although the department may wish to maintain one processor for back-up purposes, particularly in the initial stages of use of the digital equipment.

10.65 In all other respects, the design of the suite will be similar to those units supported by conventional film processing as described in the sections above.

Special film processing needs

10.66 The image quality of X-ray mammographic images and the eventual radiation dose received by a patient will to a greater or lesser degree depend on the standards of film processing provided. As with the majority of X-ray examinations, but of particular importance in X-ray mammography, where the risk factors are considerably higher, there is a need to maximise image quality whilst minimising the radiation

doses involved. Good building design and facilities management can help achieve these overall aims.

10.67 In screening centres, there will need to be at least one dedicated film processor, possibly two, to avoid the possibility of a single point of failure. For symptomatic imaging units, at least one dedicated unit should be provided. Managers of the units should plan clinics to

maximise the activity of the developing and fixing chemicals, which can go stale if not used for long periods.

10.68 The environment where the processors are sited needs to be carefully controlled, in order to ensure that the films do not contain any static marks, which can mimic clinical features commonly seen on some mammograms. There must be close adherence to the specifications provided by the manufacturers.

11 Ultrasound imaging

BACKGROUND AND INTRODUCTION

11.1 Ultrasound imaging makes use of non-ionising as opposed to ionising radiation, in the form of relatively high frequency sound waves above 3.5 MHz and below about 20 MHz. The risks associated with the imaging procedures for both the operator and the patient are considered much smaller than ionising radiation investigations. The risks may also be smaller than with other non-ionising investigations such as MRI, where there is considerable current scientific debate over the effects of large low frequency (<1 Hz), and small radiofrequency magnetic fields.

11.2 With the exception of acoustic shielding, for patient privacy, there are no specific construction requirements associated with the use of ultrasound, as there are for X-ray or MRI installations. However, there are specific requirements with respect to filtered power supplies, electrical earthing and the general environment. Overall, the installation and technical built environment requirements are much simpler than those for other imaging modalities.

11.3 When siting an ultrasound department, care should be taken over its proximity to the fringe field of any MRI scanners, as fields as low as 0.5 Gauss may upset the functioning of imaging transducers. If it is proposed to site an ultrasound suite close to an MRI scanner, including those floors above and below the scanner, then a magnetic fringe field assessment should be undertaken.

11.4 The low risk, potentially high clinical benefit, coupled with relatively low cost and easy installation requirements, has resulted in ultrasound finding wide clinical acceptance for obstetric, gynaecological and paediatric scanning, and other clinical areas.

11.5 Due to its compactness, mobility and ease of installation, ultrasound equipment may typically be distributed widely across many hospital departments, such as ophthalmology, cardiology, obstetrics and gynaecology and A&E, in addition to the diagnostic imaging department.

11.6 Ultrasound has been substituted clinically for procedures and examinations that were once undertaken using either general X-ray or X-ray

fluoroscopy examinations. This substitution process is continuing and has been having a direct impact on the refurbishment of some diagnostic imaging departments. For example, the use of ultrasound now takes the place of X-ray fluoroscopic imaging of the lymph nodes and the majority of general abdominal X-ray examinations and liver biopsy procedures are now generally performed under ultrasound instead of X-ray imaging control.

11.7 In addition, Doppler ultrasound techniques, for measuring blood flow, have opened up a number of cardiac and vascular imaging possibilities. These techniques have developed rapidly over the last five years and are now well established in the majority of UK DGHs.

11.8 The speed, simplicity and minimal risk associated with ultrasound examination means that it may be used as the first step of a possible sequence of other diagnostic tests. With the increasingly fast development of ultrasound imaging technologies and techniques, the reliability of diagnosis associated with some procedures will probably improve. This will increase the frequency with which it is utilised.

11.9 Ultrasound units are typically mobile, in that they are not fixed into position on installation. The units are becoming gradually more capable as the number of clinical areas being investigated by the units is growing rapidly. As a result, many units are generally becoming larger in size, although less capable ultrasound units for specialised applications may be much smaller.

11.10 A typical ultrasound unit would consist of:

- a. an imaging and processing electronics unit complete with integral viewing monitor. In physical space terms, this is the main part of the equipment;
- b. a number of transducers or probes on trailing leads, which may be applied superficially to the patients skin or into a body cavity, to facilitate a variety of clinical procedures. They would be stored on the outside of the imaging and electronics unit described above;

- c. a separate or integral thermal printer for the instant production of single hard-copy images, displayed as soft-copy on the monitor screen;
- d. data cable links to a PACS or remote hard-copy laser printer. In order to effect this link, a secondary data capture unit may be provided, separate from the main unit;
- e. optionally, a medical video recorder for moving images, which would be integrated with the ultrasound trolley arrangement.

Procurement and replacement

11.11 Unlike other types of imaging equipment, the pace of development of ultrasound technologies and their construction is such that they require replacement every five to six years. This is opposed to seven to eight years for other types of diagnostic imaging equipment such as MRI and CT scanners. Trusts entering PFI or partnering agreements should allow for this at the beginning of the agreement and repayments for a five-year cycling programme should be factored into the payment structure.

Imaging approach

11.12 From the dynamic image, individual “stills” can be selected and saved as part of the record of the examination. Ultrasound machines may have an internal image hard disk storage capacity of 30 to 40 images to facilitate this operational requirement. The stills may be printed out using a thermal printer integral to the ultrasound machine, for incorporation into the patients’ notes. A more permanent record may be acquired by use of remote or local dry laser printers, or data may be saved to a full or mini PACS system. It is also possible to make video recordings of the examination, using a VCR mounted on the ultrasound machine, for subsequent review, or to save the images to a CD-ROM. These can be reviewed at a separate workstation close the ultrasound suite.

11.13 Hospital or departmental policy may vary with regards to the extent to which ultrasound images are filed with notes of the patient examination. For instance, the written notes may be regarded as the principal record, with ultrasound images only occasionally being included with these notes, or local policy may be always to retain at least one image with every note of an examination. Any video footage is usually kept for a short period for review or teaching purposes. Policy regarding image retention will determine the required extent of film, processing equipment and space.

CLINICAL AND OPERATIONAL OBJECTIVES

11.14 Ultrasound examination has a wide range of current clinical applications. Within a general ultrasound

suite, the predominant application may be, say, 30 to 35% obstetrics, followed by, in order of decreasing frequency, general abdominal work (for example liver or kidney examination), gynaecological work and miscellaneous vascular/paediatric/small body part work. An overview of clinical ultrasound investigations is listed below. As for other imaging examinations, there may be a requirement to use contrast enhancement media. Some specific instances of this are outlined below.

11.15 Ultrasound examination procedures are dynamic, producing a black-and-white or coloured moving image, which is viewed and assessed at the screen of the ultrasound machine itself. Coloured imaging may be used particularly to distinguish blood vessels and blood flow.

11.16 Listed below are some of the common procedures undertaken in an ultrasound suite. They are described in the [Glossary in Appendix 3](#):

- abdominal work;
- acute appendicitis;
- vascular and cardiac imaging;
- use in combination with other modalities and techniques – DVT;
- obstetrics and gynaecology;
- prostate and testicular scanning;
- interventional techniques including intra-luminal ultrasound;
- lymph node imaging in support of cancer;
- paediatric scanning;
- ultrasound mammography;
- ophthalmology;
- tumour imaging;
- musculoskeletal.

PATIENT JOURNEY

Referrals to a unit within a diagnostic imaging department

11.17 Patients may be referred for ultrasound examinations by:

- a. a GP;
- b. a referring clinician from another out-patient clinic;
- c. as a result of other diagnostic investigations;

- d. part of an assessment sequence in combination with other modalities such as MRI, X-ray mammography;
- e. referred from a ward as an in-patient.

11.18 The relative proportions of in-patients and out-patients will vary according to local demands and provision. As an indication, a general ultrasound unit that is part of a diagnostic imaging department may deal with approximately equal numbers of in-patients and out-patients during a “core” working day, possibly with dedicated out-patient sessions after 5 pm. In addition, urgent examinations for in-patients may also be handled outside of core hours.

Attending the examination

11.19 Imaging examinations may typically last, on average, 10 to 20 minutes. Paediatric examinations may take slightly longer. Interventional and biopsy procedures will take longer depending on complexity and may last up to one and a half hours.

11.20 Patients may attend for their appointments to the examination room either on foot, wheelchair, or by hospital trolley or bed. For some examinations, patients will be required to change into a hospital gown and appropriate facilities should be provided close to the examination room.

11.21 Patients are typically examined whilst lying on an examination couch, although some procedures, such as the examination of varicose veins, require the patient to be standing.

11.22 Scans may typically be undertaken by a radiographer, sometimes called a sonographer, or in some instances a general radiologist. For examinations outside the main diagnostic imaging department, examinations may be undertaken appropriately trained clinicians.

11.23 Particular consideration must be given to patient privacy, especially for some of the more personal examinations, particularly those that involve the use of body cavity transducers.

11.24 For some obstetric and gynaecological examinations, there may be requirement for patients to be scanned with full and empty bladders during the whole procedure. Disabled access WC facilities must be conveniently located.

11.25 For imaging examination patients, in contrast to those undergoing interventional procedures, patients will not usually receive GA, so recovery and preparation areas are not required. However, in some procedures, such as ultrasound guided amniocentesis tests, the patient may be administered some form of local anaesthesia. Occasionally, patients may require sedation, particularly paediatric patients.

11.26 Patients may be accompanied for their appointment by relatives and friends, who may be present in the room at the time of the examination and close to the examination table.

11.27 In some cases, and unlike most other types of diagnostic imaging examinations, the clinician will be at the side of the patient and may discuss clinical findings, during and immediately after the examination, particularly if these are considered relevant to the conduct of the procedure.

Exit from the examination

11.28 Following their examination, patients may return home, to the out-patient clinic, to the ward or, in some cases, may remain in the department for further examinations, consultations or counselling. Patients who have attended obstetric scanning appointments may wish to leave the department through a side exit and not through the main entrance to the department, particularly if this involves walking through crowded waiting areas.

11.29 Where out-patients have been examined by the use of body cavity imaging probes, a facility should be provided where patients can recover or recuperate before returning home.

Patient journey special case – interventional procedures

11.30 For interventional procedures, ultrasound imaging will be used to guide the insertion and placement of medical devices in the patient. A common example, found in most DGHs, is the use of ultrasound guided biopsy. In some cases, the ultrasound may be used to guide the placement of therapeutic substances such as cytotoxic drugs in patients with some types of cancers or metastases. However, this procedure is more commonly undertaken in tertiary referral centres.

11.31 Inpatients or out-patients may arrive at the unit as discussed above and will always be required to change into a hospital gown. Interventional procedures may be carried out under GA or, more commonly, particularly for biopsy procedures, using local anaesthetic, possibly mixed with light sedation. The duration of the procedure will be much longer than imaging examinations, as noted above. The anaesthesia may be induced either in a combined recovery/preparation area or within the actual ultrasound room itself.

11.32 Following the procedure, the patient will need to recover from the anaesthetic in a local recovery room, possibly followed by a transfer of the patient onto a ward or day case area for observation, before returning home.

LIST OF ACCOMMODATION AND LOCATION OF THE ULTRASOUND SUITE

11.33 Please refer to the plans in [Appendix 1](#).

11.34 The list of accommodation to provide a general ultrasound imaging service with interventional work, in a diagnostic imaging department, should be as follows:

- a. a number of general ultrasound imaging rooms or bays, in some instances as part of a suite to meet operational and local requirements. The number of rooms required will depend on the number of expected patients identified at the business planning stage and the length of working day. It should be based on an average of three patients per hour. Provision of ultrasound imaging facilities may be expected to increase and provision should be made within the design of the suite to allow for this expansion;
- b. at least one interventional ultrasound procedures room, again based on local requirements. It is expected that 15% of all ultrasound procedures undertaken will require some form of intervention. An average throughput would be one per hour. As an indication, one ultrasound room equipped for intervention work should be provided for every two imaging rooms. These rooms should be designed to allow for both imaging and interventional work;
- c. if the department undertakes obstetric and gynaecological examinations, at least one-third of the imaging rooms should allow for direct adjacent access to patient WC facilities. Ensuite WCs may be appropriate for interventional facilities, depending on patient age category. Further planning notes in this regard are described below;
- d. separate sub-waiting areas for ambulant, wheelchair, trolley and bed-bound patients with associated disabled access WC. This facility may be shared with other diagnostic imaging modalities, except for radionuclide imaging and PET;
- e. a counselling room directly adjacent to those rooms used for obstetric and gynaecology scanning;
- f. a recovery/preparation area for patients undergoing interventional procedures. These activity spaces may need to be provided separately, depending upon patient numbers;
- g. a superintendent sonographer's office;
- h. a small sub-reception area for patients. This would not be shared with a main department reception;
- j. changing cubicles. The number required will depend on the procedures undertaken, ratio of out-patients to in-patients and the changing method used;

k. an area for the storage of records pertinent to ultrasound examinations;

m. a clinical storage area to support interventional procedures.

11.35 The following accommodation will be required and may be shared with a wider diagnostic imaging department:

- a. radiologists' offices;
- b. storage of linen and general clinical supplies;
- c. disposal bays for waste materials;
- d. processing and review facilities including video review;
- e. staff rest, changing and WC facilities.

General planning issues

11.36 It is advisable that the ultrasound imaging rooms are grouped together within a department, as this will allow some sharing of facilities. Waiting areas for patients should not be located near those for radionuclide imaging and PET facilities for the reasons discussed above.

11.37 Where ultrasound is used in the support of detection of breast cancer in symptomatic patients, there may be a requirement to integrate ultrasound facilities with X-ray mammography and some limited pathology facilities. This is further described in NHS Estates guidance 'Facilities for cancer care services'.

11.38 Where it is proposed to undertake general ultrasound imaging outside the main diagnostic imaging department, the suite design will be as for a general ultrasound imaging room.

11.39 The clinical use of ultrasound is expanding rapidly and it is probable that this will continue into the near future. Therefore, where possible, additional space should be allocated to the suite of rooms for potential expansion. In some instances it may be appropriate to convert a general X-ray room into additional ultrasound facilities. This will depend on local and regional requirements for general X-ray examinations.

ROOM AND EQUIPMENT DESCRIPTIONS

General ultrasound imaging room

11.40 According to context, facilities for general ultrasound imaging should be provided in separate rooms with entrance doors, to ensure patient privacy and confidentiality. The doors to the rooms should not be fitted with automatic door closers, as this makes moving the ultrasound equipment in and out of the room

difficult. The size and general equipment for such rooms will be slightly larger than a typical examination room. In some contexts, for example a specialist paediatric care unit, it may be appropriate to carry out ultrasound imaging in adjacent bays opening onto a support space, with visual privacy provided by cubicle curtains. This approach is further described below.

11.41 Room decorations, finishes and general lighting should be standard clinical design. The room should be easy to clean, attractive and relaxing. It should be noted that the use of carpets is inappropriate.

11.42 Patients are typically examined whilst lying on an examination couch, which should be height-adjustable, and electrically powered (powered operation requires a conventional 13A supply). The couches should incorporate some form of battery back-up. Conventionally, and for right-handed clinicians, the operator and the ultrasound machine will be to the right and at the head of a patient lying supine on the couch. This may need to be reversed for left-handed operators and accommodation for this should be incorporated into the overall room design.

11.43 The examination equipment and couch need to be readily moved within the examination room, for ease of bed or trolley access, coupled with flexibility in undertaking the majority of the examinations. Doors or other access should be minimum one and a half leaf wide. If curtained access is provided, this should be the equivalent or possibly wider.

11.44 A clinical hand-wash basin should be provided within each examination room/cubicle, with elbow-action taps, as this is essential for handwashing between each consultation or examination.

11.45 In common with any diagnostic imaging facility, the provision of oxygen and vacuum services should be considered in each of the bays or rooms.

11.46 A twin standard wall-mounted X-ray film viewer is required within each ultrasound room, or, alternatively, shared between a suite of adjoining bays. This should still be provided if PACS or an imaging network has been installed. Worktop space should be provided to accommodate an RIS terminal and, in some cases, an additional computer workstation to view stored or current diagnostic images. The technology to combine the functions of RIS and image management into one workstation is currently available. In addition, a small amount of cupboard space should be set aside for QA Phantoms, test objects and other peripheral items or attachments that may be used in some examinations.

11.47 Low lighting conditions are required when viewing the images on the ultrasound unit's monitor and the X-ray viewers. Bright lighting conditions are needed when the ultrasound units are being repaired or

maintained. The lighting design should be similar in nature to that of an interventional fluoroscopy room, where a combination of independently operated spotlights and fluorescent lights are provided. Dimmer switches should be provided for the spotlights to allow for variable levels of illumination. Windows should be provided, if possible with a blackout or dim-out, to achieve proper viewing conditions for the ultrasound monitor, but this will prevent the opening of windows for natural ventilation.

11.48 Air-conditioning should be provided as a consequence of blackout blind provision, due to the high heat output of ultrasound machines and their sensitivity to high ambient temperatures. If the temperature in the room is above or near manufacturer's tolerances then the ultrasound units may be susceptible to longer periods of downtime and shortened replacement periods. The provision of air-conditioning will also maintain comfortable working conditions for the operators and patients during their examination.

11.49 The examination couch has a cloth cover, plus a paper roll cover that is changed between each examination. Thus, minor local linen storage within each examination room is required. The paper roll dispenser is wall-mounted at the foot of the examination couch. Dust from this paper can impede cooling fans/filters within the ultrasound equipment. Where possible, special low-dust papers should be used to fulfil this operational requirement.

11.50 Special gels and lubricants are used to couple the ultrasound probe to the patient to minimise the reflection of the sound wave from the patient's body. This has to be wiped from the patient at the end of the examination. As a result, ultrasound procedures generate large quantities of waste, for example linen requiring disposal bins, paper couch covers, disposable gloves. A large pedal-operated disposal bin will be required within each examination room/cubicle, and is likely to need to be emptied several times a day

11.51 As stated above, patient privacy and confidentiality, particularly during some types of examinations, is pivotal and the acoustic shielding in the walls of the ultrasound examination room or cubicle should be provided.

11.52 The sonographer or general radiologist may undertake the reporting of the examination just after its completion. Digital or analogue dictation facilities may need to be incorporated in the design of the room to enable this process.

Changing facilities

11.53 The requirement for changing facilities will vary according to the numbers of out-patients. In-patients are likely to arrive by trolley/bed or on foot in dressing

gowns. Changing cubicles should be provided on a minimum ratio of one cubicle for every two examination rooms, although this may have to be increased, depending on the method employed to store the patient's clothes. At least one of those provided should allow for disabled access and assisted changing. Alternatively, examination rooms could be sized and fitted out to allow changing within the room itself, but at some reduction to patient throughput.

Sub-waiting areas

11.54 As described for other modalities, separate sub-waiting provision should be made for patients who have changed into hospital gowns and for those who are waiting in their "outside clothes". Additional space for at least two beds should be provided for those attending as in-patients.

SPECIAL CASES

Paediatric ultrasound imaging

11.55 Ultrasound is a particularly appropriate imaging modality for the examination of children, because of speed, simplicity and avoidance of cumulative radiation exposure. In a specialist paediatric centre, the use of a number of adjacent curtained bays may be more appropriate for this category of patient, allowing economy of layout and the use of shared supporting facilities, such as storage and handwashing, to be achieved.

11.56 A disabled access WC should be provided ensuite to such a group of bays. This should include baby-changing facilities.

11.57 Consideration should be given to the provision of ceiling-suspended video monitors for entertainment and distraction during the examination. These should be cabled to a central video player incorporated within the design of the suite. Other devices to occupy the patients in the examination, such as mobiles and projector units, should also be considered.

Special requirements for obstetric and gynaecological ultrasound

11.58 Some types of obstetrics and gynaecological examination procedures require scanning of the patient twice. For the first scan the patient has a full bladder. The second takes place after the bladder has been emptied. This necessitates adjacent patient WC facilities, ideally ensuite, for some examination rooms.

11.59 The outcome of some obstetric examinations may be distressing for the patient and it is advised that these patients have the option to leave the ultrasound department via the use of a side door, rather than having to leave via waiting areas. Some members of this

group of patients may prefer to wait in a nearby counselling room before making their way home. The patient should be able to move to the counselling room without having to go through the waiting area.

11.60 Ultrasound facilities used for obstetric scanning should always be fitted with a door, for privacy reasons. If a window is fitted into the construction of the door, this should be fitted with a blind. The design of the room should always include some form of acoustic noise insulation.

Facilities for vascular ultrasound

11.61 Some procedures, such as examination of varicose veins in the lower legs, require the patient to be standing. The patient may be elevated by use of a step-up stand with handrail, to ease staff access to the lower leg area. The provision of this device should be incorporated into the design of the imaging room.

Interventional/intraluminal ultrasound special environment

11.62 Up to 15% of the procedures within a typical general ultrasound department are likely to be "interventional" or invasive. The proportion of interventional procedures undertaken using ultrasound will increase gradually as the techniques and imaging devices improve. In principle, the interventional procedures undertaken involve the use of ultrasound scanning to guide an invasive medical procedure. One example is the taking of a liver biopsy sample via a fine hollow needle introduced percutaneously (through the skin).

11.63 GA is not common in the majority of adult interventional ultrasound procedures, but local anaesthesia will probably be used, in combination with sedation. For paediatric patients, GA will almost certainly be required.

11.64 Radiology nursing staff, a sonographer and, possibly, an anaesthetist may assist the interventional radiologist during the procedure. Therefore five staff may be present. In addition, one or two other members of staff, students or researchers may need to be present for training purposes.

11.65 Standard sets or sterile packs of surgical instruments are pre-prepared elsewhere in the hospital or procured directly from manufacturers. Smaller and more specialised items will be laid up on trolleys before the examination. Most items used in the procedures are for single use only and will usually be thrown away after the procedure.

11.66 The ancillary accommodation that should be provided close to or adjacent to the interventional ultrasound room will comprise the spaces listed below:

- a. a recovery/preparation area;
- b. a small nurses' base area;
- c. sterile storage facilities for the sterile packs brought into the department and also for linen.

11.67 For centres undertaking large numbers of paediatric ultrasound procedures, it will be appropriate to provide ensuite WC and nappy changing facilities.

11.68 According to local hospital policy, the anaesthesia may be induced and the patient recovered in the ultrasound room before being returned to the ward. This may obviate the need for a separate recovery/preparation area, but will have a great impact on possible patient throughput.

11.69 The space allocated to the area and the provision of separate recovery and preparation rooms should be dependent on operational requirements and the number of patients who may need to receive some form of anaesthesia or recover following their procedure. There may be some scope for combining the recovery area with those provided for X-ray or MRI interventional procedures.

11.70 The interventional ultrasound room will be different in design and overall layout to the general ultrasound room described above. In general terms it will be larger and may include two separate entrance doorways. One of these should be large enough to accommodate patients on beds and trolleys.

11.71 The surfaces should allow for high standards of cleanliness and minimise the areas where dust and other particles can collect. Due to the heat generated by the ultrasound equipment, higher occupancy levels and the need to control infection, air conditioning should be provided to provide at least eight to ten air changes per hour. This room may also be appropriate for the examination of barrier-nursed patients, that is, those who are infectious or those that may be more

susceptible to infections. Clinical hand-washing facilities will be required possibly in the form of scrub-up sinks directly in the room.

11.72 General room lighting should be dimmable, similar to that in interventional X-ray fluoroscopy rooms, to provide clear viewing of the ultrasound images displayed on the integral machine monitors and of relevant X-ray films displayed on accompanying wall mounted X-ray viewers or PACS workstations. In addition, a procedures lamp should be provided, either floor- or ceiling-mounted design.

11.73 Full anaesthesia facilities should be provided, including piped oxygen and vacuum coupled with piped or bottled anaesthetic gases. Piped AGSS (anaesthetic gas scavenging system) should be provided where anaesthetics are used.

11.74 Reasonable worktop space should be provided, in combination with base units. As an indication, at least a 3 m run of worktop will be required for general clinical activities. In addition, further worktop space should be provided for RIS/PACS workstations. In order to avoid dust accumulation on the top of any wall cupboards provided, either sloping tops should be fitted or in-fill units extended and sealed against the ceiling.

11.75 Space should be provided for mobile equipment, including the patient procedure couch, a high specification mobile ultrasound machine, an anaesthesia/patient monitoring trolley, stainless steel operating theatre style stools, two or more lay-up trolleys, drip stands and disposal skips for the majority of types of clinical waste. For generalised room layouts together with equipment sizes please refer to example plans in [Appendix 1](#).

Special notes regarding earthing and power supply arrangements

11.76 Please refer to Engineering requirements, [Appendix 2](#).

12 Computed Tomography

BACKGROUND AND INTRODUCTION

12.1 CT scanning is a form of cross-sectional imaging that combines X-ray images from a number of different projections to form a single or multiple images. Instead of using film to detect the x-ray beam, a bank of solid state detectors is used to acquire the data from the different projections. Doses in some procedures can be relatively high when compared to other diagnostic imaging techniques.

12.2 The CT scanner is mainly used for scanning of emergency cases in the A&E department, in diagnosis and treatment of cancer, abdominal and neurological imaging, where formerly, X-rays on plain film would have been used. In order to meet the modern imaging requirements, multiple CT scanners may be procured and located appropriately for their use.

12.3 A dedicated suite of rooms is required for a CT scanner and X-ray shielding will be required for the scanner room. It is not uncommon to build a CT scanner suite in conjunction with an MRI unit, but this is not essential. However, economies of scale can be

achieved, especially in support areas, if this approach is adopted.

12.4 The main technical elements of a CT scanner are as follows:

- a CT scanner gantry;
- a couch which is located directly adjacent to the couch;
- a power distribution unit;
- a control console and associated computer.

12.5 CT technology is advancing rapidly. New units can acquire images spirally. Multi-slice or multi-detector units are now becoming available but these have enhanced protection and installation requirements.

Spiral CT scanning

12.6 The advantages of spiral CT scanners over conventional single slice units are:

- patient throughput is faster;



Figure 12.1 Example of a Spiral Computed Tomography unit installed into a hospital

- large volumes of anatomical information can be obtained quickly and easily;
- speed of scanning is increased, thus giving greater access to minimally invasive interventional techniques performed in the CT suite or examination room, such as image guided biopsy procedures;
- physiological and more detailed anatomical information can also be obtained, particularly when using contrast media in combination with spiral CT scanning.

12.7 To take advantage of the faster throughput available on the CT scanner, the design of the departments has to be considered carefully when considering patient flows through the units or departments. There needs to be considerable emphasis on the integration of patient support services, such as portering, patient transport, waiting spaces to achieve the potential benefits available.

12.8 The design of the room also needs to reflect the greater use of interventional procedures, particularly biopsy work conducted under imaging control. For example, the use of CT guided biopsy of the para-aortic lymph nodes can give a reliable diagnosis in suspected cases of lymphoma with virtually no morbidity. This is a great improvement of the types of procedures used previously. The design of the suites should therefore permit such procedures to be undertaken and this implies higher standards of infection control and ventilation and, for example, the incorporation of a small scrub-up area either within the scanning room or located in an adjacent area.

CLINICAL AND OPERATIONAL OBJECTIVES

Vascular applications

12.9 Although X-ray angiography, radionuclide imaging and, potentially, MRI will continue to be the major modalities in the investigation of cardiac and vascular disease, CT still has a role to play in determining some types of aortic disease particularly aortic aneurysms. The advent of multi-slice CT scanners and more powerful reconstruction computers with ever decreasing scan times may see the role of cardiac CT expanding outside the research and tertiary centres.

12.10 One type of CT unit, called the Imatron, is capable of imaging at speeds that make real time imaging of the heart possible. Currently, only one these units is installed in the UK, at the Royal Brompton Hospital.

12.11 The use of CT may replace a large proportion of radionuclide ventilation and perfusion of VQ scans in the detection of pulmonary embolism. This technique, particularly when performed on newer multi-slice

scanners with solid state detectors, has been shown to have greater sensitivity and specificity in cases where in the initial chest X-ray has shown signs of abnormality. In the UK, spiral CT may become regarded as the gold standard for the investigation of this disease, in preference to pulmonary angiography which has never become established due to difficulties in performing the investigation. In some circumstances, the use of spiral CT may supersede the use of radionuclide scanning in a number of patients. Therefore, the use of krypton instead of technetium aerosols may become more economical.

CT angiography

12.12 CT angiography is used to examine the patency and physiology of the vascular system. This is achieved by the use of imaging the patient whilst simultaneously administering, intravenously, a contrast agent. The administration of the contrast media is usually undertaken remotely by the radiographer from the control room and integrated into the scanning protocol.

12.13 Operational policies may require a nurse or radiographer to be in the examination room when the contrast media is administered, to ensure that it is not tissue and to comfort the patient during the procedure. In such instances, the staff member will need to leave the room relatively quickly before scanning is initiated and the ergonomics of any trailing leads should be considered.

12.14 A separate device needs to be incorporated into the CT scanner room for this procedure to be undertaken and its ergonomic positioning needs careful consideration. The use of this device is not exclusive to CT angiography and is used in a number of CT scanning procedures.

Surgical planning

12.15 Images from CT will be used to plan and assist a wide range of surgical procedures. The surgeon or a member of her/his team may wish to review the images acquired, or perform image processing, before undertaking the surgery. For throughput and access reasons, this should be carried out on a second cross-sectional workstation. This is further described below in both the CT and MRI sections.

Thoracic scanning

12.16 CT has emerged as one of the pre-eminent techniques for the imaging of thoracic pathologies.

12.17 Thoracic CT is used commonly where the findings from a chest X-ray are equivocal or normal and further diagnostic investigations are deemed appropriate. For example, subtle changes in perfusion and ventilation associated with small airways disease and diffuse

infiltrative lung disease are only shown on high-resolution CT scans. CT can also demonstrate primary tumours and metastases in the lung and mediastinum, where the chest X-ray has shown no abnormalities. In some of these cases, therefore, CT can have a large impact on the care and treatment received by the patient following the examination. However, due to the relatively large effective doses to the lungs, a number of departments utilise protocols which try discourage the use of CT examinations except where the scan can have a large clinical benefit and directly affect the treatment pathway.

12.18 A number of centres, particularly those outside the UK, have looked at the possibility of using low dose CT techniques on modern scanners for the screening of lung cancer in pre-defined categories of patients. The results are thus far equivocal, but if such measures were to be implemented within the UK, even on a localised pilot basis, this would increase the number of referrals for CT investigations. As such, departments may have to provide a second smaller unit to support the main system installed.

Radiotherapy treatment planning

12.19 CT may be regarded as essential when undertaking treatment planning for conformal and intensity modulated radiotherapy. The ability of CT to produce electron density maps depending on tissue type is necessary in planning therapies which maximise the dose to the tumour volume and minimise it to surrounding structures. The high spatial accuracy of CT also minimises inaccuracies in the planning and treatment process. The ability of spiral CT to acquire volumetric information means that this planning process can be undertaken in three dimensions. It is common to co-register CT and MRI data, in order to give better visualisation of the tumour being treated.

12.20 For a CT scanner to be used in radiotherapy treatment planning, the examination room must be equipped with two orthogonal lasers, aligned in the horizontal plane with the centre of the CT scanner. This is to ensure spatial accuracy in the PTV, from the acquisition of the anatomical information, planning simulation and eventual treatment. The lasers used are Class 2 (see MDA Guidance Notes on the safe use of lasers in medical and dental practice) devices and as such there are no particular hazards associated with their use, from a built environment perspective.

12.21 The CT examination room will also have to incorporate an additional mattress specifically designed for RTP purposes, together with appropriate accessories.

PATIENT JOURNEY

Patient information

12.22 Most patients will receive information about their prospective procedures from the person or organisation that refers them. However, it is unlikely that this will be either complete or sufficient for most patients' peace of mind. Therefore, the best way to bridge this gap must be considered. It is likely that by the time patients receive details of their appointments, more detailed information will be available. This information is likely to be in written form. Should additional, even more detailed, questions arise, it is recommended that facilities for a patient information centre should be used.

12.23 The patient information centre may contain interactive computer systems with CD-ROMs and DVDs which can be interrogated by both staff and patients to provide whatever extra information is required. Alternatively, this information may be available from the World Wide Web, so facilities to allow patients to gain access to the Internet may be provided, under appropriate supervision.

Appointments

12.24 Appointments can be made by the GP, or by the consultant responsible for the patient's care whilst as an inpatient or out-patient. The time lapse between making the appointment and the scan is necessarily governed by the clinical assessment of the urgency and the severity of the condition suspected.

Biopsy and interventional work

12.25 As a result of the CT scan, it is possible that further investigation of the patient's condition in the form of biopsy or other interventional work will be required. This will be necessary where the diagnostic CT or MRI scan, for example, has shown the presence of a suspected malignant tumour or metastases. The patient will then be referred again to CT, where the biopsy will be carried out under imaging control.

Referrals from CT

12.26 If the patient has a surgical or other type of implant, such as pacemaker, cerebral aneurysm clip, which is contradictory to MRI scanning, they will be referred for CT scan instead of MRI. Additional information should be provided to the patient before attending the MRI examination in respect of contraindications to this form of scanning.

ITU and A&E referrals

12.27 In the case of a referral from the ITU, an HDU or A&E, special attention will need to be paid to the amount of ancillary equipment that may accompany the

patient to the CT scanning unit. Such equipment could include patient ventilation devices, monitors and volumetrically controlled drug delivery systems. In the specific case of an ITU patient, given the level of monitoring equipment that would have to accompany the patient, it is likely the patient will be transferred to the CT scanner on their hospital bed. It is essential to note that any route taken by that patient should be sufficiently sized to facilitate this journey.

Patient preparation

12.28 Often, the patient will be visiting as an out-patient, possibly as part of a co-ordinated exercise involving attendance at a clinic or other procedures such as radiotherapy-simulation. Fifty per cent of patients will be in-patients brought to the CT suite from a ward.

12.29 For out-patients, initial attendance will be to a reception area, where the receptionist may also be responsible for ensuring a careful check on the patient's identity. The details of ascertaining the study to be performed will be dealt with through a referral form or as computerised information read by the radiographer. In some modern facilities, the study data can be downloaded automatically to the CT scanner itself, from a networked RIS system.

12.30 It is possible that children and adolescents may require a degree of immobilisation either in the form of full GA or by means of a lesser form of sedation. Facilities will therefore be required for administration of the above and for all engineering implications of the above, that is, piped medical gases and anaesthetic gas scavenging and appropriate colour corrected lighting, together with appropriate ventilation and power sources. The administration of the anaesthetic can be carried out in the CT scanner room or in a clinical preparation room immediately adjacent to the CT scanner. The choice of administration protocol will depend on the circumstances of the development.

12.31 Some patients may require physical immobilisation using such items as head restraints and restraining belts, thus rendering physically immobile a patient who may have been anaesthetised.

12.32 This is of particular importance when using CT for radiotherapy treatment planning, as even the slightest movement of the patient during the scan will degrade the spatial accuracy of the image produced. This makes it difficult to transfer the relevant spatial information from the CT to a treatment simulator or a linear accelerator.

The scanning process

12.33 Out-patients will be required to change from their outdoor clothes into suitable attire and provision of changing cubicles should be made. There is a requirement for a small sub-waiting area, immediately

outside the changing cubicle where patients can wait once changed, prior to their session in the scanner. This area may be shared with other diagnostic modalities such as MRI, for example. Patients who have changed into hospital gowns should not mix with patients who are still in outdoor attire.

12.34 The patient will be collected by one of the CT radiographers and escorted into the scanning room. Before the patient is moved onto the couch, the radiographer may need to attach an accessory, for example a head or arm support. The patient will then be transferred by the appropriate means onto the scanner table and positioned appropriately. Once the patient is in position, the clinical staff will retire to the control area, at which point a planning scan will be initiated. Once complete and reviewed, the clinical staff will proceed to set up the machinery for the diagnostic investigation. This may involve tilting the gantry by as much as $\pm 30^\circ$ about its central horizontal axis and sufficient space for the process should be allowed for in the scanner room. The patient on the scanning couch may be moved in and out of the centre of the CT gantry. Again, space must be made available for this and for unimpeded passage around the extremities of the couch. There is no requirement for the patient's couch to move vertically and horizontally in the same plane. Likewise, the scanner gantry will articulate to $\pm 30^\circ$ in the vertical plane only.

12.35 On completion of the examination, the patient will be assisted from the couch and escorted to the changing cubicle, where they will change and make their way back to the main reception area.

12.36 Diagnostic images could be transferred to a cross-sectional imaging workstation, which may be shared with the MRI scanner or other diagnostic modalities, using an ethernet network or via the use of CD-ROMs. In this instance, the images will be assessed and reviewed by a radiologist in a reporting room and further post processing work may be undertaken. The cross-sectional workstation may be used to transfer the images using a telemedical link to another location.

12.37 The workstation should be located in a small reporting area, separate from the control room, and facilities should be provided to allow the soft-copy reporting of images.

12.38 Alternatively, the diagnostic CT images may be laser printed and hard copy reported.

12.39 It is advantageous if the above process can be undertaken using a small LAN, possibly linked with WAN. The images can then be distributed digitally to the clinician within the hospital or via a telemedical link.

12.40 All CT suites will require an emergency controlled drugs cupboard, in case of contrast media reactions.

12.41 A warming cabinet for contrast media will be required.

12.42 The use of air as a contrast media is sometimes used in imaging examinations of the bowel or colon and usually requires an adjacent toilet to the CT examination room. Options are further described in the CT room descriptions chapter. This procedure is sometimes used as a replacement for barium enema procedures.

Interventional CT

12.43 For this specialist area, anaesthesia may be administered before transfer into the procedure room, if there is a dedicated anaesthetic/recovery area. Alternatively, the anaesthesia may be administered in the procedure room and the patient allowed to recover in this area or taken to a recovery area. However, this will have a deleterious effect on throughput. The method chosen will have an effect on the services, schedule of accommodation and sizes of rooms.

12.44 In order to protect the clinical staff who will be in the scanning room during the procedure, protective lead-lined coats will be worn, together with thyroid shields and lead glass spectacles. There is a considerable storage implication arising from use of these protective garments and it is usual for the store to be located outside the scanning room. Within the room, it is possible that there will be a requirement for a lead glass screen, which can be either floor-, wall- or ceiling-mounted, the latter in a similar manner to an operating theatre lamp.

12.45 If interventional CT is to be undertaken within the examination room, the finishes should utilise a Class 2 or 3 (see relevant HTM) ceiling design. The floors and walls should have no cracks or joins and should have a coved skirting, to avoid infection hazards from lodged substances.

12.46 The images obtained during an interventional procedure will usually be viewed using a trolley-mounted monitor, which will need to be sufficiently mobile to be visible to the consultant radiologist working at either side of the CT scanner during the procedure.

LIST OF ACCOMMODATION FOR CT

12.47 The following accommodation is considered necessary in addition to the CT examination or scanner room:

- a reception and main waiting area;
- a sub-waiting area for patients who have changed into smocks or gowns;

- a bed or trolley holding area. This may form part of the sub-waiting area as described above. Additionally, this may be shared with the MRI suite;
- changing cubicles, which should be compliant with the regulations of the Disability Discrimination Act 1995;
- preparation/recovery area for patients who are/have been anaesthetised; *
- clean and dirty utility rooms. These may be shared with other modalities;
- scrub-up areas, which will be needed if the radiologists are undertaking any form of interventional work in the CT scanner room. This area may be shared with the CT suite or located adjacent to both the MRI and CT suite. Space for this activity should be allocated even if it does not form part of the short-term operational requirements as it is likely that the building will house two or three generations of CT scanner and as such the OR may change over time;
- a scanner control room for control of the CT scanner; *
- a reporting room which may contain the cross sectional imaging workstation and other appropriate reporting facilities;
- a counselling room, which may be shared with other modalities that are particularly pertinent in Cancer Centres;
- a small porters' base to facilitate the moving of in-patients to and from the CT or CT/MRI suite. *

ROOM DESCRIPTIONS AND LOCATION OF CT

Siting requirements

12.48 If the CT scanner is located in diagnostic imaging department, it is essential that the CT department is so located to facilitate 24-hour access from A&E, with appropriate security considerations. This is likely to form the only referral pattern for CT outside of conventional or extended working hours, and the relationship of the two units is an important consideration.

12.49 If a high proportion of the CT scanner's use is for cancer patients, consideration should be given to provision of another dedicated CT scanner for this purpose within the oncology centre. This should be determined at the business planning stage for new Cancer Centres or units. This should not preclude its use for other purposes, although the use of such a scanner for A&E patients may prove difficult.

* Could be shared with MRI in a joint MRI/CT suite.

12.50 The provision of an additional separate CT scanner in A&E may be considered necessary in some larger departments and hospitals. However, a good relationship between the A&E department and the CT scanner located in the diagnostic imaging department should still exist, to allow for some additional capacity and provide back-up services when the A&E scanner is not working or undergoing maintenance.

12.51 There is requirement for a two-way link with the pathology department, for the transfer of biological specimens and other similar items. The control area or the CT scanner room itself could be the location for the link, which could take the form of a pneumatic tube.

12.52 It is advantageous for the CT scanner suite to be located adjacent to the MRI suite, although care should be taken in respect of magnetic field considerations. The modalities are similar in that they can acquire 2D cross-sectional diagnostic images. Imaging radiographers may be trained in both CT and MRI, so there will be some capacity for staff sharing, if a shared CT/MRI control room is provided. A single radiologist may be able to cover both a CT and MRI session, which may be helpful when members of staff are on annual leave.

12.53 If the CT scanner is to be sited on upper floors of a building, then one of the lifts with relatively good access either from a side or main entrance should be capable of lifting weights up to about 2 to 3 tonnes. The gantry of a CT scanner is delivered as a single unit and cannot be dismantled. If the lift is not large enough, or is unable to take the weight of the scanner gantry, then the equipment may have to be put in position by crane.

12.54 Unlike MRI systems, the overall size of CT scanner gantries is increasing, it is advisable to make the examination rooms slightly larger than required, particularly if this trend continues with the advent of combined radionuclide and CT imaging equipment. It is especially important not to “shrink wrap” the design of the room around a particular type or model of scanner.

12.55 Internal cooling may be required for the components located within the CT scanner gantry and the associated power distribution unit. Manufacturers of CT equipment may require a chilled water supply and an external chiller unit should be located somewhere close to the CT suite. In some cases this can be shared with the units provided with MRI scanner.

Ancillary accommodation

12.56 The scrub-up and sterilization facilities will be the same as for a minor operating theatre suite. The recovery room, which will also be used for the administering of anaesthetics, will need to be serviced with piped medical gases and gas scavenging. This will

be much smaller than an operating theatre recovery area, providing space for only two beds and a small nurse's station for observation purposes. Storage space should be provided to meet future requirements.

12.57 Sterilization of medical devices should be undertaken in an SSD, in accordance with hospital policies.

12.58 Clean and dirty utility rooms should be provided adjacent to the CT scanner room, particularly if interventional work is planned or undertaken, and this may be shared with the MRI suite if appropriately located.

12.59 If treatment of children and adolescents is anticipated, a dedicated activity area may be required, to occupy the children whilst waiting for their scan and as a facility for siblings whilst scanning is undertaken. This could take the form of a small annex in the main waiting area, or may be contained in the main waiting area itself. In this case, good visibility from the reception area to the play area is essential.

Reception

12.60 The reception serves both as a reception for patients and as the point at which the details of newly arrived patients are checked and verified. Where the CT scanner is located in a main diagnostic imaging department, the main reception area could be shared with other modalities or, alternatively, if the CT scanner forms part of a separate combined MRI/CT department, the reception area should be provided and sized accordingly. A description of a typical reception area is described in NHS Estates guidance HBN 40 vol 1 ‘Common activity spaces’.

12.61 In a combined MRI/CT satellite facility, the reception counter may have space for one or two reception staff, depending upon the number of patients who may attend for CT examinations. The CT reception counter should be located and designed so that its presence is obvious to patients and escorts when entering the suite.

Patient sub-waiting area

12.62 A sub-waiting area is required so that small numbers of patients and escorts can wait before, during and after a CT examination, as appropriate. The sub-waiting area also provides an alternative to waiting in a patient preparation room.

12.63 Patients may be fully dressed, partially dressed or wearing only procedures gowns. Privacy from the main waiting area should be considered.

12.64 The sub-waiting area should be comfortably furnished with different types of seating, so that the

needs of the elderly and children are also addressed. This area should provide occasional tables for reading material and include a wall-mounted panel where information can be displayed. Access to refreshments should be provided.

12.65 The sub-waiting area should be adjacent to the patient preparation rooms, close to the interviewing room and have easy access from the main waiting area and to the CT examination room.

12.66 Chairs in the patient sub-waiting areas should be covered with non-absorbent materials that are easily and cleaned. This is in order to deal with any patients who are incontinent, vomiting and possibly receiving intravenously administered therapies.

12.67 Space should be provided for out-patients arriving in wheelchairs within the sub-waiting area.

Bed/trolley/wheelchair waiting area

12.68 This waiting area is required for in-patients arriving by assisted transport. The bed/trolley/wheelchair area should be located within the CT suite. The area should be separate from other waiting areas and provide space for patients to wait before being transferred to the CT trolley. Circulation space will be required for nurses and others attending the patient and for additional equipment being used by the patient. In combined MRI/CT suites, care should be taken not to confuse the trolleys designated for MRI and CT use.

Patient toilets

12.69 WC facilities for patients should be provided close to the main waiting area and sub-waiting area. At least one WC close to each area should have access for a wheelchair, space for assistance to be given, and grab rails.

12.70 In some instances the CT room is used for examination of the colon and part of this examination is achieved by distending the organ by the use of air. In addition, contrast media may be administered during this imaging procedure. Following or during this examination the patient will need to visit the WC and therefore the provision of additional facilities should be considered. Project teams should carefully consider the position and provision of this WC in relation to the CT scanner room.

Changing cubicles

12.71 A minimum of two dedicated changing rooms for the CT scanner should be provided. Ideally these should not be shared with those provided for other modalities. Lockers could be provided for the storage of patients' valuables, or the shopping basket approach described above may be appropriate.

Anaesthetising (preparation)/recovery area

12.72 The anaesthetic/recovery bay is used for the induction of and recovery from anaesthesia for patients requiring a general or local anaesthetic, or sedation. There may be two or more of these bays. Each bay may be used by the patient, either on a trolley or a bed. Space for up to four staff members working in and around the patient is required, together with a small staff or nurses' base.

12.73 Patients from A&E could wait for a short time in this area while the scanning room is prepared for their examination, if this is deemed clinically appropriate.

12.74 A two-position anaesthetic/recovery bay is normally adequate, on the assumption that the small number of patients who may require anaesthesia/sedation will be interspersed with patients who do not require it. If it is intended to group in one session all patients requiring general anaesthetic, then project teams should give consideration to patient flow issues and the adequacy of a two-position bay. The patient may arrive on a bed, a trolley or in some cases, particularly where interventional procedures are undertaken, s/he may be admitted on a day case basis.

12.75 If this facility may be shared with the MRI examination room, the provision of a two bay facility may not be adequate.

12.76 In specialist paediatric institutions, virtually all patients will require sedation or general anaesthesia before their examination, making the provision of separate anaesthetic and recovery areas appropriate. A member of the paediatric nursing team and, possibly, a relative may accompany a child patient.

12.77 The patient is anaesthetised/sedated on the bed or trolley on which they arrive, and is transferred to the CT room using this trolley.

12.78 The bed or trolley can be parked in the anaesthesia/recovery area bay until the patient is returned. The patient will be returned to the bed or trolley for recovery and subsequent exit from the CT suite to complete pre-discharge recovery elsewhere in the hospital.

Design considerations

12.79 Privacy and an environment with minimal disturbance are important. The bay should have walls on three sides and cubicle curtains to the opening and between each position.

12.80 There should be:

- adequate space around the patient on a bed or a trolley in each position for staff to move and work and for equipment to be moved and parked while in use;
- a clinical hand-wash basin, paper towel and soap dispensers;
- a sink unit;
- a worktop for laying out instruments;
- storage units for drugs, sterile supplies and infusion fluids;
- a lockable cupboard for the temporary storage of controlled drugs issued to an anaesthetist for a session;
- a lockable refrigerated storage for drugs.

12.81 The anaesthesia/recovery bay should be close to the CT scanner room so that the anaesthetist can quickly and conveniently move between the two spaces.

Clean and dirty utilities

12.82 Refer to HBN 26, 'Operating department' and HBN 40, Vol 3 'Common activity spaces', Staff areas. These should be shared with other modalities.

CT scanner room

12.83 The CT scanner or examination room will accommodate the CT scanning unit and the associated patient couch, which will be integrated with the CT scanning gantry and limited storage facilities. The patient may be accompanied by a carer and up to five staff members, who will remain until the examination is ready to begin. The latter is particularly true for patients attending from A&E or possibly HDU/ITU.

12.84 The CT scanner should be aligned diagonally to the patient observation window so that the radiographer is able to see the entire length of the CT scanner together with the centre of the scanner gantry. This arrangement is described in the plans within Appendix 1.

12.85 There should be sufficient space for the transfer of a patient from a bed, trolley or wheelchair to the scanner couch. Usually, a radiographer and, possibly, an assisting nurse will accompany the patient. The use of a patient slide or a hoist may be required to transfer the patient from the trolley to the CT examination couch.

12.86 Where equipment failure occurs, it may be necessary for a patient to be moved quickly from the scanner and this should be considered in design terms. Resuscitation of the patient can be undertaken in the

examination room following respiratory or cardiac arrest and therefore the provision of resuscitation equipment and a cardiac alarm should be provided.

Scrub sinks

12.87 Please refer to HBN 26, 'Operating department'. These should be provided in the CT scanner room, particularly if the institution is considering undertaking interventional radiology procedures,

Design considerations

12.88 The patient should be presented with an environment that is comfortable and reassuring, promoting both patient comfort and co-operation, reducing stress to patient and staff. Care should be taken with the interior design of the examination room in order to provide a calm, reassuring environment for anxious patients. Designers should not simply provide spaces that satisfy functional requirements: they should aim to create an aesthetically attractive environment, which inspires confidence in the service being offered and helps to minimise anxiety.

12.89 Doors should provide radiation protection similar to that provided for the walls ceiling or floor in terms of lead equivalent values. This may be between 2.5 and 4mm of lead equivalent construction at 150kV, but exact levels should be agreed with the RPA. The door must open into the room, providing shielding for people who accidentally enter the room during scanning.

12.90 A separate entrance between the scanner room and control room for members of staff is essential. The entrance doors must be visible from the control area so members of staff can see anyone entering the examination room. Patient entrance doors must allow access for trolley, wheelchair or persons on King's Fund beds supplemented with patient monitoring equipment and drip stands.

12.91 Replacement access should be available to accommodate the gantry of the largest CT scanner currently available. Consideration should also be given to floor-loading issues.

12.92 In addition the following should apply for the design of the CT examination room:

- provide for all clinical procedures. This may include a requirement for infection control and physiological monitoring (for example ECG and pulse oximetry);
- provide for clinical hand-washing;
- finishes should be suitable for regular cleaning and the easy removal of spillages and accidents. Floors should be seamless with coved skirtings;

- anti-electrostatic floors should be provided, as anaesthetics and sensitive electronic equipment will be used in the room together;
- adequate storage space is required for quality assurance equipment, contrast media used in the examinations, sundry clinical items including blankets, and immobilisation devices including those used to support the patient during the examination, such as additional head supports;
- worktops are needed for routine tasks, assembling equipment, administration tasks and supporting bench-mounted equipment, such as a bench mounted unit for warming contrast media prior to use;
- where appropriate adaptations to the room should be made for high volumes of paediatric patients;
- stacking chairs may be required for occasional use;
- for CT fluoroscopy work, a floor-mounted trolley will need to be incorporated into the design and this may need to be placed either side of the patient couch to facilitate left- and right-handed operators. In addition, the CT scanner may operated by a foot switch and care is required over the positioning of this device to ensure operational requirements are met, whilst reducing hazards from trailing leads;
- where the CT scanner is used for planning purposes, laser alignment devices for RTP will need to be incorporated in the design of the room, with the generator located outside the room, possibly in the control area;
- medical gases such as wall-mounted piped oxygen and vacuum should be provided;
- a wall-mounted emergency off switch may need to be provided, depending on the provision of these on the actual scanner gantry;
- variable-level lighting will be required, provided by a mixture of fluorescent lights and spotlights particularly if interventional procedures are to be undertaken on the CT scanner room. Low levels of lighting are required for viewing monitors and laser positioning lights. High levels of lighting are needed for maintenance procedures;
- scanner-control room intercom (normally integral to the scanner);
- a separate technical room is not required for modern CT scanners, as the majority of electronics are now incorporated in the scanner's gantry. Additional space should be allocated within the examination room for a

power distribution unit and, possibly, a small computer;

- a coloured CCTV monitor behind the CT scanner;
- floor- or ceiling-mounted (articulating arm) contrast media injector cabled to the CT scanner. In some instances the radiographer will need to leave the room quickly, just before the administration of contrast media, to ensure that the contrast media does not tissue. Hazards from trailing leads should be avoided.

Design considerations where interventional work will be undertaken

12.93 These are as follows:

- a scrub sink should be provided;
- medical gases such as oxygen and vacuum should be provided;
- anaesthetics may be required for undertaking interventional procedures or when scanning seriously ill patients. Ceiling-mounted pendants could be provided to allow access to these services;
- air-conditioning should be provided, with a minimum of ten air changes per hour;
- dimmable lighting within the examination room, to allow the operator to view the mobile monitors;
- ceiling- or floor-mounted special procedures lamp;
- the use of a sealed ceiling may be appropriate to control levels of infection;
- bench space may need to be provided for a pathologist to prepare a specimen for further analysis in the CT room following the completion of a biopsy;
- anaesthetic gases and scavenging could be provided by the use of piped or trolley-mounted services.

Planning relationships

12.94 The scanner room should be adjacent to the control room; close to the patient preparation rooms, the sub-waiting area, and the anaesthesia/recovery bay a conveniently located in relation to the reporting room. A dedicated toilet may need to be located directly from the scanner room depending on the number of examinations of the colon undertaken by the centre.

Control room

12.95 The control room is used to control and monitor to scanning process taking place in the CT scanner room. Activities will include:

- operating the scanning equipment;

- monitoring the images on a VDU;
- communicating with the patient via an intercom;
- observing the patient through the shielded observation window and/or CCTV;
- performing tasks related to the images being obtained, such as archiving onto a storage device or controlling the processing of hard-copy images;
- carrying out administrative tasks. Part of this administration will be undertaken using an RIS terminal, although in some instances the RIS may be directly interfaced with the control workstation.

Design considerations

12.96 The occupancy pressure involved will vary from patient to patient and the treatment they are receiving. Up to seven members of staff may be present at any one time, including radiographers, radiologists, visiting oncologists and surgeons, escorting nurses and the anaesthetics team. In teaching institutions, trainees may also be present in the control room to observe some procedures.

12.97 The following design considerations are relevant for the CT control room:

- access to the CT scanner room should be controlled and/or authorised from the control room;
- doors opening into the CT scanning room should be equipped with two stage warning signs. They must open into the room and incorporate lead shielding to the level of the walls enclosing the scanner room;
- door to the control area from the main staff or public space should be lockable, although access will be required for 24 hours in most instances for A&E cases;
- good observation of the patient being scanned from the control desk or workstation must be achieved through the lead glass observation window. The patient may also be observed by the use of CCTV;
- a wall-mounted triple X-ray viewer is required for viewing films. This may still be required even if the hospital has moved to a full digital approach for the storage and handling of radiological images;
- a worktop where staff can sit to read and write should be provided adjacent to the console;
- a fireproof storage area for patient records and magneto optical disks is required. This could be located under a bench;
- locked storage area for manuals, which will need to be accessed by visiting engineers and scientists. This could be located within the examination room if space is limited;
- shelving for educational materials;
- a dry laser may need to be incorporated in this space for the printing of CT images, but this will depend on whether this area is adjacent to a processing area;
- lead coats and other protective clothing, which will be needed during interventional procedures or when examining seriously ill patients, could be stored in the control area or just outside the examination room. These clothes can be heavy and consideration should be given to wall loading.

Service considerations

12.98 Mechanical or air conditioning should be provided to maintain comfortable working conditions.

12.99 Natural daylight would be beneficial, although the lighting will need to be dimmable between high and low-levels for viewing monitors and undertaking maintenance.

12.100 To observe patients, a CCTV monitor will be needed in the control room.

12.101 An emergency stop switch will be required in the scanner room.

Planning relationships

12.102 One control room can serve more than one scanner, and may perhaps be appropriate for serving, for example, two CTs and an additional MRI scanner. There should be sufficient room for the separate consoles, but other facilities can be shared.

Reporting and image review room

12.103 This is described under [the chapter on MRI](#).

Counselling room

12.104 Where possible a counselling room should be provided within the CT suite, particularly in relation to cancer care. This could be shared with other modalities. A description of this room is provided in Ancillary patient accommodation, [Chapter 15](#).

13 Magnetic Resonance Imaging

BACKGROUND AND INTRODUCTION

13.1 The imaging process of MRI depends essentially on placing the whole body, or a selected body part into a very intense standing magnetic field. This field, which in modern application will have a magnetic field strength between 0.1 and 4 Tesla, has the effect of slightly realigning the axes of spin for chemical species present in the tissue or body to be imaged. The most prolific chemical species is hydrogen and, therefore, the proton, so that the huge majority of imaging focuses on a change in energy for this particular species. Much of the hydrogen in the human body exists as water. The extent to which the energy of the water is modified is directly related to the magnetic field strength. This has led to a recent push from 0.5T through 1.0T and most recently toward 1.5T machines being used in diagnostic imaging departments. The movement toward greater magnetic field strengths has important implications for the built environment. These high strength machines are heavier, having increased electrical requirements, and may require greater magnetic shielding than their lesser counterparts.

13.2 The powerful magnetic field described in the outline above does not itself generate the signals that are responsible for imaging. Instead, these are produced by subjecting the body or volume of tissue within the strong magnetic field to an additional field, in the form of radio frequency radiations. This second field disturbs the spin axis or direction established by the primary magnetic field. As the proton or other species recovers

from this RF induced disturbance, radio frequency energy is released and it is this signal that is used to generate the images. The magnitude of this signal is very small, implying that the receiver needs to be very sensitive and extremely well protected against other radio signals, such as those used for communication and entertainment. For this reason, virtually all MRI systems will be fully enclosed by a Faraday cage, which is itself tied electrically to earth. This special cage is normally referred to simply as an RF cage. In addition to keeping out unwanted signals, the cage also prevents the signal generated by the MRI from interfering with equipment elsewhere, although this is a lesser challenge.

13.3 Clearly, the above still leaves the challenge of determining where the signal arises within the patient. Without information on the origin of the signal, only chemical analysis would be possible and no image can be produced. In order to overcome this challenge, the MRI machine also incorporates gradient coils. These modify the otherwise homogeneous magnetic field present in the imaging volume of the MRI, so as to slightly shift the frequency of radiation emitted from the proton species. This slight shift can then be decoded to show where the emitting atom or species is located within the body. Hence, MRI has a full three-dimensional imaging capability. In environmental terms, the presence of these gradient coils is a significant challenge because they are very powerful electrical devices and require auxiliary services such as high load power supplies, mechanical ventilation and air conditioning, both within

TABLE 13.1 MINIMUM SITING DISTANCES FOR MINIMISING THE INTERFERE OF THE UNIFORMITY OF THE MAIN MAGNETIC FIELD

Structure/Item	Minimum distance (m) for a shielded magnet	Minimum distance for unshielded magnet
Steel floor reinforcement	Shimming possible	1.1
Steel girders, highly reinforced columns, air-conditioning ducts	Shimming possible up to a density of 30 kg/m ³	5.5
Power lines and transformers	10	11.0
Cars, small vehicles	6–9	13.0
Lifts and large vehicles	8–11	16.0
Electric trains	40	50.0

the MRI imaging room itself and in the associating engineering or machine rooms. In recent years, these gradient coils have, like the MRI machines in general, become much more powerful and have a much higher standard of performance. This means that the engineering challenge and the requirement to successfully accommodate the engineering elements within the built environment continue to rise, though the equipment itself is getting smaller.

Signal detection

13.4 As stated above, a very sensitive radio frequency coil is used to receive the small signal generated by the patient's tissue. Such are the specialist requirements and demands of clinical work that, although a whole body receiver coil will be incorporated into almost all MRI scanners, there will also be a need for body part specific coils. These will include special coils for the imaging of joints, but in the context of cancer, modern flexible coils are likely to be employed. These coils may be brought into direct contact with the body surface and are exceptionally powerful in terms of tumour detection and imaging. The coil portfolio of a modern MRI may run to as many as a dozen or more devices and thus the room must be designed in order to accommodate their ready storage and preparation for use.

Static magnetic field production

13.5 The very large standing magnetic field, mentioned at the head of this description, is difficult to generate. Essentially there are three means, which are described in the following subsections.

Permanent magnets

13.6 For low power scanners, a very large permanent iron magnet may be used. Whole body scanners weigh between 1 and 30 tonnes and may have significant implications in structural terms, but since no energy is consumed in maintaining the magnetic field, the operating overheads can be usefully reduced. In addition, small body part scanners are available for imaging limbs and joints. These have much simpler installation requirements as described below.

13.7 Although the permanent magnets have no direct cooling requirements, the gradient coils and other devices associated with the magnets may require cooling. This is further outlined below.

Resistive magnets

13.8 Resistive or electromagnetic systems represent the second option. These are powered directly by three-phase supply but have a very heavy electrical consumption, normally in the range 30 to 50 kilowatts continuously. The resistive magnet has the advantage that the field can be removed by simply interrupting the

power supply to the generating coil. Most of these systems incorporate the use of an iron core and may weigh up 100 tonnes, therefore having considerable installation requirements. In a resistive magnet, cooling of the magnetic field coils is effected by the use of a closed chilled water supply.

Cryogenic magnets

13.9 Thirdly, and by far the most common, are superconducting electromagnets, which are maintained at very low temperatures by cryogenic cooling. These are usually referred to as cryogenic magnets and operate at temperatures generated by liquid helium enclosed within a very large Dewar flask of volume between 750 and 2000 litres. The magnetic coil enclosed within this Dewar flask will be capable of superconductivity. In consequence, after the very large initial current, of between 150 A and 400 A, has been inserted during the commissioning process, the system will remain intensely magnetic with super conductive current flow. Should it be necessary to remove the magnetic field then the super conductive current must itself be interrupted.

13.10 Cryogenic MRI scanners have sophisticated valves to permit the addition of helium, but they also have quenching or discharge valves. The latter valves are connected by a large diameter tube to a safe point (see Medical Devices Directorate (MDD) guidance notes) outside the building from which huge volumes of helium, in a ratio of about 5000:1 to the liquid volume, may be discharged quickly. Such processes are not routine. They are only applied in the event of incident or accident. The only exception would be during decommissioning of the magnet at the end of its useful life. For cryogenic systems, the machine will incorporate one or more cold-heads, which are concerned with minimising the consumption of helium through thermal losses. These cold-heads will be closed circuit and incorporate a compressor. Whilst small interruptions to the power supply of the MRI as a whole and the cold-head in particular may be tolerated, should the magnet temperature rise significantly, gas loss will occur. Not only does this have significant implications in cost terms, but also restoring magnet operation may be delayed. Thus there are a number of important electrical engineering parameters in this area. These are outlined later in this chapter.

Gradient coils

13.11 Water-cooling may be used for gradient coils, although some other designs are simply air-cooled. Water supply, whether for cooling or for use at a sink or wash-hand basin is a particular challenge for MRI, because, like all other services and connections, the supply must enter the MRI imaging room through the RF cage. As such an entry will inevitably create an aperture through which radio waves could proceed, a wave-

guide or blocking structure must always be employed. These items are frequently integrated into a so-called RF pad. All MRI installations will contain at least one and, more commonly, two such devices.

Trends in MRI imaging

13.12 In MRI there appear to be three distinct classes of MRI scanners being marketed and sold by the manufacturers and suppliers. These are as follows:

- a. specialised MRI scanners, which have been designed for niche applications, such as orthopaedics;
- b. whole body imaging systems, where the technology has improved to allow for higher field strength magnets at lower cost. Newer machines, which are currently being made available in the USA have field strengths as high as 3.0 T and weigh as much as 15 tonnes. Their availability and use in the UK for general clinical use would conflict with current MDA Guidelines on the Use of Magnetic Resonance Imaging;

- c. specialised cryogenic and non-cryogenic electromagnets, which are designed for interventional and imaging work.

CLINICAL AND OPERATIONAL OBJECTIVES

13.13 MRI has entered common use as part of the standard equipment portfolio over the last 10 to 15 years. The modality is of particular interest in the following clinical areas.

Cancer imaging and diagnosis – general case

13.14 MRI is useful in the diagnosis and staging of cancer, owing to the ability of the technique to selectively image soft tissues, including both benign and malignant tumours, at potentially high resolution. In some instances, disease detection and imaging sensitivity of MRI may exceed that of CT, though this is not universally the case. In the detection of masses, the scanner is essentially being used to generate cross sectional images of the body, which may be reformatted to other projections, in pursuit of resolving issues concerning the presence or absence of masses.

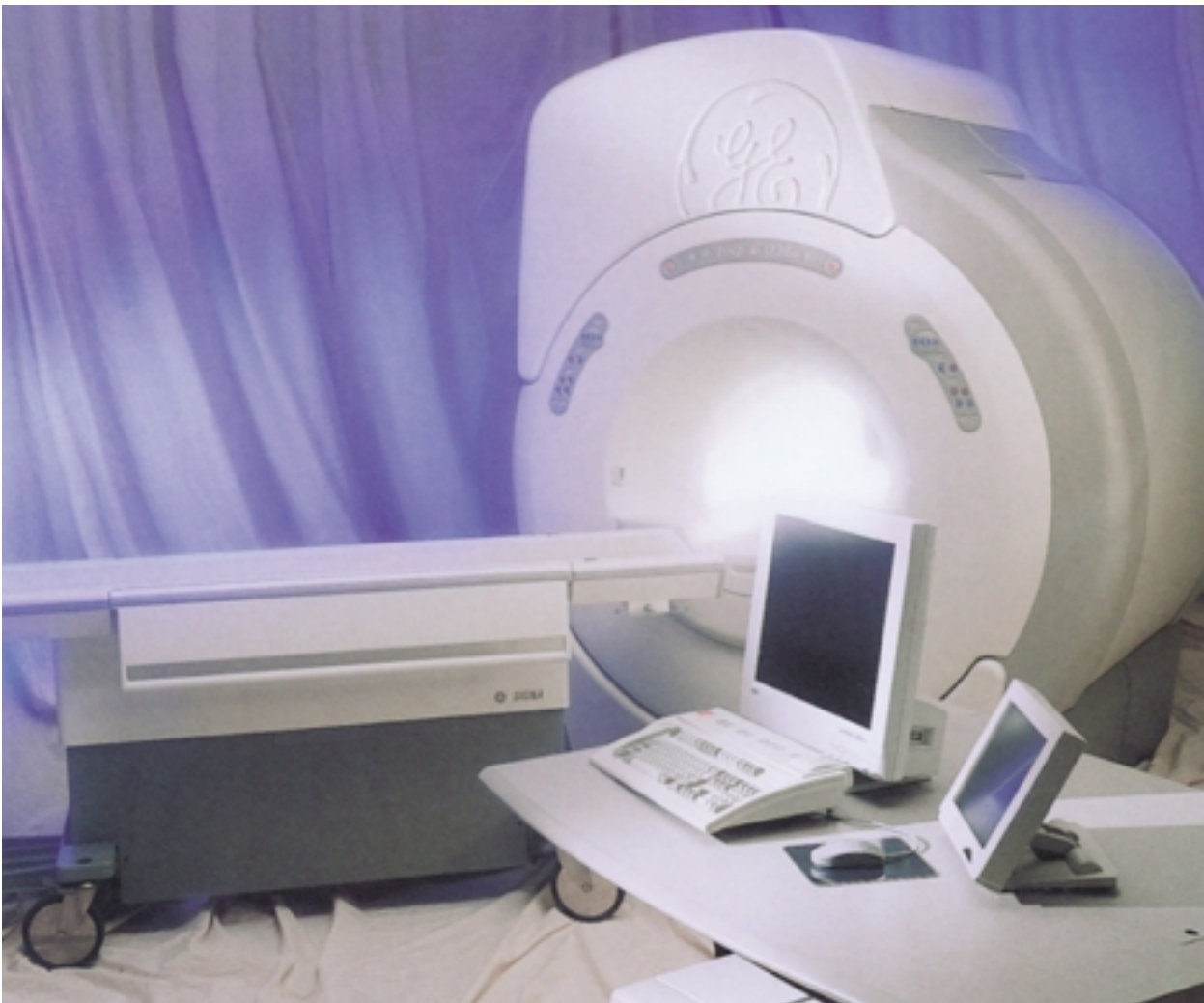

Figure 13.1 Example of a high field superconducting MRI system. Image supplied by IGE Medical Systems.

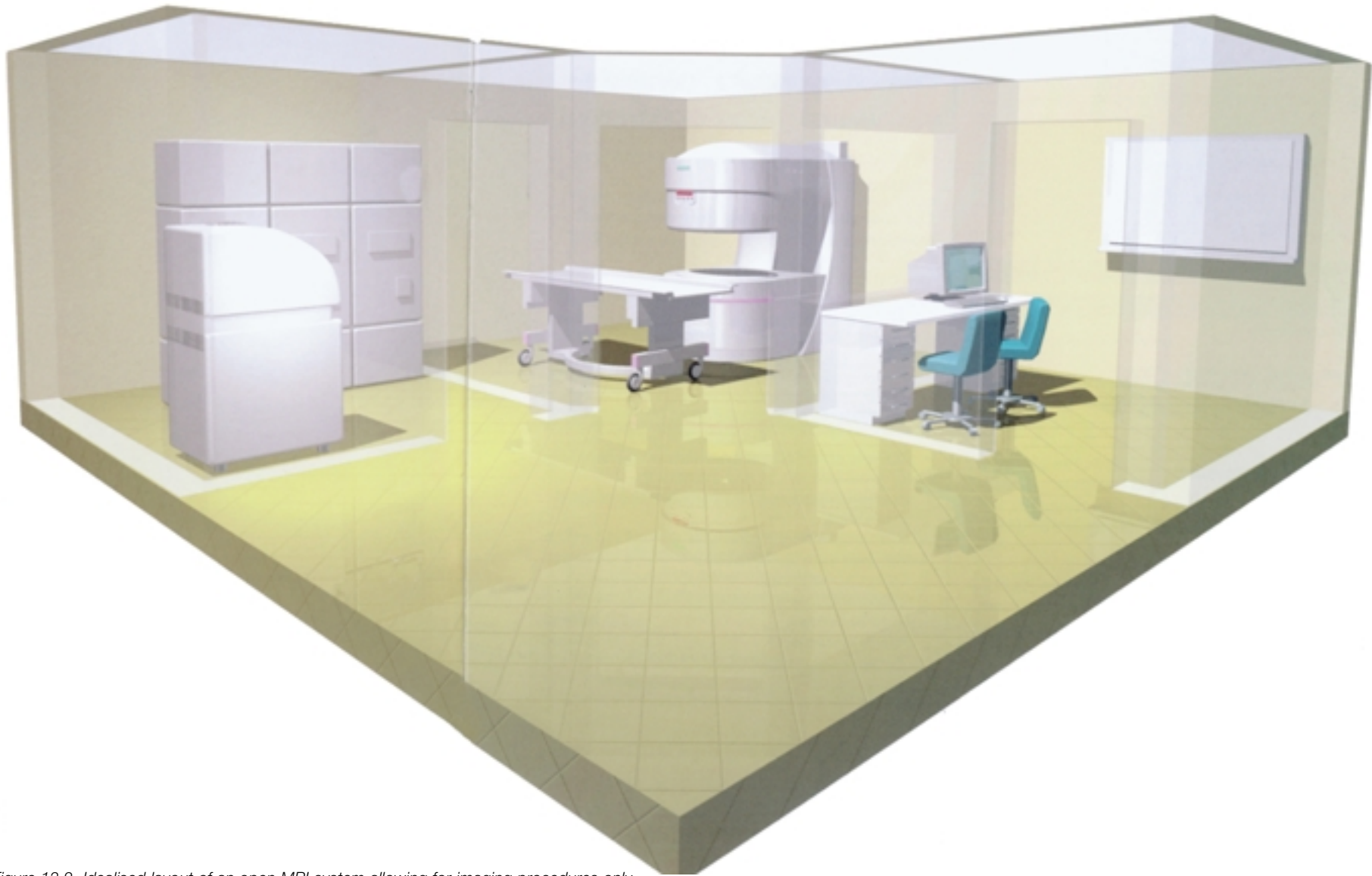

Figure 13.2 Idealised layout of an open MRI system allowing for imaging procedures only.
Image supplied by Siemens Medical Solutions Ltd.

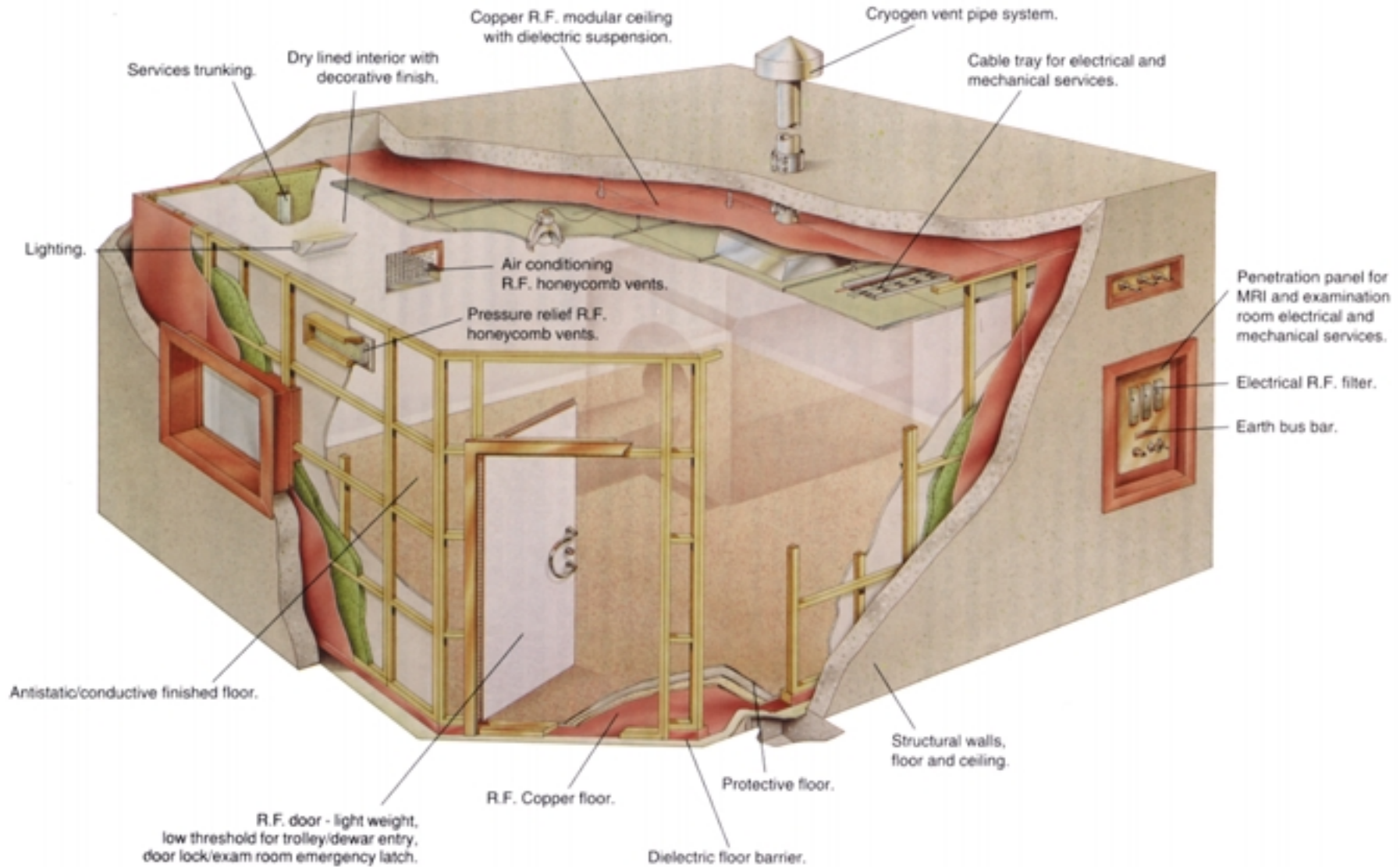

Figure 13.3 Image of a typical MRI scanner room.
Image supplied by Wardray Premise Ltd.

13.15 In many instances, MRI may be used as a secondary imaging technique. For example, in breast care it will follow on from the use of mammography or ultrasound. In some instances, the use of MRI to detect and quantify masses reduces the pressure for exploratory surgery and may offer much better definitions as to the limit or boundaries of the mass concerned, though there is considerable academic debate in this area.

13.16 In some cases, the appearance of a tumour in an MRI scan can offer important differential diagnosis evidence. For example, the invasion of surrounding tissues or organs by a nucleated mass may be detectable and thus the likelihood of malignancy can be ascertained. Equally, fibrotic coats and other characteristics of benign tumours are sometimes well imaged by MRI, though the applicability varies greatly with tumour type and anatomical distribution. In some instances, a differential diagnosis may be enhanced by the use of differing scanning techniques, or by the introduction of Gadolinium-DTPA, which is the most commonly used contrast media. The enhancement or otherwise of masses when DTPA is injected intravenously may be clinically significant.

MRI angiography

13.17 Many modern MRI systems are capable of generating angiographic images by so-called Time of Flight (TOF), or phase contrast, both of which use characteristics of the signal from moving fluids, or by the use of an injected contrast media.

Tumour staging

13.18 The principles of tumour staging are briefly described in the NHS Estates guidance on 'Facilities for cancer care services' and depend upon the application of a series of rules to the business of characterising a patient's condition. MRI is, for some tumour types, at least, the method of choice in determining the stage categorisation. However, it is unlikely that MRI will be used alone and its use in conjunction with radionuclide imaging, bone scanning and a range of other techniques is much more common.

Treatment planning

13.19 Although MRI does not have the ability to give a direct reading of electron density and, therefore, data related to linear accelerator X-ray beam dose distribution, it is, nevertheless, useful in treatment planning. Firstly, MRI information may be applied in locating the treatment target to reasonably high levels of precision and accuracy, though there are difficulties in that MRI lacks intrinsic spatial calibration, unlike CT. Secondly, the modality is of great value in determining the location, potentially within the treatment field, of vulnerable structures such as the spine, which would be



*Figure 13.4 Engineering for the integration of a radiofrequency shielded door.
Image supplied by lomedco Ltd.*

damaged by excessive irradiation, giving rise to difficult or unacceptable morbidity, with consequent loss of quality of life. Additionally, the ability of MRI to define the margins of some tumours is helpful in ensuring that tumour definitions or outlines are well-informed.

13.20 MRI data itself can be used directly in the planning process, within the constraints mentioned above, but equally the digital merging of CT with MRI data can overcome some of the limitations described. In particular, this process can be used to generate better spatial relationships in calibration as well as providing the electron or tissue density information, which MRI itself lacks. Accordingly, the use of merged CT/MRI data is increasingly common in the treatment planning process and the majority of RTP computers are able to either generate the merge process themselves or to receive merged data from other machines. In this context, the increased use of conformal therapy and IMRT may further stimulate the already substantial demand for MRI scanning in relation to radiotherapy treatment planning.

13.21 As the techniques used to administer chemotherapy drugs move toward a philosophy in which the drug is administered more directly to the tumour, MRI's usefulness in assisting in the accurate placement of catheters and other devices used for direct drug delivery may be expected to rise. This correlates with a much broader rise in the use of MRI for intervention generally. Much of this intervention will be geared towards cancer treatment.

Cancer surgery

13.22 The viability of surgery will frequently be affected by the combination of mass size and tumour staging information. Over and above this, the method of approach, or in sophisticated work, the trajectory, for a surgical episode may benefit greatly from the availability of MRI images, demonstrating not only the tumour itself but also the overlying tissues and location of vascular structures. Increasingly, MRI will be regarded as indispensable to the planning of modern cancer surgery.

Clinical follow-up

13.23 Follow-up scanning is closely related to tumour staging. Essentially, the principle is to monitor the effectiveness or otherwise of any treatments that are given. The regression of a tumour or loss of size may be an important indicator as to the success of any chosen treatment option. Follow-up scanning may mean that the patient is moved from a less successful to a more applicable treatment regime should this be indicated.

Further clinical uses

13.24 The following clinical uses have been identified:

- orthopaedic scanning services. A comprehensive orthopaedic scanning service may be offered by the hospital, including GP referred lumbar spine examinations and MRI arthroscopy;
- a general musculo-skeletal scanning service could be provided by the MRI scanner. This may be useful for sports medicine and lego-medical applications;
- neurological diagnostic scanning. For the majority of cases this comprehensive neurological scanning service is to be offered by the hospital, with some work being referred directly from A&E;
- diagnostic imaging and interventional radiology departments will usually offer a broad-based paediatric scanning service, replacing other examinations using ionising radiation, particularly CT, where applicable;
- abdominal medicine/gynaecology/pelvic imaging. This will mainly be in support to the examinations undertaken in CT, but it should be noted that MRCPs are gradually replacing conventional ERCPS using X-ray fluoroscopy;
- some centres may be interested in developing cardiac imaging to supplement existing X-ray cardiac angiography services;
- MR angiography. This area has been of particular interest since the relatively wide spread use of contrast media for these investigations. The majority of trusts would like to provide a reliable service for imaging the carotid artery, though other applications

may be developed;

- breast examinations. MRI mammography scanning services are used to supplement the X-ray mammography work already established clinically. The outcome of the current Medical Research Council (MRC) MRI mammography trial and the work carried out by Dr David Scott of the Christie Hospital, Manchester will influence greatly the use of this clinical practice.

THE PATIENT JOURNEY AND THE CONCEPT OF MAGNETIC CONTROLLED AREA AND SAFETY PRINCIPLES

13.25 Safety in the vicinity of and within the MRI examination room should be governed by local rules, which should be based on the MDA guidelines for Magnetic Resonance Imaging and those recently published by the NRPB. Some of the text within this chapter on MRI makes use of this guidance and the reader is referred to these documents for further reading.

13.26 In the majority case the patient will be visiting as an out-patient possibly as part of a co-ordinated exercise involving attendance at a clinic. A proportion of patients will be in-patients brought to the MRI suite from a ward and these will need to be accommodated within the suite design.

Reception

13.27 For out-patients, initial attendance will be to a reception desk, where a number of key questions will be asked and the process of assessing the suitability of the patient for MRI scanning begun. In particular, there is an immediate need to assess whether or not the patient has a pacemaker or is connected to any physiological monitoring device. Where this is the case, there will be a need for considerable care before the patient can proceed for scanning or, more commonly, the option for scanning will simply be rejected, at least for the time being. The receptionist will also be responsible for ensuring a careful check on the patient's identity, though the details of ascertaining the study to be performed will be dealt with through a referral form or as computerised information read by the radiographer. In some very modern facilities the study data can be downloaded automatically to the MRI scanner itself.

Patient's interview and checklist

13.28 A member of the professional team, most commonly a radiographer or nurse, will undertake a checklist with the patient and, if necessary, involve the referring clinician. This checklist will cover the following key areas:

- a. confirmation of the absence of a cardiac pacemaker, as the static magnetic field generated by the MRI scanner can interfere with its proper function;

- b. presence of other implants or prosthesis, as it is particularly important that this covers orthopaedic devices and dental plates. Where there is an ambiguity, aneurysm clips, being the most common example, the patient may be sent for an X-ray or, alternatively, the patient's notes may be consulted before the decision is taken to go ahead and scan;
- c. the presence of intra-ocular foreign bodies such as shrapnel and other metallic objects in the eye socket should be ascertained before scanning;
- d. patients who have a confirmed pregnancy and are in the first trimester may be excluded from scanning, depending on local policies;
- e. patients who are liable to fitting or who suffer from claustrophobia may require counselling or direct clinical supervision before they can be accepted for scanning;
- f. sundry precautions against hazards, which might be caused by the attraction of metallic objects to the MRI must be undertaken. Accordingly, the patient will be asked whether they are wearing any items containing metallic components, including jewellery and wristwatches;
- g. although unrelated to safety, practical common-sense dictates that the patient should be asked to remove all credit cards and similar materials that may be erased by exposure to the magnets.

13.29 Whilst the above-mentioned interview may normally take place in the waiting/reception area of the MRI suite, some patients may be unable to discuss sensitive or difficult matters in such an environment. Accordingly, occasional access to a more private room may be necessary. This could be a shared counselling and interview room.

13.30 For in-patients, the MRI checklist will often be dealt with before the patient is taken from the ward. This simplifies procedures in the MRI suite and also reduces the time that the patient needs to spend outside the care of ward staff.

Patient changing

13.31 Depending on the anatomy to be examined, the patient will normally be asked to change into an examination smock and all valuables and common metallic objects will be deposited into a locker, so that they are not taken into the examination room itself. Plastic or aluminium keys are used for these lockers so that the patient may retain possession.

13.32 Hearing aids should be removed to prevent damage arising should they enter the MRI examination room or the MRI scanner bore itself. However, patients

with hearing loss will need to hear and understand instructions from staff before, during and immediately after the examination. Accordingly, MRI units are equipped with pneumatic speech systems and in some instances ear tubes can also be attached. For the profoundly deaf, no satisfactory mechanism for communication is currently available. At least some of these patients, together with those who have aneurysm clips or some other disqualifying implant, are likely to be referred for CT scanning as an alternative to MRI.

13.33 The patient will be taken into the scanning room, escorted by a member of staff. Unescorted patient access is not permitted. In the general case, the patient will be positioned onto the couch, which is height adjustable, aligned using reference light beams supplemented by external lasers as needed and then mechanically conveyed into the aperture of the MRI scanner to the scan plane.

13.34 The scanning process itself is semi-automated and will be controlled by the radiographer located at a control station, which should afford a reasonable view of the patient. It is important that the RF door is closed before scanning commences. Music systems may be installed in order to assist in rendering the potentially prolonged periods of scanning more acceptable. Entertainment systems are normally restricted to sound only but MRI compatible television is available.

13.35 Some patients may receive a single scan only, but more commonly these will be grouped together into compound protocols targeted on the clinical purpose. It is common for patients to undergo a number of scans at different parameters, giving differing images of the same anatomy and also for angiographic examinations to be performed as part of the same exercise. In the majority of cases, only a single imaging coil will be employed, but most modern MRI scanners can utilise several such coils together. Where such a capability is not present, it may be necessary for the radiographer to re-enter the room at the end of each scanning sequence to change the coil in use and/or reposition the patient.

13.36 Following scanning, it is not usually necessary for the patient to remain within the bore since the data can be reviewed very quickly. The decision on any supplementary scanning may, however, under some circumstances require a consultation. Here, it may be necessary to transmit the results of the examination to a computer workstation elsewhere. Where this is the case, the patient may be asked to wait until feedback is received from that member of staff. In such instances, the radiographer or other assisting staff members will ensure a good flow of information to the patient and that the patient remains comfortable and as calm as possible.

13.37 The patient is removed from the scanner by a simple reversal of the loading process using the mechanically driven couch. For ambulatory patients they will not normally be detained in the MRI suite following scanning. For inpatients, it will be necessary for the normal process of escort and portering to be undertaken.

Patient preparation area/anaesthesia and recovery area

13.38 A small proportion of adult patients and virtually all children may require heavy sedation or anaesthesia and have a somewhat different scanning process. In cancer centres, as distinct from more general MRI facilities, anaesthetics will normally be administered outside the MRI scanning room and maintained during scanning by the use of piped gases and appropriate monitoring. This implies that in some suites, particularly those concerned with children, a room for the administration of anaesthetics will be necessary. Equally, after scanning, patients will require recovery time, though it is unlikely that the workload, even in a highly specialised centre, would justify a recovery room separate from that in which administration of anaesthetics takes place.

Trolley and wheelchair storage area

13.39 Disabled patients have special problems in gaining access to MRI services. Wheelchairs are unlikely to be suitable for entry into the MRI room though entry to the surrounding suite will not represent a difficulty. In order to maintain satisfactory DDA access, it will be necessary for MRI departments to have access to MRI-safe wheelchairs and trolleys. As an alternative some designs of MRI scanner permit the scanning couch to be detached from the rest of the assembly so that it may be taken out into the reception/waiting/patient preparation area and the transfer of the patient accomplished there. For patients who have particular difficulties with movement or who are suffering pain, this solution may often be the most satisfactory. Facilities for the storage of trolleys and wheelchairs must be considered.

LIST OF ACCOMMODATION AND FACILITIES FOR WHOLE BODY IMAGING SUITES

13.40 In addition to examination room(s) the following rooms should be provided:

- a patient preparation area used for inducing anaesthesia and recovering the patient following the examination. In some exceptional centres where high numbers of children are examined or large numbers of interventional procedures undertaken, separate facilities may need to be provided. This could be

shared with facilities provided for CT or X-ray interventional vascular or non-vascular work;

- engineering or technical room for the installation of the gradient coil cabinets, compressor and RF generator;
- main and sub-waiting areas for patients. The main waiting area may be shared with CT or another modality, except those for radionuclide imaging and PET, because of the radiation risks;
- a control room for housing the main workstation computer, the radiographic staff and other healthcare professionals during scanning. This may be shared with CT, for example;
- a small area to allow the storage of a non-magnetic trolley and wheelchair for use in the MRI scanner room;
- dedicated changing facilities for staff patients, which comply with the DDA;
- office(s) and or reporting facilities for the clinical interpretation of the diagnostic images obtained. This may be a combined facility with other modalities;
- accommodation for visiting professionals. This may take the form of "hot desk" space within the control area;
- a reception and storage area for patient records. This may be shared with the main reception area for CT;
- clean and dirty utilities particularly if interventional work is to be undertaken in the examination room. This may be shared with other modalities;
- business manager's or administration office, where MRI and possibly CT are separate from the main department;
- chilled water supply generator. This may supply chilled water to more than one modality and does not have to be adjacent to the MRI examination room or suite;
- counselling or interview room.

ROOM AND EQUIPMENT DESCRIPTIONS

Patient, staff and visitor lockers

13.41 A bank of small "cube" lockers is required, where patients, staff, escorts and visitors (under the supervision of an authorised person) who are entering the MRI scanner or examination room can securely store items of personal belongings that may not be taken into the scanner room. The lockers should be provided with non-ferromagnetic (for example brass or plastic) keys, which can be taken into the MRI scanner room safely.

Patient toilets

13.42 WC facilities for patients should be provided close to the sub-waiting area. At least one WC should be wheelchair accessible. Where space available is small, there may be some advantage in sharing this facility with the main waiting area or another modality suite such as CT.

Cleaners' store cupboard (dedicated for non-ferromagnetic materials)

13.43 A lockable cupboard for the storage of cleaning equipment should be provided within or adjacent to the MRI suite. Only dedicated non-ferromagnetic cleaning equipment should be kept in this cupboard.

13.44 It should not be used for any equipment that may prove hazardous if inadvertently taken into the MRI scanner room.

Resuscitation bay

13.45 Due to the nature of the resuscitation equipment used in hospitals, it cannot be used in the magnetic field environment. Patients that have a cardiac or respiratory arrest, for example, removed from the MRI examination room and taken to a separate resuscitation area. Ideally, a separate area of similar design and construction to a single bed anaesthetic/recovery room should be provided. However, in the majority of cases, due to space limitations this will need to be shared with the facilities described below.

Anaesthetic/recovery area

13.46 In designing the anaesthetic/recovery bays, consultation should be made with the surgical anaesthetic team on equipment requirements and planning relationships with the rest of the department. Reference should also be made to the guidance produced by the joint working party of the Royal Colleges of Radiologists and Anaesthetists.

13.47 A two-position anaesthesia/recovery bay is normally adequate on the assumption that a small number of patients may require anaesthesia or sedation. If it is intended to group all patients requiring anaesthetic together in one session, then project teams should give consideration to patient flow issues and the adequacy of a two-position bay. In specialist paediatric or larger institutions, or where large numbers of interventional MRI procedures are considered, it may be appropriate to have a much larger provision of bays, separate resuscitation/anaesthetic rooms.

13.48 The patient is anaesthetised on the bed or trolley on which s/he arrives, and is transferred to the "non-ferromagnetic MRI trolley" to be moved to and from the MRI scanner room.

13.49 The bed or trolley can be parked in the anaesthesia/recovery area bay until the patient returns. The patient will be returned to the bed or trolley for recovery and subsequent exit from the MRI suite.

Design considerations

13.50 Privacy and an environment with minimal disturbance are important. The bay should have walls on three sides and cubicle curtains to the opening and between each position.

13.51 There should be adequate space around the patient on a bed or a trolley in each position for staff to move and work, and for equipment to be moved and parked while in use. In larger facilities of three or more beds, the provision of a small nurse's workbase will be appropriate. In addition, the following equipment should be provided:

- a. clinical hand-wash basin and accessories;
- b. a general sink unit combined with a worktop for laying out instruments;
- c. good provision for the storage units for drugs, sterile supplies and infusion fluids and, in some cases, contrast media;
- d. a controlled drugs cupboard and refrigerator;
- e. a warming cabinet for heating contrast media to body temperature before administration.

Engineering features

13.52 Medical gases including wall-mounted piped oxygen, nitrous oxide, medical compressed air and medical vacuum outlets, anaesthetic gas scavenging should be fitted at the "head" of each bay. Alternatively, oxygen and vacuum services could be provided in association with mobile anaesthetic services.

13.53 Electrical power sockets, intercom and telephone point, staff emergency call point in case of, for example, cardiac arrest should all be provided.

13.54 It is preferable if each position is laid out in a manner similar to the anaesthetic rooms in the main operating department, in order that common working practices can be followed.

Planning relationship

13.55 The anaesthesia/recovery bay should be close to the MRI scanner room, so that the anaesthetist and assisting nurses can quickly and conveniently move between the two spaces.

Interviewing/counselling room

13.56 An interviewing/quiet room should be provided within or close to the MRI suite.

13.57 The interviewing room should be used for pre-examination discussions before a patient enters the examination room and may be used for some post-examination procedures or discussions.

13.58 The room should be comfortably furnished and include easy and upright chairs and an occasional table. A desk and chair should be provided to enable a member of staff to make notes while talking to a patient and/or escort.

13.59 The walls of the interviewing room should be constructed to attenuate sound and provide an adequate level of privacy. The room should be close to the patient preparation rooms and sub-waiting area, if provided, and easily accessible from the MRI examination room.

MRI examination room

13.60 The design of the MRI examination room should be clinical in character, but moderated to reduce anxiety to patients and, in some cases, carers and nurses. The MRI examination room will make up part of the inner controlled area (MDA Guidelines for magnetic resonance diagnostic equipment in clinical use) and there will be a need for permanent signage to indicate the presence of a strong magnetic field and warn people of the potential effects on pacemakers and ferromagnetic objects. The floor may also be marked to indicate the presence of the inner controlled area.

13.61 The maximum occupancy pressure in the room will be between two and eight people in addition to the patient, particularly if interventional work is a potential clinical function in the examination room, either with the proposed unit or as a future operational requirement. The current clinical requirements, patient care and throughput will influence the type of magnet procured. The room should be made large enough to allow people to move easily between the end of the scanner couch and one of the adjacent walls in the examination room. In situations where a cryogenic magnet is installed, the room should allow for access of large helium Dewars to be brought close to one side of the magnet, to allow for a cryogen refill, which will take place once every one to two years depending on magnet type and manufacturer. On-site storage for cryogenics will not be required. The room should allow patients to be transferred to the patient couch via the use of a non-magnetic patient transfer trolley, even if the magnet is equipped with a detachable patient couch. This will protect operations on the possible occasions where the patient couch fails,

more likely to happen as it gets older, and will future proof the design for future MRI systems.

13.62 All surfaces should be easy to clean, including floors and the ceiling, and have minimal fissures to minimise the spread and ingress of infection and dirt throughout the examination room. The suspended ceiling should be manufactured from non-magnetic components to insure that it is not affected by the magnetic field. The furniture should be magnetically compatible and this usually takes the form of plastic chairs, which are necessary when an escorting clinician remains with a patient in the examination room during a procedure. A hand-wash basin and/or a scrub sink should be provided, possibly within the examination room and should be designed using MRI compatible fittings and fixtures. In essence, all fittings in the MRI examination room should be magnetically compatible, including those used in the construction of shelves, cupboards and other room fittings.

13.63 A large cupboard should be provided for storage of receiver coils in the MRI examination room. The design of the cupboard should respect the lifting and handling policies that may be in force at the hospital, as some of the coils are heavy and difficult to manoeuvre. The spacing between the shelves of the cupboard should allow for the storage of all the receiver coils provided with the scanner. In addition, it should allow for storage of copper sulphate solution QA imaging phantoms, which, again, are bulky. Additional storage space should be provided for clinical items and contrast media, which are now used in a wide range of examinations. The contrast media will be used in conjunction with a magnetically compatible power injector, which may be either floor- or ceiling-mounted. The function of this device will be integrated into the function of the MRI scanner to ensure accurate timing and delivery of the bolus. A nurse or radiographer may have to wait in the room during an examination to ensure that the contrast media has not issued during the procedure.

13.64 The room should be equipped with an oxygen monitor to ensure that any helium gas leaking from the cryogenic Dewar is not moving into the examination room, thus displacing the oxygen and compromising patient safety. In addition, the room should be fitted with an emergency quench switch which should be protected against accidental use. This will effectively reduce the field of the magnet but multiple quenches maybe required to bring the field down to safe levels. Additionally, the magnet may be fitted with emergency "off" switches, which will suspend scanning and switch off power to the magnet sub-system, but will not quench the magnet.

13.65 The walls of the examination room will be made up of a continuous copper RF shield, acoustic and, in some cases, magnetic shielding, coupled with more standard materials and construction methods. A cut away section of an MRI examination room is shown in Figure 13.3. The design of one of the walls may have to allow the regress of the old unit and ingress of a new MRI system and should be constructed to facilitate this activity or procedure. The door will need to be RF shielded and an RF window built in to the construction of the wall separating the control and MRI examination rooms, to allow the radiographer to see the patient when scanning. The door will need to be locked when the room is not being used to prevent unauthorised access and the fitting of key coded key operated locks is advised. The window should be constructed to allow the radiographer to see down the centre of the scanner whilst maintaining an overview of the whole examination room. RF windows can be built in the design of walls that are directly adjacent to the outside of the building but it should be noted that this is an expensive option. If these windows are fitted, blinds should be hung to allow variable lighting conditions in the examination room.

13.66 In order to maintain the integrity of the RF shielding, all services to the MRI examination room from adjacent spaces (control and technical) should be brought into the examination room using wave-guides. In this instance, these devices are effectively small copper pipes that are used to enable the electrical supplies and other services to enter the room without compromising the integrity of the RF shield. The length of these devices will depend on their diameter and is governed by a simple equation. The equation can be found in manufacturers' literature.

13.67 The nurse call and clinical emergency buttons will usually be integrated with the function of the MRI system. All other patient monitoring facilities should be MRI compatible and connected to the patient using optical isolation devices. Power to these devices should be established using leads connected to sockets through wave-guides between the control and examination rooms.

13.68 Alignment and positioning reference beams for radiotherapy planning purposes are usually generated by a low power laser system. The use of optic fibre light transmission from a generator located outside the scanning room should be considered in this regard to avoid possible problems of the magnetic field interfering with the generation system.

13.69 Optionally, piped anaesthetic facilities may be provided for patients that will be anaesthetised during the examination. Alternatively, this could be provided by the use of mobile trolley based anaesthetic facilities. Piped anaesthetic facilities may be a requirement for

paediatric patients or where hospitals are anticipating undertaking interventional procedures either now or in the future. If patients are to be sedated during an examination, then remote monitoring can be achieved, using a colour CCTV monitor located just behind the MRI scanner and linked to a colour monitor in the control room.

13.70 A minor-procedures or small operating lamp may be required to facilitate some procedures in the MRI examination room. There are currently no MRI compatible minor procedures lamps available in the UK and such devices have to be made to order.

13.71 Where interventional use is contemplated, particular care must be taken to control infection. This will influence airflow and filtration, surface finishes and ceiling construction. The advice contained within HBN 26, 'Operating department', HTM 2025, 'Ventilation in healthcare premises' and new NHS Estates guidance 'Infection control in the built environment', may be of value.

Engineering or technical room

13.72 The engineering or technical room will house all the subsidiary equipment associated with the MRI scanner such as the gradient cabinets and radio-frequency generators, which are used to power the receiver and gradient coils within the MRI scanner. The room may also accommodate a closed loop chiller unit, which would supply cold water to the cold head of a cryogenic MRI system to maintain the levels of liquid cryogen in the MRI scanner. The room may need to accommodate a large metal box for the storage of reference and maintenance manuals. The majority of the manuals are now being provided on CD-ROM.

13.73 The technical room should be located directly adjacent to the MRI examination room so that services between the MRI scanner and technical rooms can be easily installed with the minimum amount of cabling. In order to accommodate the distribution of services between the technical and examination rooms, it is customary to install a radio-frequency pad, which basically consists of high density of wave-guides in a single location. The pad is covered in a wooden box for cosmetic purposes. A raised access floor may be provided in order to facilitate this arrangement, close the to the rear of the MRI scanner when viewed from the control area.

13.74 The occupancy pressure in this space will be a minimum of two up to a maximum of three persons. However, space to meet the manufacturer's requirements should be provided around the electronics cabinets, to allow access for engineers during planned maintenance visits. This will have an effect on the layout of the rooms. It is advised that only authorised persons

enter into the technical room. These will include engineers, radiographers and physicists and access should be controlled by providing security locks on the entrance door. The door should be fitted with signs to indicate the presence of an electrical hazard. The room should be designed to be easily cleaned. Patients will not enter this area; members of staff and engineers will only spend relatively short amounts of time here. Painted block-work finishes are acceptable and no special considerations apply. Bright lighting conditions will be required to support maintenance of the gradient cabinets. The room must be maintained as clean and dry at all times to minimise any problems with the gradient cabinets.

13.75 Storage space for bulky non-magnetic tools and QA phantoms may be required, depending on space allocated in the MRI examination room for these items.

13.76 The gradient and radio-frequency generation cabinets will produce significant heat yields, particularly when scanning is initiated, so the mechanical or air conditioning should be designed to handle the heat loads and maintain the environmental conditions within manufacturer's tolerances.

13.77 The floor should be adapted for use with high capacity trunking. The fitting of load bearing "computer" flooring may be appropriate. The flooring may also be part of the raised flooring the MRI examination room. An emergency off switch should be placed in this room to shut down the electrical supply to the equipment in an emergency.

Control room

13.78 The control room will be used to control all MRI scanning processes and support the clinical/technical discussions in support of the diagnostic imaging and treatment process. The design of the room should take on a high quality office character, with some emphasis on maintaining a clean and dust free environment. The room will need to be designed to incorporate a number of electrical and data connections between the technical room and MRI examination room and this should be considered in overall design terms. All single-phase 13A sockets should be placed above benches and shelves in order to improve access.

13.79 The room must accommodate MRI control desk and workstation, monitoring equipment, sundry file storage, safety equipment, computer media, sundry office functions, and hard- and soft-copy viewing. Computer terminals for selected systems, which will vary locally and may include a RIS, PAS or HIS. X-ray film viewing boxes should be included in the room design even if the hospital has made the transition to a film-less working environment, as there may still be a requirement to look at films from other hospitals or old

images that have not been digitised. Bench space close to the MRI control console should be provided for temporary and permanent patient monitoring equipment and instrumentation, so that the radiographer or visiting clinician can easily observe.

13.80 The occupancy of the room is estimated to be between two and eight persons. It is estimated that, usually, three persons, radiographers and a radiologist, will be in the control room whilst scanning is being undertaken. Other persons who may be present include radiographers, visiting engineers and physicists, and clinicians, including surgeons and anaesthetists. In a teaching environment, student radiographers and trainee radiologists may also be present during patient examinations. Chairs and personal workspace for three persons seated should be provided

13.81 The control room should be located directly adjacent to the MRI examination room. The radiographer should be able to see along the bore of the magnet and the whole of the examination room when scanning a patient. The use of an RF window to achieve this purpose is discussed above (paragraphs 13.60 to 13.71). There may be some planning and clinical advantages in designing a combined MRI/CT control room as the modalities have some similarities. The design of the room should allow the radiographer to have a direct view of the MRI examination room entrance to ensure control of access and prevent unauthorised persons entering the examination room.

13.82 Where space available is limited, a cross-sectional imaging workstation could be installed in this area. However, as this unit may be used for reporting on images, it would be preferable to install it in a directly adjacent office, equipped to reporting room standards. A compact dry laser imager may also be incorporated into the design of the room, if space is limited in other parts of the suite. An outside window should be provided if this feasible in the design, and should be fitted with a black-out blind to provide some light control. Variable illumination will be required in the control room to assist with the review of clinical images on workstation monitor, therefore provision of dimmer switches to control the light in both the examination and control rooms is required.

13.83 There will always be a significant machine heat yield in this area. The number of persons in the room may further exacerbate this. Mechanical ventilation or air-conditioning will always be required.

13.84 Care must be taken over controlled area status. Under the MDA's 'Guidance for magnetic resonance equipment in clinical use', 1993, specific access control is required. There are additional considerations if the control room is within an outer-controlled area with more than 3 to 5 gauss present. Safety considerations and

special requirements for monitors and display devices to operate without distortion in low magnetic field environments should be considered.

13.85 An emergency MRI electrical isolator push-button should be included in the design of the room. In some cases, this is incorporated into the design of a MRI console, but project teams should actively consider the provision of an additional switch. A second protected quench button can be fitted in this room, if this is considered necessary to satisfy local procedures and policies.

13.86 The Magnetic Resonance Control console (MRC) may be connected to a network for transmission of data and images to other parts of the hospital. In addition, the manufacturer will wish to connect the MRC to a telephone line through an in-built modem, to permit some quality control procedures to be undertaken remotely. However, this may conflict with NHS connection rules and a proposed solution to this challenge is described in Engineering requirements, [Appendix 2](#).

13.87 Small staff lockers with non-ferromagnetic keys for valuables and metallic personal items including magnetic devices such as credit cards should be located in this area for radiographers and other clinicians who may be working in the examination room.

SITING REQUIREMENTS AND CONTROL OF RADIOFREQUENCY (RF) RADIATIONS

13.88 Most commonly, existing MRI suites will be integrated into diagnostic imaging departments. In some instances the MRI suite may form a completely separate entity. With the continuing rapid increase in the demand for MRI scanning services, particularly within oncology and possibly orthopaedics departments, it is likely, however, that business cases will increasingly be able to justify MRI that is dedicated to services or shared with a restricted range of other healthcare demands.

13.89 The very strong magnetic field used to align the proton spin axis as described in the introduction to this section generates a fringe or waste field, which appears in the environment around the scanner. In general, on MDA advice, this field must be constrained to 0.5 mT (5 gauss) for safety purposes, but some instrumentation, including TV monitors and image intensifiers, will not operate correctly when subjected to magnetic fields as low as 0.01 mT or 0.1 gauss. This may influence the siting of MRI units. A list of some of the equipment affected by the stray magnetic fields is shown in Table 13.2. This list is not exhaustive and the susceptibility of equipment to magnetic fields should be checked when installed into spaces adjacent to the MRI examination room.

TABLE 13.2 EXAMPLES OF DEVICES AFFECTED BY STATIC MAGNETIC FRINGE FIELDS

Field intensity Gauss	Devices affected
30	Video terminals videotape magnetic disks
10	Computer optical disk drives X-ray tubes HVAC equipment Telephone switching Credit cards Watches and clocks
5	Power conditioner Winchester disks Tape storage devices Cardiac pacemakers Credit cards
2.5	CT scanners TV monitors Power transformers Ultrasound equipment Main electrical distribution transformers
0.5–1	Radionuclide imaging cameras Positron Emission Tomography devices Spectroscopy colour monitors Cyclotrons Electron microscopy devices Linear accelerators Colour televisions Radiotherapy simulators Solid state image intensifiers Direct X-ray equipment
<0.5	Computed radiography equipment Conventional caesium iodide image intensifiers

13.90 The fringe fields generated by open magnet systems, either cryogenic or non-cryogenic may be larger than those generated by higher strength whole body magnets. The reason for this, primarily, is that the design of the open magnet systems means that they are unable to incorporate active shielding around the whole of the magnetic field.

13.91 If it is necessary to site equipment within fringe magnetic fields that may cause them to malfunction, or if it is not possible to contain the 0.5mT field to within the examination room, then some magnetic shielding may be required. This can be achieved by the use of iron or steel directly incorporated into the structure of the building. In general terms, this will usually relate to between 2 mm and 5 mm and in the worst cases up to 10 mm thicknesses of iron cladding. This will have large implications for the overall structural design of the building and should be considered early in the project. The thickness can be varied around the areas of the room and the largest amount of iron can be located in areas where there is most need. This will have the effect

of reducing the overall area of the fringe field around the magnet. Consultation with a specialist supplier or recognised expert is advised, as they will be able to assist with the mathematical modelling necessary to determine the amount of iron required around the examination room, including those areas above and below the MRI system. In particular, shielding may need to be provided where MRI units are installed close to gamma cameras, CT scanners, and CR and fluoroscopy equipment.

13.92 The user should consult with the manufacturers of any equipment that will be sited close to the MRI examination room and with the original equipment manufacturer of the MRI scanner. The extent of the fringe fields used to be proportional to the strength of the magnet, but improvements in the design of systems has meant that the fringe fields from 1.5 T magnetic field systems are now similar to their 1.0 T counterparts. Consideration should be given at initial project design stages to future proofing the suite for possible later installation of higher field strength magnets. The design should not be “shrink-wrapped” around a particular type or field strength of magnet.

13.93 A more cost-effective solution than the provision of steel shielding may be possible where there is an outside wall. It may be possible to provide fences and other measures to restrict access and prevent unauthorised persons entering an outside area where the field may exceed 0.5mT.

13.94 Delivery and installation access for MRI systems may also be a constraint upon their siting. Normally the MRI gantry itself cannot be dismantled for delivery, though it is common that the outer covers are removed. This will leave an object with exterior dimensions of 2.8 m x 3.0 m x 3.0 m. Clearly such a large object, which will weigh between 2 and 9 tons, will require special consideration in terms of corridor access, access for delivery vehicles and haulage in lifts, particularly if the MRI suite is located other than on the ground floor or in a basement. The use of external delivery cranes is common, but very expensive.

13.95 Magnetic Resonance Imagers are susceptible to the effects of mechanical vibration and the site selected should be well away from sources such as railways, underground lines, and major roads. On some sites this will be a significant constraint, necessitating consideration of special foundation designs and insulated structures which can be costly.

13.96 The homogeneity or uniformity of the magnetic field discussed above is seen as being pivotal to good imaging, and performance of the MRI system can be distorted by the proximity of large ferromagnetic or metallic structures. All systems incorporate some form of multi-level shimming, which can be used to correct the distortion caused by some ferromagnetic structures, but this can only work for some objects, depending on their size and proximity to the MRI examination room or the magnet. Table 13.1 shows the minimum distances which should exist between the MRI scanner and ferromagnetic objects to prevent distortions in the uniformity of the magnetic field caused either by vibrations which they cause or the magnetic field generated.

13.97 The list provided is not exhaustive and should be used for general guidance only. A full site survey to determine the presence of ferromagnetic masses and potential sources of vibration should be undertaken before the proposed installation site is chosen.

13.98 There are many and varied types of equipment that can affect the uniformity or correct operation of the MRI system and consideration of this issue needs to take place in the planning stages. All the equipment manufacturers will be able to provide literature on the types of equipment that can be installed within the proximity of the magnet.

13.99 The siting of MRI suites next to CT scanning facilities to create a cross sectional imaging capability is often seen as posing significant clinical advantages. However, particularly where high field MRIs are employed, great care must be taken to ensure that the concomitant magnetic field will not give rise to difficulties for the CT equipment.

14 Mobile vehicle scanning units to include CT/MRI and PET

BACKGROUND AND INTRODUCTION

14.1 A mobile diagnostic imaging unit (mobile) consists of self-contained scanning and control equipment housed in the trailer of an articulated vehicle. Usually, the imaging equipment is installed directly into a trailer and cannot be removed. In some instances, the vehicle may be used only to transport the imaging modality. Upon arrival at the hospital the equipment is transferred to a suitable operational space.

14.2 A number of diagnostic imaging services can be provided using this method, for example lithotripsy, mammography CT, MRI and, in some cases, fluoroscopy/fluorography units. The following text concentrates on the built environment implications for mobile units visiting hospitals. It does not focus on mobile mammography vehicles providing a screening service to the community.

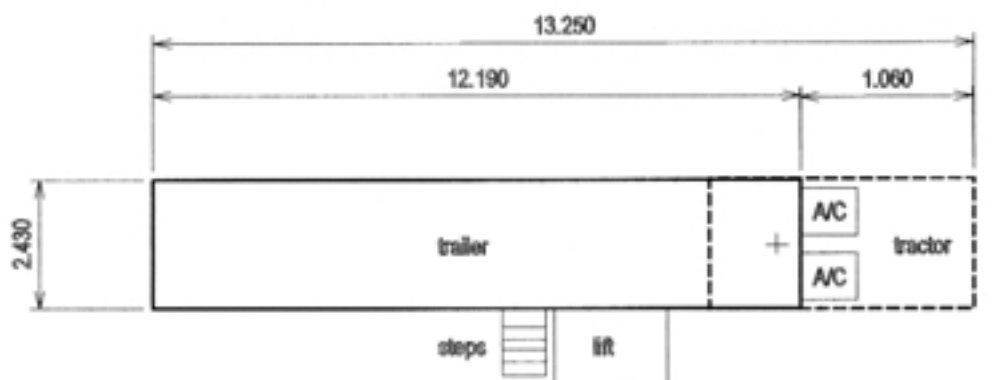

PLAN SHOWING OVERALL DIMENSIONS AND PATIENT ENTRANCE

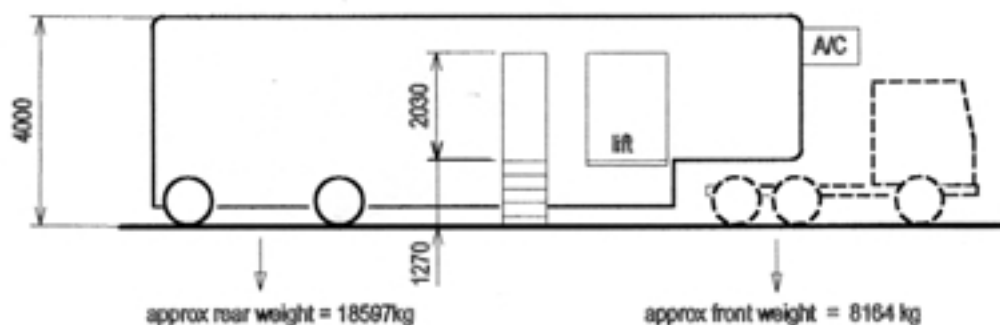

KERB SIDE ELEVATION.
Tractor unit will usually detach from trailer during operational sessions

FOR FURTHER DETAILED INFORMATION REFERENCE
SHOULD BE MADE TO CURRENT OPERATORS INFORMATION

Figure 14.1 Diagram showing the vehicles used to transport the modalities between hospitals.

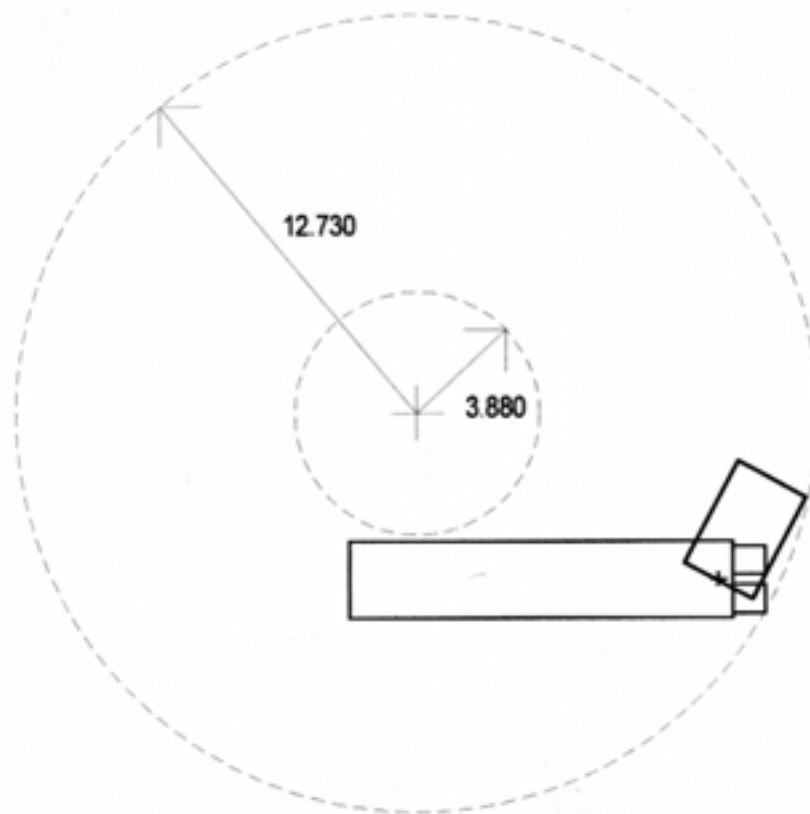

Figure 14.2 Diagram showing the turning circle of an articulated vehicle containing a diagnostic imaging unit.

14.3 The provision of a mobile unit may be appropriate in the following circumstances:

- a. during replacement of diagnostic imaging equipment. The changeover period may not be long enough to justify the creation of a scanner in a temporary installation, so to maintain the service the provision of a mobile service may be appropriate;
- b. if an existing modality is undergoing a major repair or upgrade that may last up to a week or more. The hospital may wish to maintain a service in order to avoid a build up of patient waiting and access times;
- c. in some instances it may not be justifiable, in business planning terms or expected patient numbers, to provide a full time fixed diagnostic imaging service, such as MRI or CT, and therefore the provision of a mobile serviced providing a service one to two days per week may be appropriate;
- d. a mobile may be used to reduce waiting times for examinations at times of high demand by supplementing a permanently installed modality. This may be particularly true for MRI scanning services.

14.4 In the construction of new hospital buildings, it is strongly advised that provision of a mobile unit is considered, even if the hospital decides to install a wide range of imaging modalities including CT, MRI and,

possibly, PET. It is likely that a unit may be required for one of the reasons discussed above, during the lifetime of a building set aside for diagnostic imaging.

14.5 The clinical targets for these units are the same as for fixed units, except that it may not be possible to undertake interventional procedures or procedures where the patient has to be anaesthetised. There may be an exception in this instance if raised, purpose designed enclosed walkways are constructed from the hospital to allow direct access to the mobile vehicle imaging unit.

14.6 The site, including its construction and preparation, is not part of the mobile imaging unit and the preparation costs for these items are the responsibility of the hospital, unless undertaken as part of a PFI, PPP arrangement or similar venture. In some instances, the supplier of the fixed imaging equipment may meet some of the costs when the mobile unit is used to maintain service during a major repair, upgrade or replacement. This will be dependent on local arrangements and the overall financial arrangement.

14.7 The planning process should include consideration of pedestrian, patient, technician, and vehicular traffic flow patterns as well as other considerations outlined below.

SEQUENCE OF EVENTS

14.8 The normal sequence of events leading to a patient scanning session is as follows.

- a. the mobile unit is driven to the site and parked at the designated location;
- b. any necessary safety items are set in place and necessary traffic barriers are set up;
- c. on-board systems, such as power and water are connected to the scanning equipment within the articulated vehicle and final calibration and QA procedures start. During the initial visit to a site, this may take several hours, but for subsequent visits to the same site, the overall process may be much reduced. The designated site for the articulated vehicle should be marked approximately on the floor, as large changes in the scanner's position may have an effect on the overall set-up parameters and measured fringe fields.

For MRI scanners this process can take longer as the system has to be filled with cryogen on arrival at the site. The magnetic field may also have to be ramped to its full working status and the magnet may have to be re-shimmed;

- d. upon successful completion of calibration and QA checks the unit is available for patient scanning.

14.9 The following paragraphs indicate in more detail the considerations needed in the planning the installation of a mobile scanning unit site.

SITE SPECIFICATIONS

14.10 In all circumstances a full site survey should be undertaken when introducing a mobile vehicle service into an existing hospital. Factors that should be considered are listed and described below. They should also be considered when planning or building a new hospital.

Size

14.11 The site must be large enough to accommodate the whole of the articulated vehicle and allow the towing section to be detached from the trailer. [Figure 14.1](#) shows the size of the towing vehicle and trailer.

Access to the site

14.12 The vehicles require clear access to the selected site, with no tight-radius curves, overhead obstacles or narrow alleyways. The roads must be wide enough to accommodate the vehicle. Its overall width dimensions are shown in [Figure 14.1](#). The vehicle should not pose a risk to other patients or staff when entering the site. The sensitive nature of the medical electronics also requires

that no obstacles, such as curbing, raised walkways, or planters, infringe on the access route. The vehicle will need to arrive at least half a day before it begins scanning patients and for some older units this period may be slightly longer. The estates department should ensure that all parking barriers blocking the access of the articulated vehicle to the hospital site are temporarily removed.

14.13 Arrangements may have to be made to ensure that the vehicle has access to the parking site out of core working hours of between 9 am and 5 pm. It is common for the supplying organisations to deliver the vehicles in the early evening in order that they set up in time for examinations to commence the following day.

14.14 If the mobile service is operated to supplement existing diagnostic services within a hospital, it may remain on site for approximately one to two days per week or two to three days every two weeks. The mobile unit will usually provide a service to number of hospitals within a region and visit each of these in turn. In the majority of circumstances, the same mobile vehicle will visit the hospital on each occasion. If the mobile unit is being used to provide a service during a breakdown or replacement, it is likely to remain on site until the process has been completed and the installed unit is operational.

14.15 Since mobile MRI units will require refilling with cryogen in order to operate, consideration may be required for allowing access of a much smaller vehicle delivering cryogen to the scanner. In addition, access arrangements may have to be made for movement of cryogen through hospital facilities.

Patient access considerations

14.16 The mobile unit will have only enough space for a control area, examination room and, if needed, a technical room. There will be no room for patient support areas, which will, therefore, have to be provided within the hospital.

14.17 The site selected should, in general, be close to the diagnostic imaging and interventional radiology department and/or an out-patient registration area. Convenient patient access from those areas to the unit should be considered, including ramps, elevators, walkways, and directness of routing. This access route should avoid, if possible, all non-patient areas of the hospital such as loading docks and storage areas. The provision of a temporary or permanent enclosed walkway between the hospital and the mobile scanner may be appropriate, particularly if the mobile service is to be provided intermittently over a long period of time. If it is considered necessary to move anaesthetised or sedated patients to the scanner, this will become a clinical requirement, and the planners should consult

with the hospital's clinical group leader on anaesthetics. In such cases, there will be a need to provide a recovery and patient preparation area close to the mobile unit in the main hospital building. It is strongly advised, if an enclosed walkway is not provided, that arrangements are made which enable patients, including those who may be in a wheelchair or trolley, to use the walkway safely all year round in all types of weather conditions.

Wheelchair access to the mobile unit

14.18 To allow passage of wheelchairs and stretchers, the pathway to the mobile unit should have no steps, curbs, or ramps with a slope greater than 1:12. Access to the actual scanner or articulated vehicle for the majority of ambulatory patients will be via a small staircase. The hospital, working with the supplying company, should ensure that a lift is provided at the entrance to the articulated vehicle to assist the access of patients on trolleys or in wheelchairs. Access by bed bound patients will not be possible and transfer to the mobile unit for these patients will be by trolley only.

Concrete support specification

14.19 The total weight of a mobile imaging system installed in the articulated vehicle when parked in the designated area will be of the order of 40,000kg or 40 metric tonnes. This may or may not include the towing vehicle. The area where the trailer is parked may have to be reinforced to take account of this large weight. In some instances, the roads leading into the designated site within the hospital grounds may have to be upgraded, particularly if the service is to be provided on a weekly or fortnightly basis for long periods of time.

Turning circles

14.20 Once the mobile vehicle has reached its designated site within the hospital, it will need to be manoeuvred into position. Therefore careful attention should be paid to the overall turning circle of the trailer. This is demonstrated in [Figure 14.2](#)

Vibration challenges

14.21 As stated in other sections of this guidance, the performance of the majority of diagnostic imaging equipment is susceptible to mechanical vibrations. The trailer of the vehicle should not be sited in areas where it may be susceptible to vibration from nearby moving vehicles, for example. Tolerances should be checked with the original equipment manufacturer of the diagnostic imaging equipment and the suppliers of the articulated vehicle.

Service supply pad

14.22 Electrical, data, water and communication services for the mobile vehicle system will need to be provided by the hospital infrastructure, as it is unlikely

that the unit will be able to operate without them. Consideration will need to be given as to the provision of a services pad and its location in relation to the hospital building and the mobile vehicle. The vehicle providers will wish to connect directly to the services pad and the type of connections required, service trunking and hospital supply points will need to be ascertained at an early planning stage. The services pad should be designed to be weather proof and incorporate a lockable cover to prevent unauthorised access. All service supplies to the mobile vehicle should be terminated in waterproof adaptors. The services required by the mobile vehicle units are described below.

SERVICE REQUIREMENTS

Electrical and earthing strategies

14.23 The electrical supply requirements for diagnostic imaging modalities installed in mobile articulated vehicles will be similar to their equivalents that are permanently installed as fixed or stationary modalities in a department. The mobile systems may require up to 30A and 480V per phase at 50 Hz in a WYE configuration with neutral and ground connections. Additional power supply requirements may have to be made for additional sockets in the mobile vehicle.

14.24 The mobile units will almost certainly have an earth reference terminal, which will need to be connected to the central protective earth of the hospital.

14.25 In all respects, the configuration should comply with 16th Edition of IEE wiring regulations, which are embodied in BS7671. Engineering tests advised for electrical supplies and earths to fixed units should also be carried out for mobile vehicle systems. Engineering requirements, [Appendix 2](#), contains further details.

14.26 All service supplies, particularly electrical connections to the mobile vehicle, must be terminated in high quality weatherproof and resistant adaptors. All services to the mobile vehicle should be placed in a locked cover to prevent unauthorised access.

14.27 In addition, electrical supplies will need to be provided for heating, lighting and ventilation of peripheral monitoring equipment. This should be kept separate from those provided for the imaging equipment. However, all equipment should be earthed through the common earth reference terminal.

Data and film communication links

14.28 In most cases, radiographers will wish to acquire and send data to and from the hospital information or patient administration system. These networks may, in turn, be linked with a RIS. To facilitate this requirement, low speed data communication links will be required between the mobile service vehicle and the hospital.

Appropriate firewalls and security mechanisms may have to be put in place to stop employees of the mobile vehicle provider accidentally accessing confidential data.

14.29 Images acquired from the mobile scanning equipment will usually be reported or reviewed by clinicians working in the hospital. The following options exist:

- a. the images may be dry laser printed using equipment located in the control area of the articulated vehicle. Arrangements should be made to ensure that films reach a radiologist and or referring clinician. A small sorting/collating area may need to be designated in the reception area associated with the mobile vehicle unit;
- b. if the hospital infrastructure permits, images may be transferred digitally to the radiology department and stored on a central or local archive. A high-speed data link with the hospital network, possibly with additional routers, may be required to facilitate this operational requirement.

Telephones

14.30 The customer must supply telephone services to the mobile imaging services vehicle whilst it is sited on hospital grounds. Usually, a modular phone jack should be supplied. A compatible receptacle should be located near the power receptacle and within 7.6 m of the unit's telephone receptacle. The connecting telephone cable is provided as a part of the mobile unit. Additional connections may need to be provided within the hospital telephone system to facilitate this requirement.

14.31 Maintenance of the scanner may still be undertaken by the original equipment manufacturer. As such, the mobile vehicle provider may request the provision of an additional phone connection to provide remote diagnostic services as described in Engineering requirements, [Appendix 2](#).

Water

14.32 General water services may need to be provided to enable people working within the mobile vehicle unit to wash their hands.

14.33 Some mobile vehicles may contain a rehumidification system, which uses water to maintain specified environmental requirements. Although the system has a storage tank, water should be available at each site for this purpose. System filling should be made available within reasonable distance of the unit site. The exact requirements should be discussed with the supplier of the mobile vehicle equipment.

SPECIAL CONSIDERATIONS FOR MRI SCANNERS

Chilled water supply

14.34 As for static or permanently installed MRI scanners, the hospital must provide a chilled water supply. This is used by the gradient coils and the compressor or chiller unit which recycles the liquid helium.

Medical emergencies

14.35 Local rules will usually prohibit resuscitation equipment containing ferromagnetic materials being taken into the examination room, as there is a distinct possibility that they may become dangerous projectiles. In addition, standard non-MRI compatible patient monitoring and/or emergency equipment such as ECGs, intravenous pumps, and defibrillators will not function properly in the magnetic field of the scan room. A patient experiencing distress may be removed from the scan room on a non-ferrous trolley (provided with the mobile unit) and attempts to resuscitate the patient will usually be undertaken in the control room. A protocol for resuscitation of patients following cardiac or respiratory arrest, for example, will be established. The resuscitation equipment will usually be stored within the control area. Therefore, part of the electrical supply to the articulated vehicle should be constantly maintained even during power failures.

Fire precautions

14.36 Because of the high magnetic field, fire response personnel must not enter the scan room with oxygen tanks, fire extinguisher or other fire fighting apparatus which is non-MRI compatible. As for fixed units, provision of MRI compatible fire equipment is necessary.

Maintenance and housekeeping

14.37 Because the magnetic field also has the potential to attract smaller ferrous items such as buckets, floor polishers, hand tools and tool kits, caution should be exercised by all maintenance and cleaning personnel entering the scan room.

Cryogen transfers

14.38 Consideration will need to be given to the route of cryogen transfer to the MRI unit. This may take the form of a small van being parked along side the trailer and then transferring Dewars of liquid helium to the articulated trailer using the integrated lift. Alternatively, arrangements may have to be made for Dewars of liquid helium to be transferred through hospital, usually out of core working hours.

Cryogen venting

14.39 The unit will include venting for the super conductive magnet. The liquid helium evaporates at a slow rate from the magnet at all times. The escaping helium gas is vented directly from the magnet to the exterior of the van. The ports of these vents are usually located high on the curb side (passenger side) exterior wall beside the magnet. The exhaust ports must not be obstructed at any time. The position of the exhaust vent with respect to the outside environment is critical and should not be located close to public, patient or staff areas, or placed where helium gas could enter hospital buildings. If the unit quenches accidentally or otherwise, large amounts of liquid helium may escape and displace the oxygen in surrounding still areas.

Magnetic fields

14.40 The quality of the images obtained from the MRI is directly dependent upon maintaining a constant homogeneous magnetic field within the system. The site must therefore be free of large ferrous objects and the scanner should not be located close to generators or buildings. The distances stated in the [Table 13.1](#) should be observed. The side of the vehicle unit should be sited at least 2 m away from the nearest building structure.

14.41 The fringe field generated by the magnet should not interfere with pacemakers or any other medical devices that may be present in the nearby hospital building. On the first visit to the site, following cryogen refilling and attainment of full magnetic field, a fringe field survey should be conducted to determine the extent of the fringe fields around the vehicle. In the majority of cases the 5 gauss field will be contained within the examination room within the vehicle. In some cases, particularly with older scanners, this may not be possible, resulting in a requirement to place barriers around the vehicle to control unauthorised access. This is a concern with patients who have pacemakers fitted. Planners should also try to ensure that the vehicle is not placed near any equipment that may be sensitive to fringe magnetic fields generated by the magnet. Equipment that is particularly sensitive to fringe magnetic fields includes modalities incorporating image intensifiers, gamma cameras and CR systems.

SPECIAL CONSIDERATIONS FOR MOBILE VEHICLE X-RAY, CT AND PET SCANNERS

Radiation protection

14.42 X-ray units provided in mobile vehicle units have to meet the same standards, in terms of clinical imaging performance and staff, patient and public safety, as those provided in fixed sites. The design of the trailer should incorporate some form of radiation shielding to contain the controlled radiation area within the examination room of the trailer. Some older units may not be able to meet the new requirements of the Ionising Radiations Regulations 1999, which has much stricter limits than earlier regulations on radiation exposure to the public from man-made sources of radiation. To combat this problem, additional physical barriers may need to be set up around the articulated trailer to prevent members of the public and staff from moving too close to the trailer whilst it is being used. In some cases, once the articulated trailers have been sited, the clinical procedure or operational space will be increased, thus preventing the need for additional physical barriers. Advice from the RPAs to the hospital and mobile vehicle supplier should be obtained regarding the measures that should be taken.

Cardiac angiography

14.43 For cardiac angiography or other interventional procedures undertaken in a mobile vehicle, a temporary or permanent covered walkway must be provided between the day ward or recovery preparation area in the hospital. Often, seriously ill patients or those still recovering from the effects of sedation or anaesthesia will need to be transferred to and from the mobile vehicle. Advice from the clinical lead on anaesthesia should be acquired when designing the walkway and its connections with the hospital and the mobile vehicle.

15 Ancillary patient accommodation

RECEPTION AREAS

15.1 The reception and waiting areas will provide the patients' and carers' first contact with the facility. It is important not to miss the opportunity to provide a reception that warmly greets all those who enter, provoking a feeling of support and reassurance, balanced with a sense of efficiency.

15.2 A well-designed reception, with friendly staff and well-managed appointments, will help to reduce stress to both patients and staff. The benefits of good interior and environmental design have been well researched and documented.

15.3 The central reception/appointments area is the focal point of the imaging services department, and should be designed to serve the whole department. Consideration should be given to the provision of separate sub-reception areas for specific individual modalities, in particular cross sectional imaging. Particular care should be taken to ensure that access to sub-reception/waiting areas is well facilitated for all patient groups, including the disabled, so that the patient's initial experience reflects the focus on patient care. Patients should report their arrival to the central reception, as it is desirable for patients' records to be centrally managed, with identity and attendance details recorded here, so that information on the next part of the patient's care can be confirmed.

15.4 There should be a counter for registration and appointment procedures, with a separate section with auditory privacy provided, to allow for confidential discussions. The counter should be of split level design to accommodate the appropriate RIS terminals to schedule and confirm attendance of patients. Individual project teams will need to consider the design of the counter from the perspective of security, disabled accessibility and the age of the patients attending for the majority of the procedures.

15.5 In its consideration of the design of the reception desk and the staff area behind it, the local project team will need to take into account local staffing requirements. Staff working in the main reception area will need to have a good view of the main waiting area in the department. The use of CCTV may be appropriate for security reasons.

15.6 Provision may need to be made for temporary storage of X-ray films within the reception area, but this requirement will reduce with the increased integration of digital imaging.

15.7 If geographical considerations require provision for a subsidiary reception point, computer linking is essential. This should be achieved by the use of the RIS. A workstation for a senior radiographer should also be provided in this area, for workflow pattern control, technical enquiries and general supervision.

PATIENT JOURNEYS

15.8 Please refer to the text under individual modalities.

WAITING AREAS

15.9 The main waiting space for all patients and their companions should be controlled by and overseen from the central reception area, whilst being easily accessible from the entrance to the department. It should have a comfortable and relaxing environment with domestic type finishes and fittings. Natural light should be provided where possible and consideration may need to be given to mechanical ventilation. If it is considered that there may be excessive build-up of heat in the main waiting area, comfort cooling or, preferably, air conditioning should be considered. Patients who have received an administration of a radioactive substance for unsealed source imaging should be asked to wait in the appropriate sub-waiting area.

15.10 Where the facility expects to examine a relatively high proportion of children, play areas should be allocated within the main waiting area. Separate facilities should be provided for younger children and teenagers or adolescents. Local circumstances may dictate that segregation of patients is appropriate.

15.11 Another waiting area, separate from the others, should be provided for patients on beds or trolleys. In this area circulation space will be required for nurses or others attending the patient. Space should also be allowed for any additional equipment that may be attached to the trolleys. This area may be a recess off the relevant circulation space and should be observable from the reception point. The use of curtains should be provided for privacy when required.

15.12 Patients awaiting examinations or subsequent checks should be provided with sub-waiting spaces, convenient for the diagnostic rooms. The provision of sub-waiting areas is different for each modality and is described within each modality section of this guidance.

15.13 Space will need to be available for use outside normal working hours, for patients attending the department from A&E. There may be a need to accommodate patients on trolleys during those times. This will depend on the provision of A&E diagnostic imaging facilities, which may be located outside the main department.

Disabled people

15.14 It is essential to ensure that an accessible environment is provided for people who have problems with mobility and orientation. This includes wheelchair users, those who have difficulty in walking and those with a sensory handicap, such as a visual or hearing impairment. Please refer to the Disability Discrimination Act 1995 for further information.

SEPARATE MALE AND FEMALE CHANGING AREAS – CHANGING CUBICLES

15.15 Cubicles should be planned to be in groups and associated with sub-waiting areas. They should provide facilities for patients to dress and undress in privacy and for secure storage of clothing during their examination. Separate administrative arrangements should be made for the safety of valuables. Cubicles should have some means of identification, for example numbering or colour-coding, both inside and out. At least one of the cubicles in each group should be suitable for use by patients who require assistance. For any special considerations, please see sections under individual modalities.

15.16 Mirrors and shelves should be fixed at heights suitable for both wheelchair and standing users. Shelves should be placed near mirrors.

COUNSELLING AND PRIVATE CONSULTATION ROOMS

15.17 Counselling and psychological care will be required at some stages of the care and diagnostic process. There is a growing need for facilities that allow private discussion with patients at some stages of the diagnosis. This may be of particular importance in the care of patients undergoing treatment for cardiological disease or cancer.

15.18 Where indicated in the sections on individual modalities, dedicated accommodation should be provided for patient counselling. Ideally, the environment, wherever practicable, should reflect the informal atmosphere needed to deal with seriously ill or

distressed patients or visitors. Counselling facilities in particular should display these qualities, and care should be taken with the quality of finishes, colour and lighting to provide an informal, comfortable, sympathetic environment. Overall, the room should be comfortable, domestically furnished and incorporate acoustic shielding, so that conversations with the counsellor or clinician cannot be overheard in adjacent areas. The rooms should incorporate some rudimentary refreshment facilities, be large enough to seat a maximum of four people comfortably (a nurse, clinician, patient and relative, for example) and positioned appropriately either within an imaging services department or close to the modality, possibly next to the ultrasound suite.

15.19 There should be a discreet exit from a consultation room so that patients who have received bad news do not have to pass through the main waiting area.

15.20 Project teams should determine the number and location of counselling rooms, depending on local operational and clinical policies.

PATIENT ENTERTAINMENT AND REFRESHMENT FACILITIES

15.21 In the main and sub-waiting areas, consideration should be given to the provision of chilled water, together with a supply of paper cups. A separate bin should be provided for the used cups so that they can be collected for recycling. This is provided free of charge to patients and visitors.

15.22 In large diagnostic facilities, such as those provided in some district general and tertiary hospitals, where there is a large throughput of patients, space may be allocated for a small coffee shop, such as those provided by Friends and charitable organisations.

15.24 Waiting areas for patients should contain magazines and, possibly, a wall mounted television. This could be a stand-alone device, or be connected to the hospital's own internal television system that is provided to inpatients.

16 Staff and special activity accommodation

OFFICE ACCOMMODATION

16.1 An office with standard facilities is required (see Health Building Note 18, 'Office accommodation in health buildings') to suit the staffing requirements for each department. Local teams will assess the numbers and type.

16.2 In general terms, the office and general accommodation of a diagnostic imaging department does not differ greatly from that of other hospital based facilities of comparable size. However, a number of points requiring special care do arise:

- offices used for sensitive discussions with seriously ill patients and their relatives require careful siting. There is a need for discretion in terms of sound control, use of induction loop hearing aids, and of access/departure;
- to assist in advancing patient services, most departments are engaged in a range of clinical trials working with other clinical specialities. There may be special office needs in accommodating staff with roles such as record keeping and data analysis;
- the National Cancer Registry is an intrinsic part of the drive towards better cancer outcomes and, like the clinical trials, endeavours may give rise to the need for temporary or permanent accommodation of a high level clerical team;
- the introduction of new technologies which better combine and handle patient treatment data, particularly in diagnostic imaging, has given rise to the need for data entry and review facilities for use by radiographers and other key staff. These may be accommodated in an open plan office suite;
- office accommodation for those responsible for psychological and social care of the patient and families may be required. These must include open access rooms for patient information services.

SUPERINTENDENT/SENIOR RADIOGRAPHER ACCOMMODATION

16.3 Dedicated offices for superintendents and shared offices for senior radiographers should be provided.

16.4 In any radiology facility, there will be one or more superintendent or, in some cases, senior radiographer with administrative and departmental responsibilities. Each will require office accommodation. Functional requirements will dictate the best location for these offices. They will be used for viewing of and reporting on diagnostic images, appraisals, consultations, and discussions with colleagues and other personnel.

16.5 This office or offices should be provided with dimmer light switches to facilitate the above requirements. There will need to be a storage space for the records on administration, maintenance, radiation protection, and space for books, periodicals and images of special interest and education. In addition to conventional illuminators, electronic image viewers may be required. The administrative work (including staff records and that of radiation protection) will require a RIS terminal with easy access to a printer. The confidential nature of some of the printouts will make it helpful for the printer to be in the room, where it will need to be silent. An additional multi-monitor workstation may be required for reporting purposes.

16.6 As mentioned above, the offices may be used to conduct staff appraisals or discuss other sensitive issues. If these rooms are to be placed near waiting or processing areas, consideration should be given to providing some form of acoustic shielding.

EDUCATION FACILITIES

16.7 The widespread increase in the sophistication of approach to diagnostic imaging and interventional radiology, and the need for continuing professional development, has placed an increasing emphasis on education facilities. The pace of technological and clinical development in radiological techniques is extremely fast.

16.8 The clear need for an educational seminar or lecture room with modern audio/visual facilities and good computer systems access is now well established. In order to promote effective use, this should be located close to the patient care areas.

16.9 Library facilities and internet access points are key to modern radiology services. It is essential to consider

the provision of private study space, to make effective use of publications.

16.10 Many diagnostic imaging departments have specialist staff training facilities for the basic and postgraduate education of staff members such as radiographers and physiotherapists. Design details are beyond the scope of this guidance.

STAFF LOCATION SYSTEM

16.11 The staff location system employed in the hospital should be extended to give adequate cover to this department.

TELEPHONES AND INTERCOM SYSTEMS

Telephones

16.12 Central telephone facilities for internal and external calls should be provided. In recovery areas or adjacent to them, and in any diagnostic imaging control rooms in which a telephone is provided, they should be fitted with an indicating call-light and a bell or buzzer of subdued tone. Additional lines may need to be provided for remote diagnostic access of computer workstations and consoles.

16.13 In some diagnostic rooms, particularly those used for interventional work, it may not be appropriate to install a telephone, as this may distract the clinician when conducting difficult procedures. In these instances, a staff call and or cardiac/respiratory arrest alert system should be provided.

16.14 Guidance concerning the provision of telephone systems and equipment, including the telephone internal cabling distribution and telephone handsets, is given in Health Building Note 48, 'Telephone services'.

Intercom systems

16.15 A telephone system served by electronic exchange equipment should meet virtually all the internal communication requirements in this accommodation. However, due to the character and nature of some of the facilities, it is usual to provide intercom stations controlled from the departmental reception point. This will permit "hands-free" speech contact between the receptionist and diagnostic staff in these rooms. These stations should be of the "duplex" type, with microphone and loudspeaker combined in a telephone-type instrument, with automatic voice switching and automatically convertible to "telephone mode" for privacy. The system should provide a minimum of two speech channels and incorporate all call paging.

16.16 In those situations where certain imaging rooms are associated with accident and emergency facilities, it

may be appropriate to install an extension from the departmental intercom system.

CLOCKS

16.17 Clocks, which should be battery operated, should be located only where they can be viewed by numbers of staff/patients/visitors.

AUXILIARY AREAS FOR CLEAN AND DIRTY UTILITY, TROLLEY LAY-UP AND ASSOCIATED NURSING FUNCTIONS

Dirty utility

16.18 There should be space for the temporary holding of materials for disposal and reprocessing, for example soiled linen for the laundry and any items for central cleaning.

16.19 Special consideration should be given to the provision of a slop hopper with adequate drainage, to avoid clogging by barium. Special drainage must be provided for the disposal of barium. A bedpan washer unit or macerator, depending on hospital policy, will also be required.

16.20 These facilities should, if possible, be accessible from within the department and also close to the hospital street. Collections, except for sharps containers, which are held in the dirty utility room for security reasons, may then be made without portering staff needing to enter the main circulation space of the department.

16.21 Bagged refuse, used linen, and possibly sterile supply service items for reprocessing are held for collection. The disposal hold should be subdivided so that each category may be held separately, thus lessening the risk that recyclable items are sent for incineration.

16.22 The size of the disposal hold should be determined by the ratio of the rate of accumulation of material for disposal, to the frequency of collection.

16.23 Consideration should be given to the method of disposal of catheters and stents used in interventional radiology procedures.

Linen store

16.24 The provision of storage for the day-to-day working stock of linen will be required. Its size and function will be in accordance with the whole hospital policy.

Cleaners' room

16.25 A cleaners' room to service the department should be provided.

Secure storage areas

16.26 Secure storage should be provided to house small items of equipment used intermittently, for example instrument trolleys. Space will also be required for bulk storage of forms, stationery and small miscellaneous items. Storage for wheelchairs and patient trolleys will be a matter for local decision. Where there are specialist requirements, this is highlighted in sections on individual modalities.

Clean utility

16.27 Clean utility room(s) should be provided for the storage and assembly of clinical requisites used in the imaging and interventional rooms. These may include sterile supply items, pharmacy supplies including drugs, controlled drugs, contrast media, and other non-sterile clinical supplies. Certain pharmaceuticals used during barium examinations may also be stored and prepared in this area. Space will be required for trolleys to be "laid up" for all special examinations. The provisions necessary for the out-of-hours access to controlled drugs will have to be considered.

PATIENT CALL SYSTEMS

16.28 Patient/staff call points should be provided in all patient toilets and changing/recovery rooms. Each call unit should comprise a push-button or pull cord, reassurance lamp and reset switch.

16.29 Call units should generally comprise a switch (pull to call, push to reset) and reassurance lamp. The audible alarm signal initiated by patients should operate for one second at ten-second intervals until cancelled with corresponding lamps lit continuously. The audible alarm signal initiated by staff should operate intermittently at half-second intervals, with corresponding lamps flashing on and off at the same rate.

16.30 A visual and audible indication of operation should be provided at the nurse base and repeated at the main reception point, to give responding staff unambiguous identification of the call source. For use outside normal working hours, switching should be provided to transfer indication of an emergency call to the accident and emergency department or to an appropriate centrally manned point.

STAFF EMERGENCY CALL SYSTEMS

16.31 Staff/staff (emergency) call points should be provided in all patient toilets, changing rooms, recovery rooms, imaging control and examination rooms, and waiting areas. Consideration should be given to the provision of personal alarm facilities for all staff.

16.32 All call systems should operate at extra-low voltage. Further general guidance is given in Health Technical Memorandum 2015, 'Bedhead services'.

STAFF REST ROOMS

16.33 A staff room will be required for general use by all staff of the department. Ideally, it should be sited near to diagnostic imaging rooms, particularly those used outside normal working hours. It is desirable that the room should have natural lighting and ventilation and a pleasant environment. As this room will be used 24 hours a day, the provision would be useful so that staff working at night can rest. Facilities for beverage making and preparation of snacks are required.

STAFF CHANGING ROOMS INCLUDING SURGICAL SCRUB, SHOWER AND WC FACILITIES

16.34 Separate changing rooms should be provided for male and female radiographers. All should have full height lockers for the storage of personal clothing, uniforms and personal items. Special facilities are required for those departments undertaking interventional work.

ON-CALL/NIGHT DUTY RADIOGRAPHER FACILITIES

16.35 Dedicated provision should be made for on-call clinical staff. This should comprise a bed/sitting room with tea and coffee making facilities, TV and music facilities, internal telephone, intercom and computer terminal for private study. An en-suite shower room should also be provided. Local circumstances will dictate the number of these suites required.

PORTERS' BASE

16.36 Accommodation for porters, also capable of being overseen from reception, should be provided near the entrance to the department.

Appendix 1 Example plans

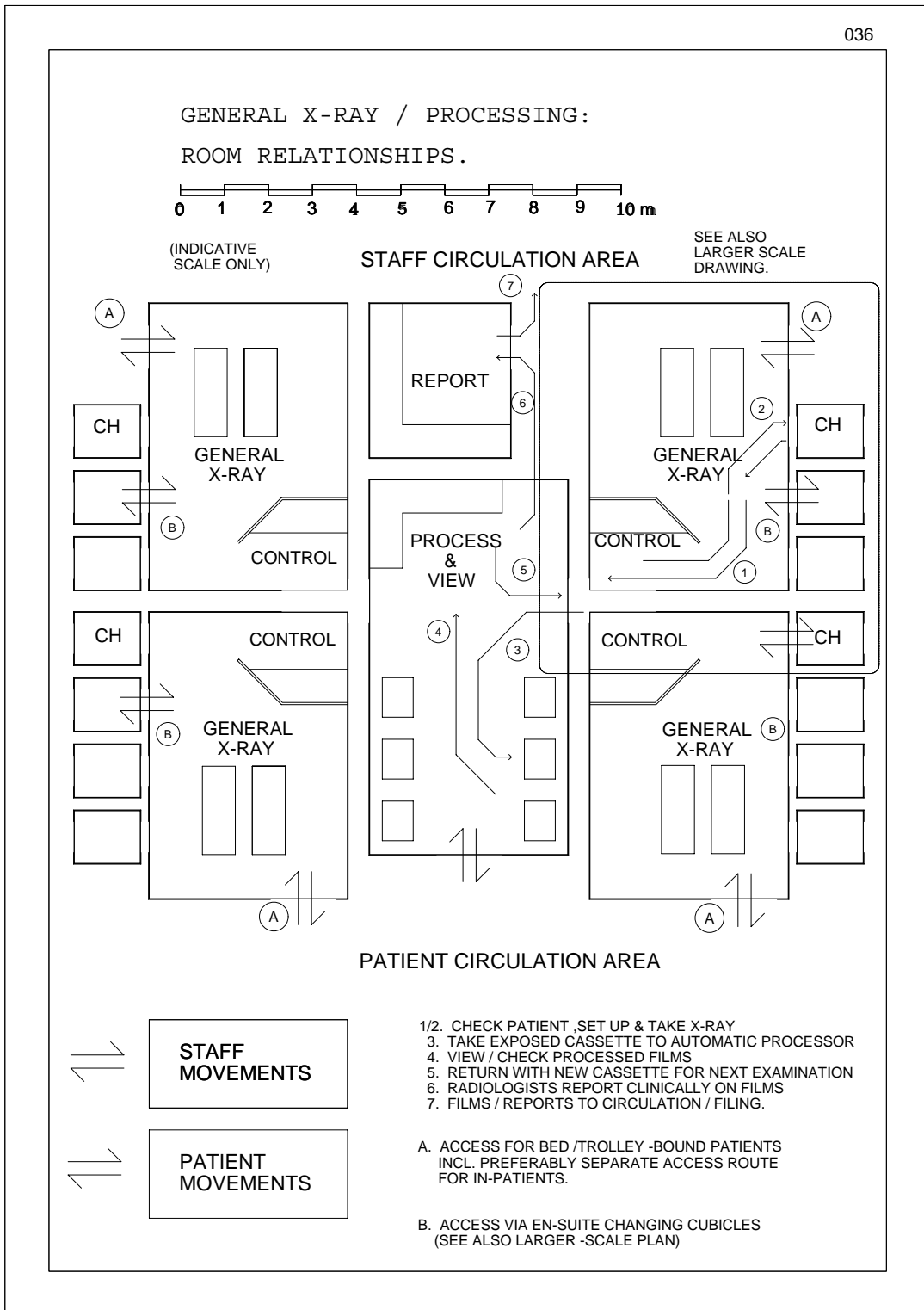

GENERAL X-RAY/CHANGING/
 PROCESSING : ROOM RELATIONSHIPS
 (OPTION SHOWING EN-SUITE CHANGE)

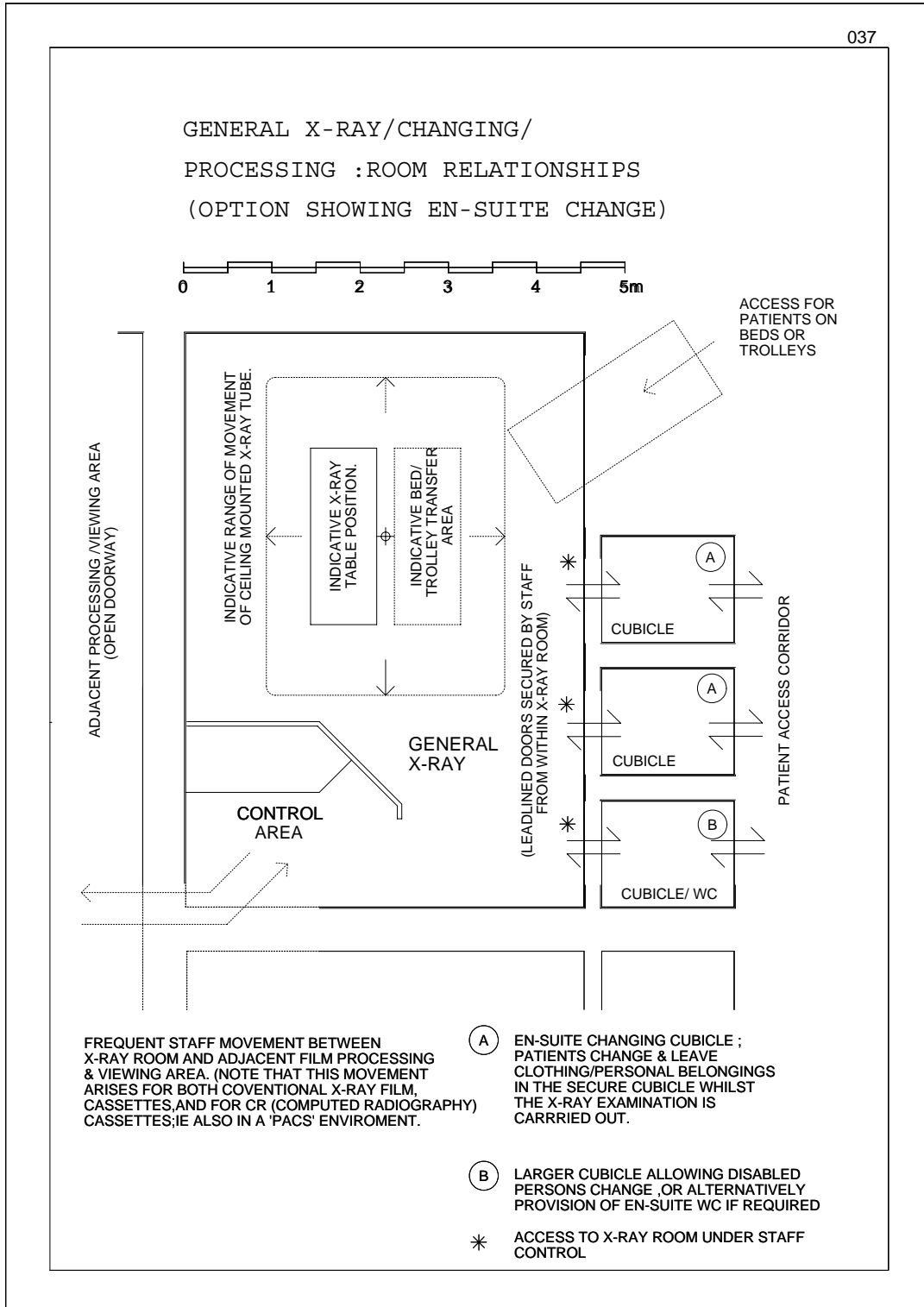

039

**PROCESSING AND VIEWING AREA (1):
INDICATIVE ARRANGEMENT FOR SMALLER DGH
USING AUTOMATIC DAYLIGHT FILM PROCESSORS.**

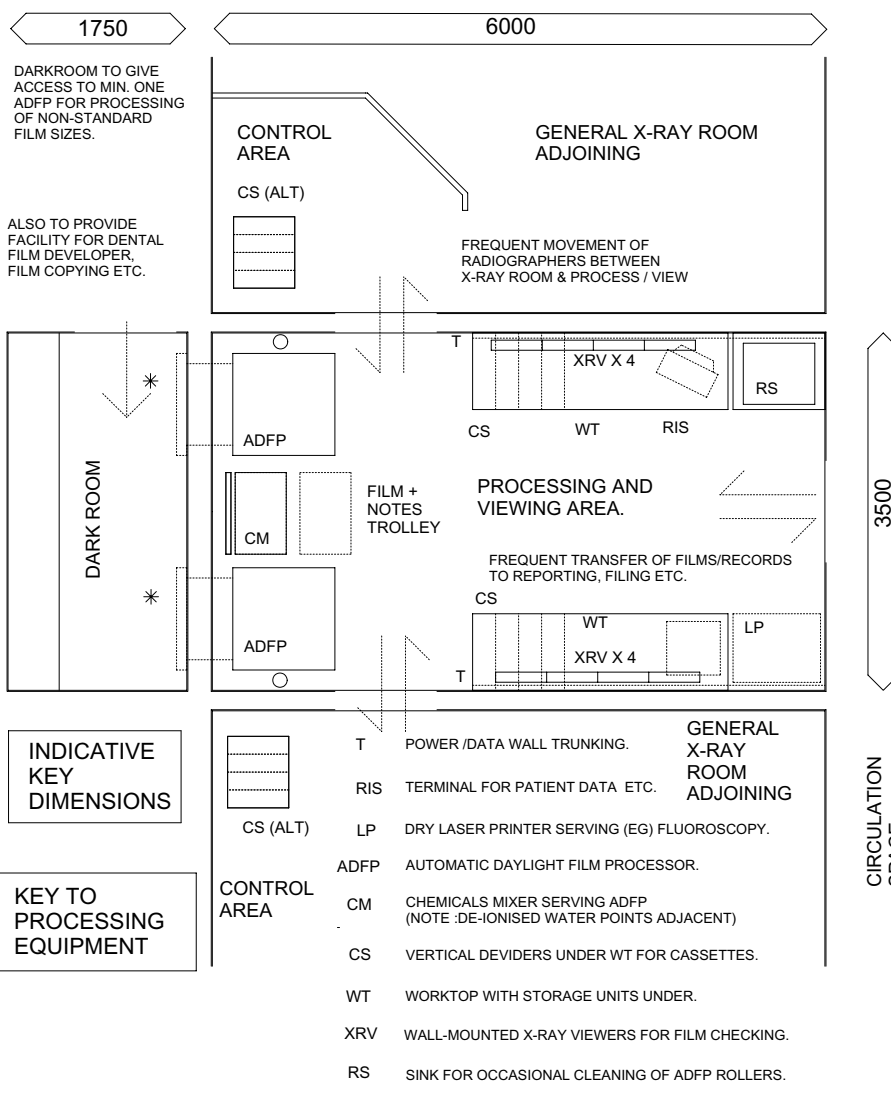
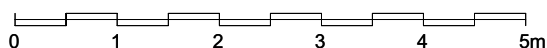

**PROCESSING AND VIEWING AREA (3):
INDICATIVE ARRANGEMENT FOR LARGER DGH
USING COMPUTED RADIOGRAPHY (CR),
POSSIBLY WITH 'PACS'**

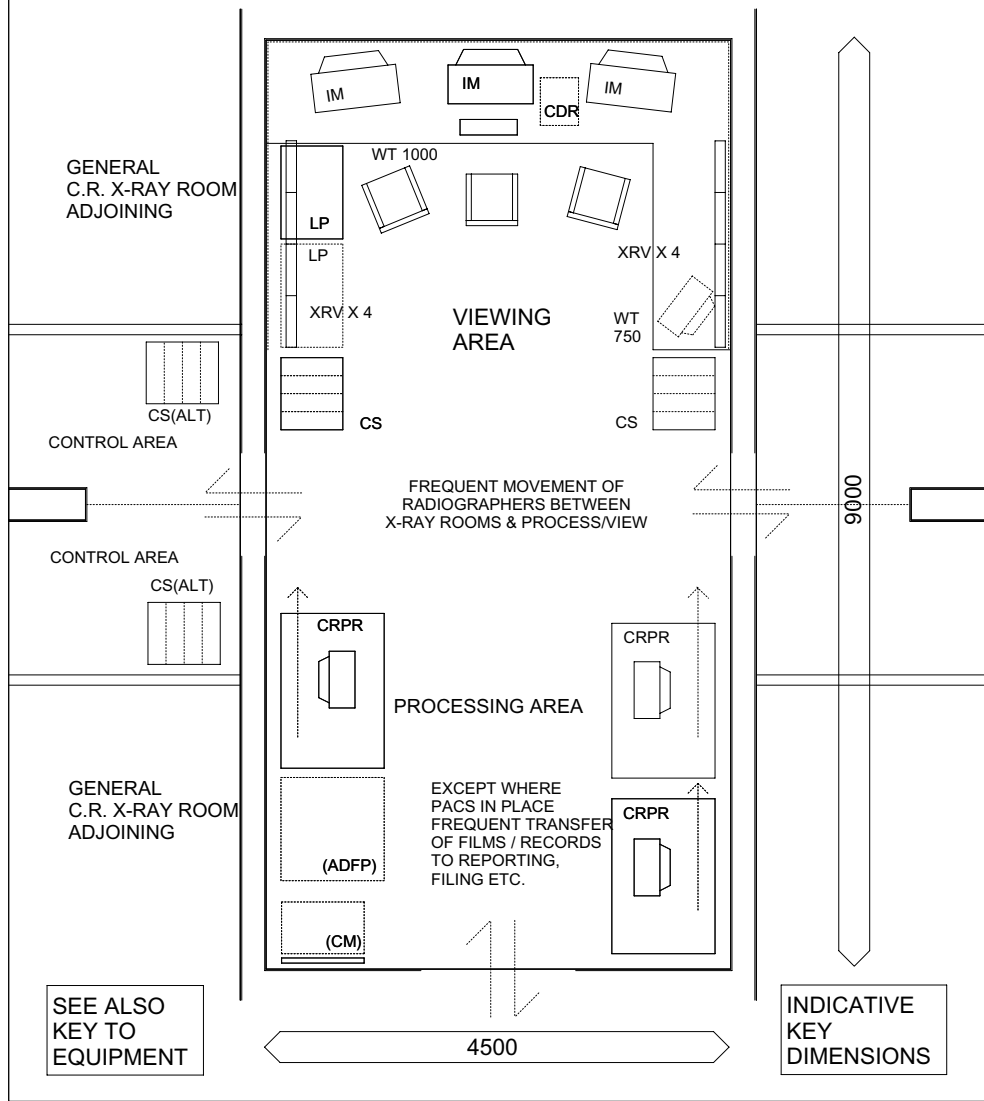
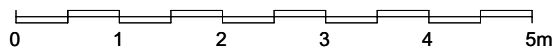

040A

COMPUTED RADIOGRAPHY (C.R.)

KEY TO EQUIPMENT

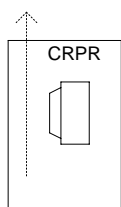
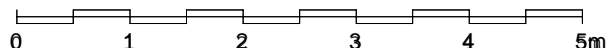

CRPR
 COMPUTED RADIOGRAPHY PLATE READER
 -SCANS RE-USABLE C.R. PLATES DIGITALLY
 -DIGITAL IMAGE DATA SEND TO IMAGING MONITORS FOR INITIAL VIEWING OF DIAGNOSTIC IMAGE
 -MAY INCORPORATE BUILT-IN MONITOR
 -LINKED TO PATIENT DATA INPUT (RIS SYSTEM)

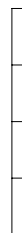

XRV X 4
 WALL MOUNTED X-RAY VIEWER AS BACKUP & FOR VIEWING ARCHIVE FILM ETC.



(ADFP)
 SPACE FOR AUTOMATIC DAYLIGHT FILM PROCESSOR, POSSIBLY RETAINED AS BACKUP OR DURING TRANSFER PERIOD.

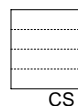

CS
 VERTICAL DIVIDER STORAGE FOR CASSETTES/PLATES



(CM)
 CHEMICAL MIXER SERVING ADFP : INCLUDING DE-IONISED WATER SUPPLY.

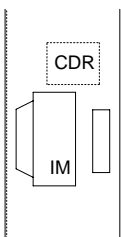

CDR
IM
 IMAGING MONITOR ON DEEP WORKTOP : FOR INITIAL VIEWING /CHECKING OF DIAGNOSTIC IMAGE.

WT 1000

DEEP WORKTOP FOR IMAGE MONITORS

POWER /DATA TRUNKING

CD WRITER IF REQUIRED FOR ARCHIVE RECORD OF IMAGES (NON-PACS)

WT 750

STANDARD WORKTOP WITH STORAGE UNDER.

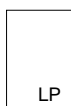

LP
 LASER PRINTER FOR HARDCOPY IMAGES (INCLUDING AS BACK-UP PROVISION IN PACS)

KEY TO PROCESSING ETC EQUIPMENT.

RELATIONSHIP BETWEEN DIAGNOSTIC IMAGING
& PATIENT WAITING /CHANGING FACILITIES:
ALTERNATIVE MODELS.

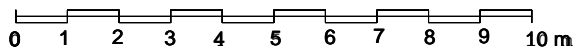

(SCALE INDICATIVE ONLY)

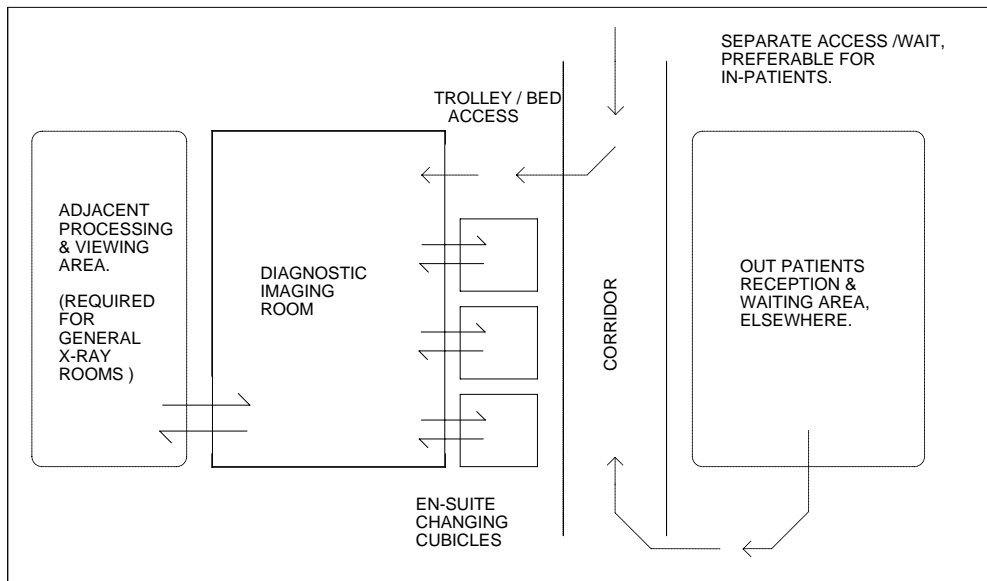
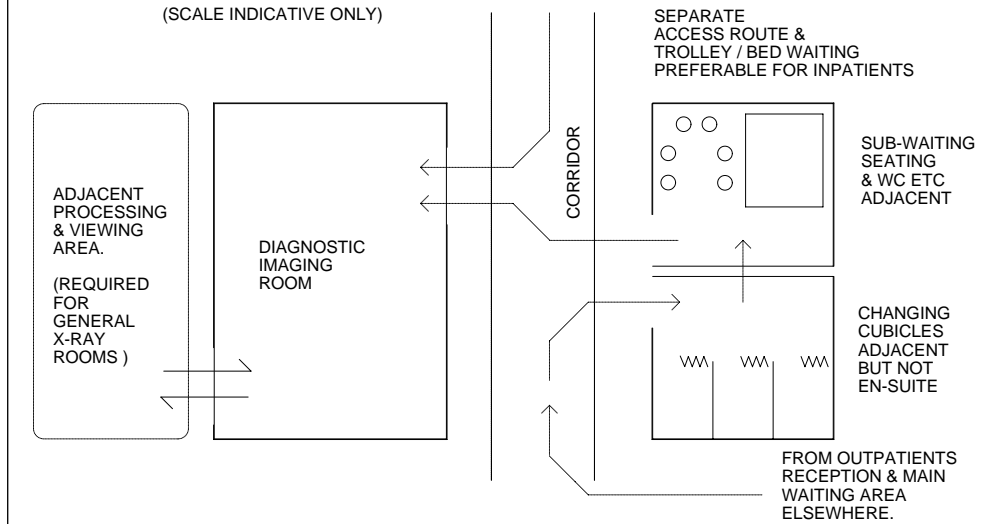

001

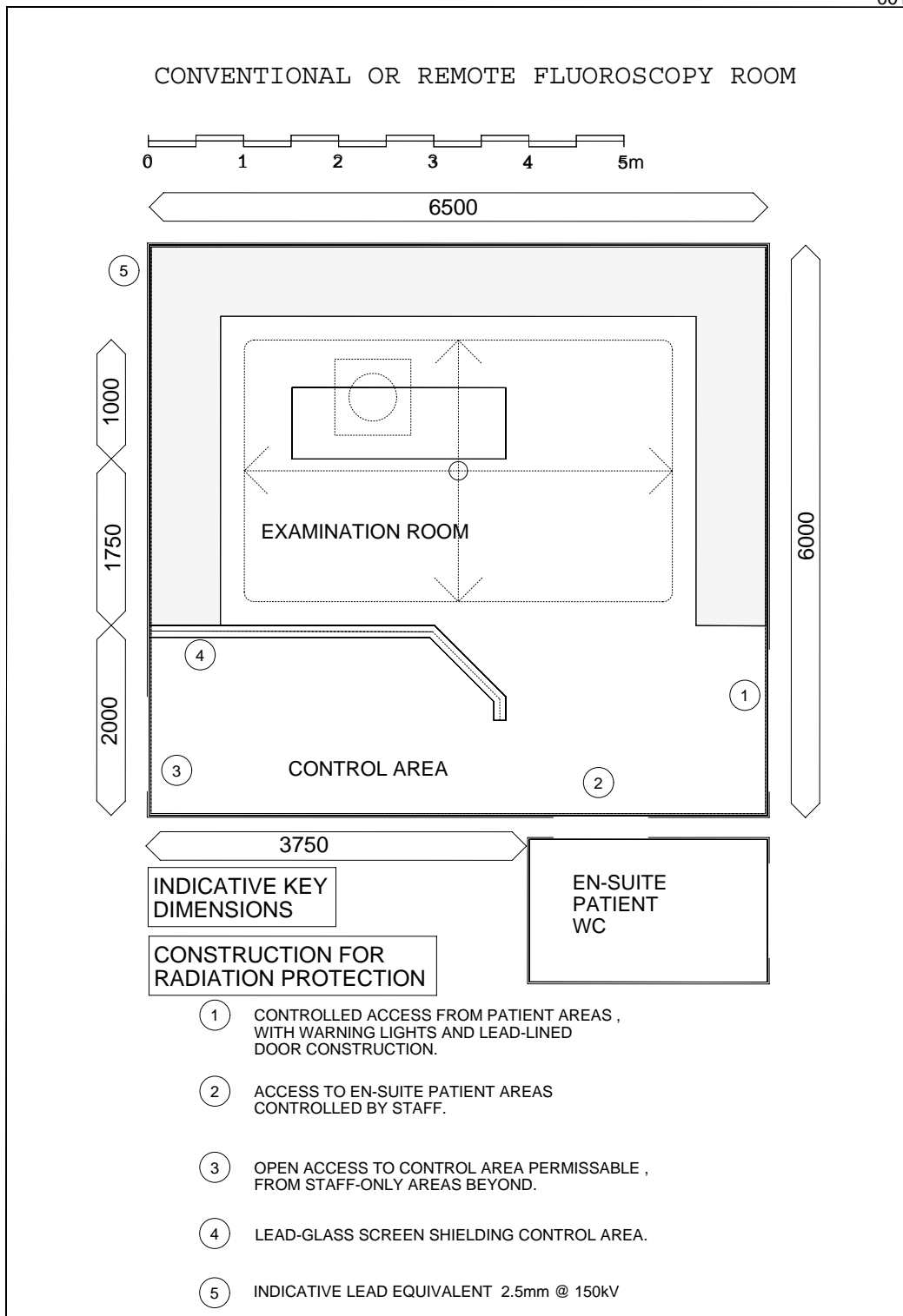

003

FLUOROSCOPY ROOM : KEY TO EQUIPMENT.

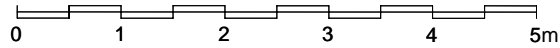

FREE STANDING EQUIPMENT CABINETS FOR TRANSFORMER , X-RAY GENERATOR, CONTROLS ETC.

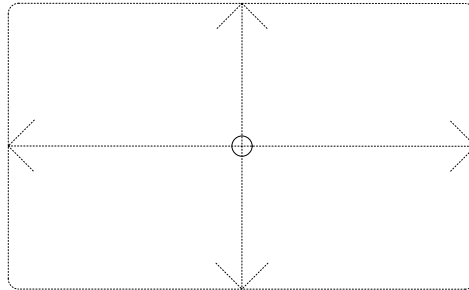

INDICATIVE RANGE OF MOVEMENT OF X-RAY TUBE MOUNTED ON CEILING TRACK SYSTEM.

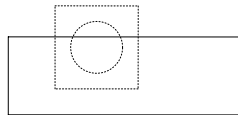

ADJUSTABLE X-RAY TABLE WITH FLOOR-MOUNTED FLUOROSCOPY 'U-ARM' X-RAY TUBE "EXPLORATOR" OVER.

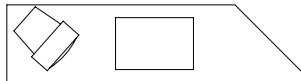

X-RAY CONTROLS AND MONITOR, BEHIND LEAD-GLASS SCREEN.



TROLLEY MOUNTED IMAGE MONITOR (ALTERNATIVELY, IMAGE MONITORS MAY BE CEILING-SUSPENDED AND MOBILE ON A CEILING TRACK SYSTEM)



CHEST STAND:(NON-BUCKY TYPE) IS COMMONLY INSTALLED IN ROOMS GENERALLY USED FOR FLUOROSCOPY PROCEDURES.CONTROLS ARE INTEGRAL WITH CHEST STAND.



EMERGENCY STOP CONTROLS

KEY TO DIAGNOSTIC IMAGING EQUIPMENT

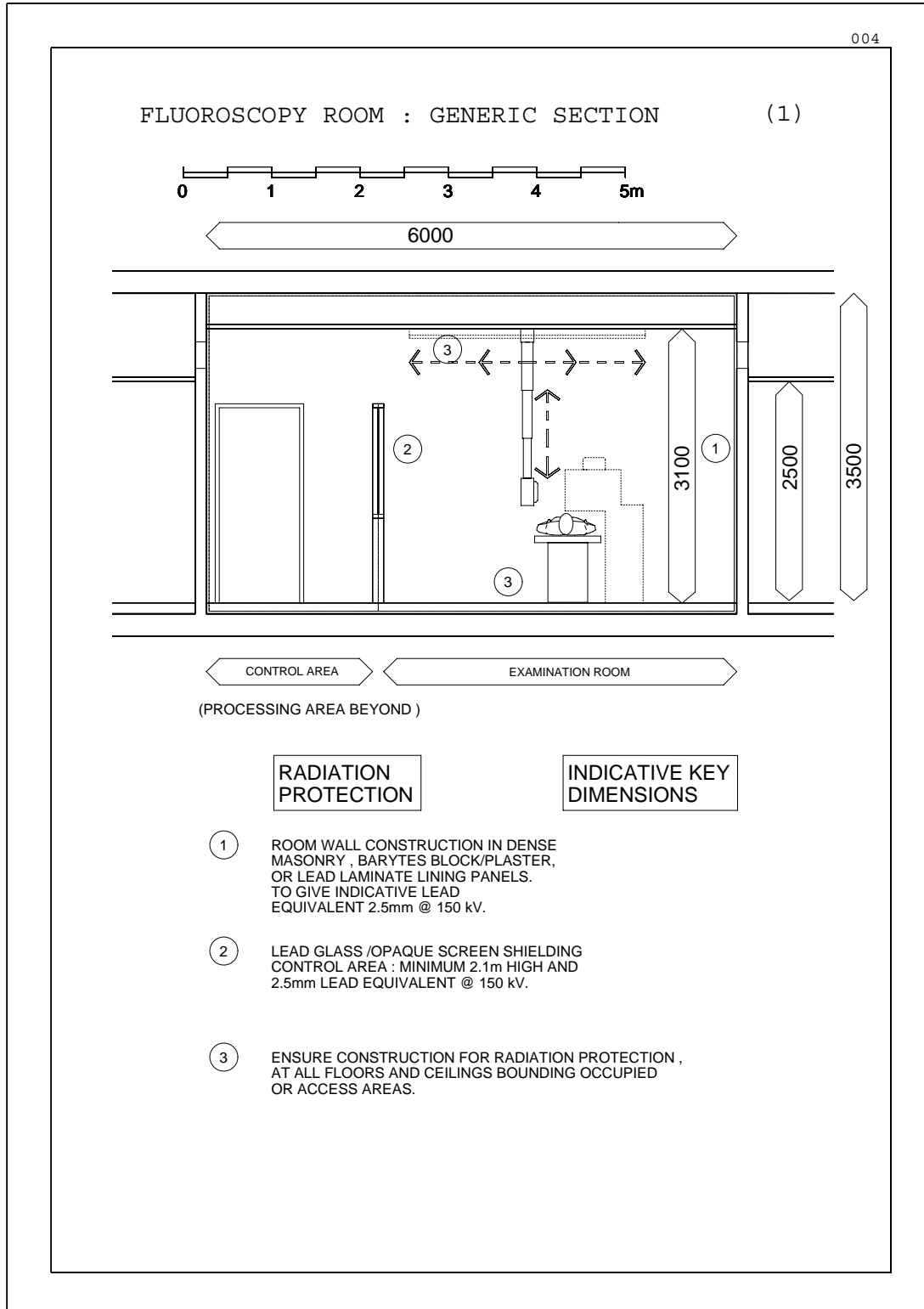

005

FLUOROSCOPY ROOM : GENERIC SECTION (2)

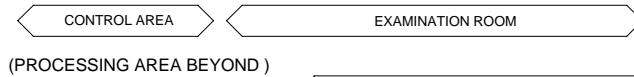
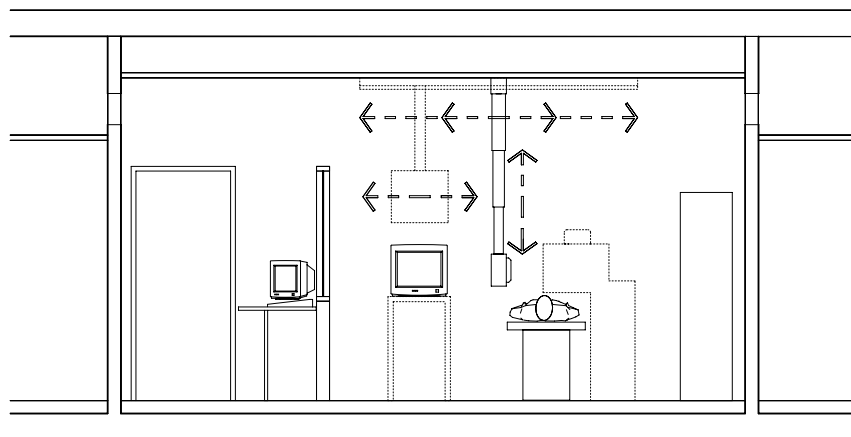
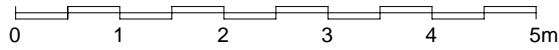

DIAGNOSTIC IMAGING EQUIPMENT

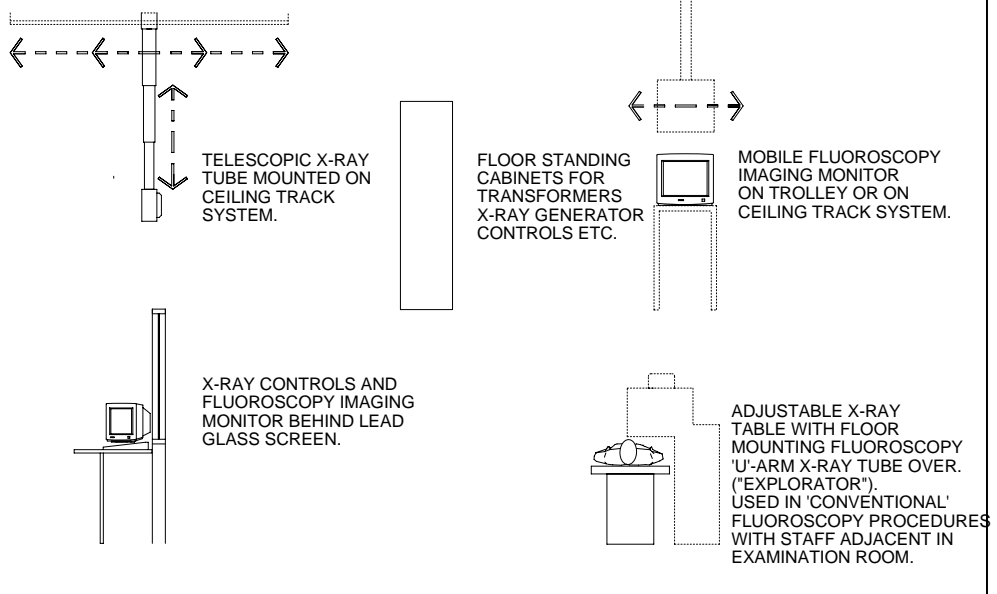

FLUOROSCOPY ROOM : GENERIC SECTION (3)

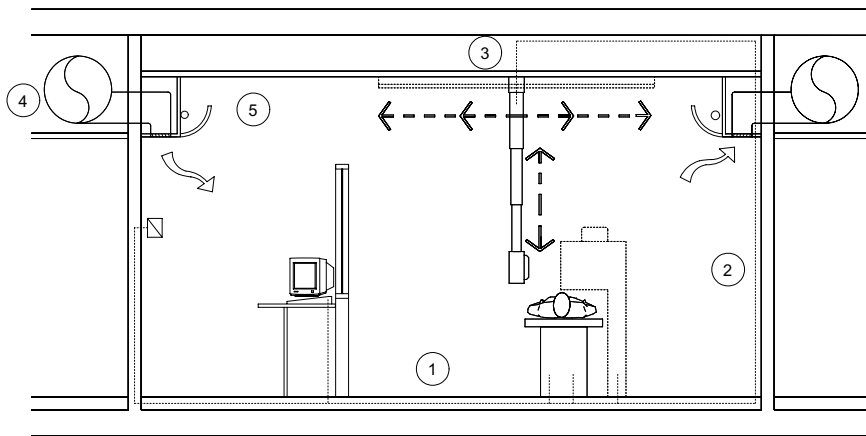
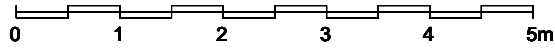

ENVIRONMENTAL SERVICES AND CABLE DISTRIBUTION

- ① POWER , CONTROL AND IMAGE DATA,CABLE DISTRIBUTION BETWEEN CONTROL AREA , X-RAY TABLE ,FLUOROSCOPY U-TUBE AND CABINETS :MINIMUM 75mm TRUNKING WITHIN FLOOR SCREED.
- ② VERTICAL CABLE DISTRIBUTION IN WALL-FIXED SURFACE TRUNKING OR CONCEALED WITHIN HOLLOW PARTITION.
- ③ CABLE DISTRIBUTION TO CEILING SUSPENDED X-RAY TUBE ABOVE DEMOUNTABLE CEILING . (NOTE POSSIBLY LIMITED SERVICE VOID DICTATED BY 3.1m CLEAR ROOM HEIGHT.)
- ④ MAJOR VENTILATION DUCTWORK ACCOMMODATED WITHIN DEEPER CEILING VOIDS IN ADJACENT AREAS.
- ⑤ PERIMETER VENTILATION GRILLES COMBINED WITH INDIRECT LIGHTING:LAID OUT TO AVOID RANGE OF MOVEMENT OF CEILING -MOUNTED X-RAY TUBE.

041

ANGIOGRAPHY /
 OCCASIONAL VASCULAR INTERVENTION (1)
 -DISTRICT GENERAL HOSPITAL CONTEXT:
 INDICATIVE ROOM RELATIONSHIPS.

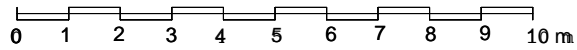

(INDICATIVE SCALE ONLY)

(SEE ALSO LARGER-SCALE PLAN)

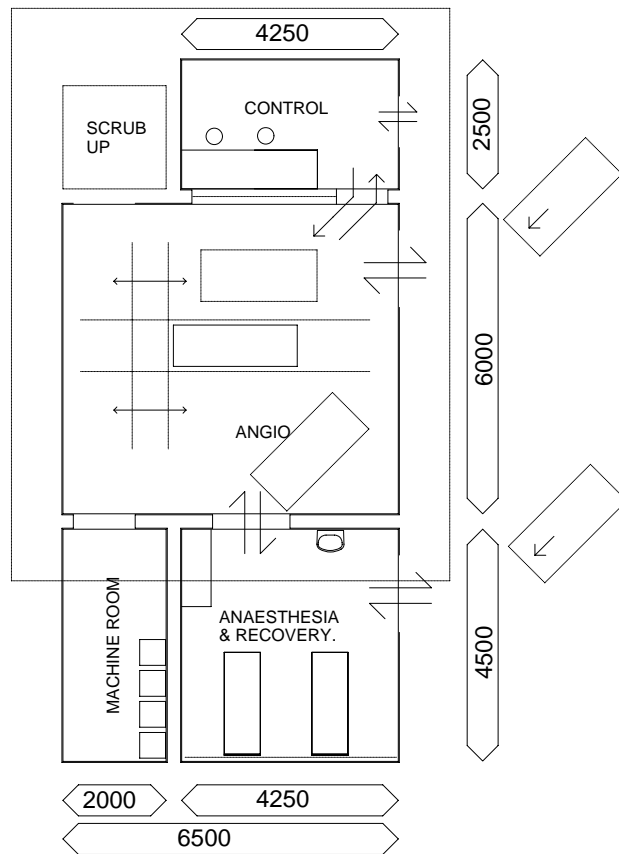

ANGIOGRAPHY / VASCULAR INTERVENTION (2)
 INDICATIVE ROOM RELATIONSHIPS FOR
 TWIN-ROOM SUITE.

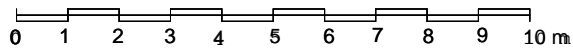

(INDICATIVE SCALE ONLY)

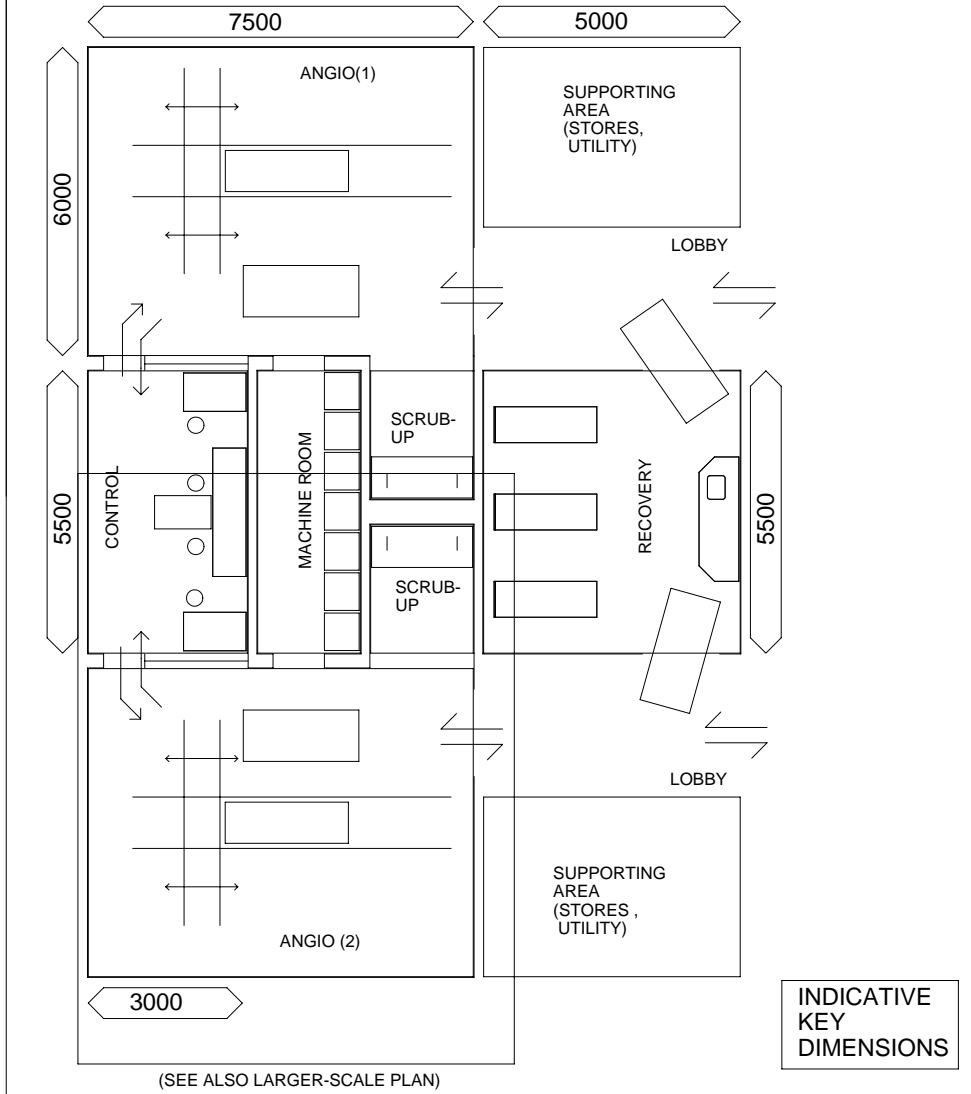

025

MAJOR VASCULAR INTERVENTIONAL
PROCEDURES SUITE : MOVEMENT DIAGRAM.

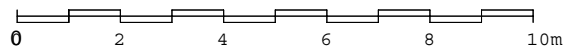

(Indicative Scale Only)

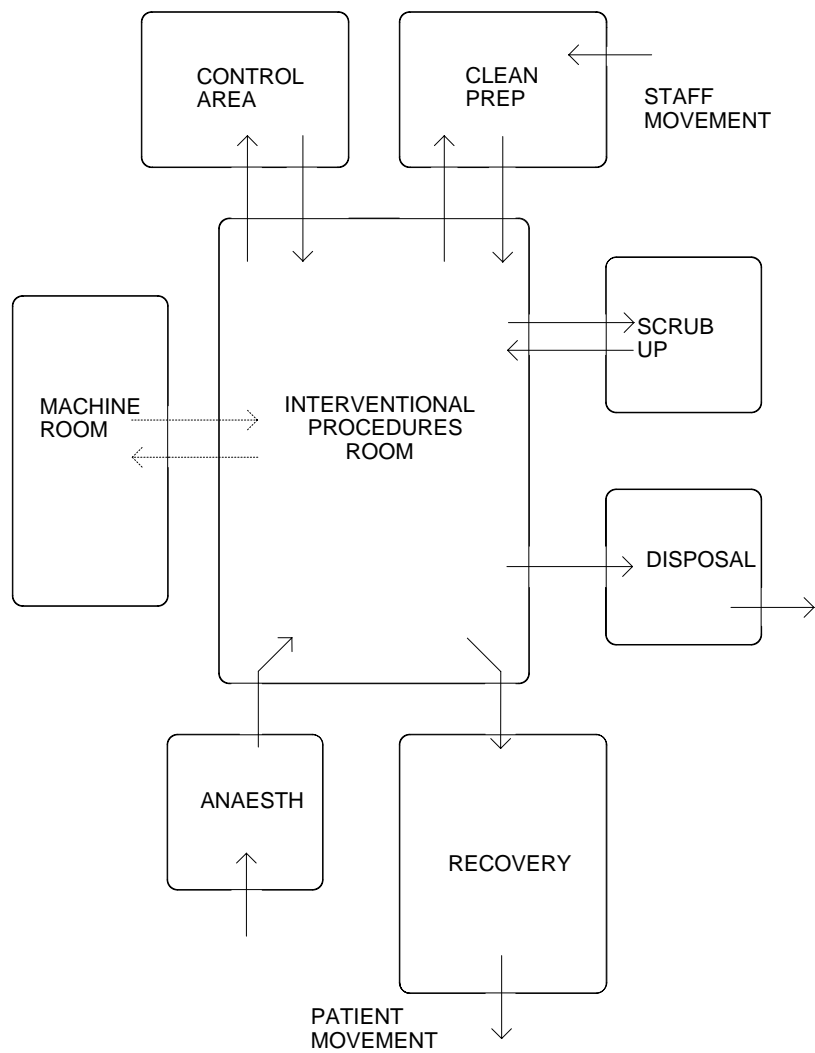

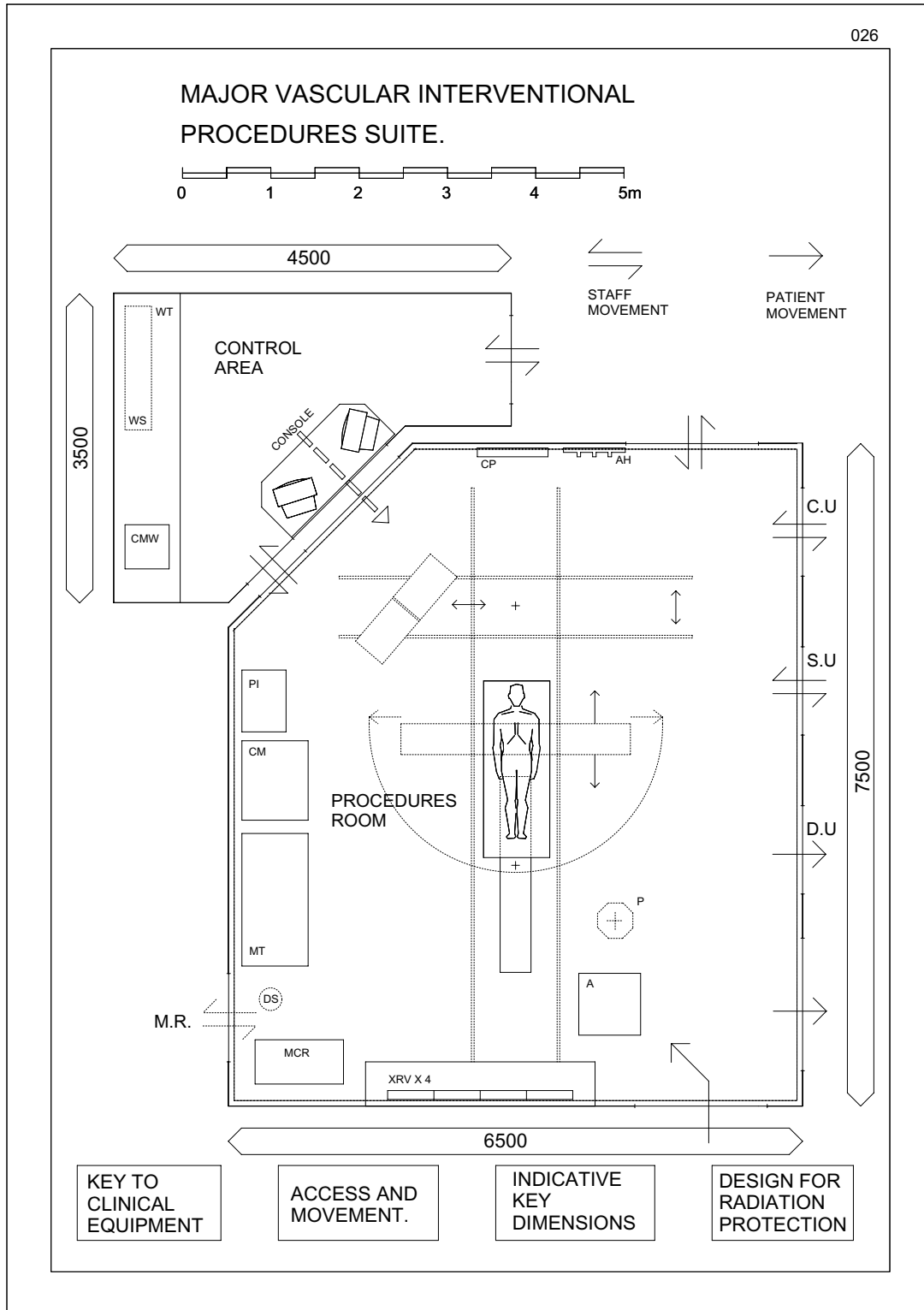

INTERVENTIONAL RADIOGRAPHY:
KEY TO CLINICAL EQUIPMENT /FITTINGS.

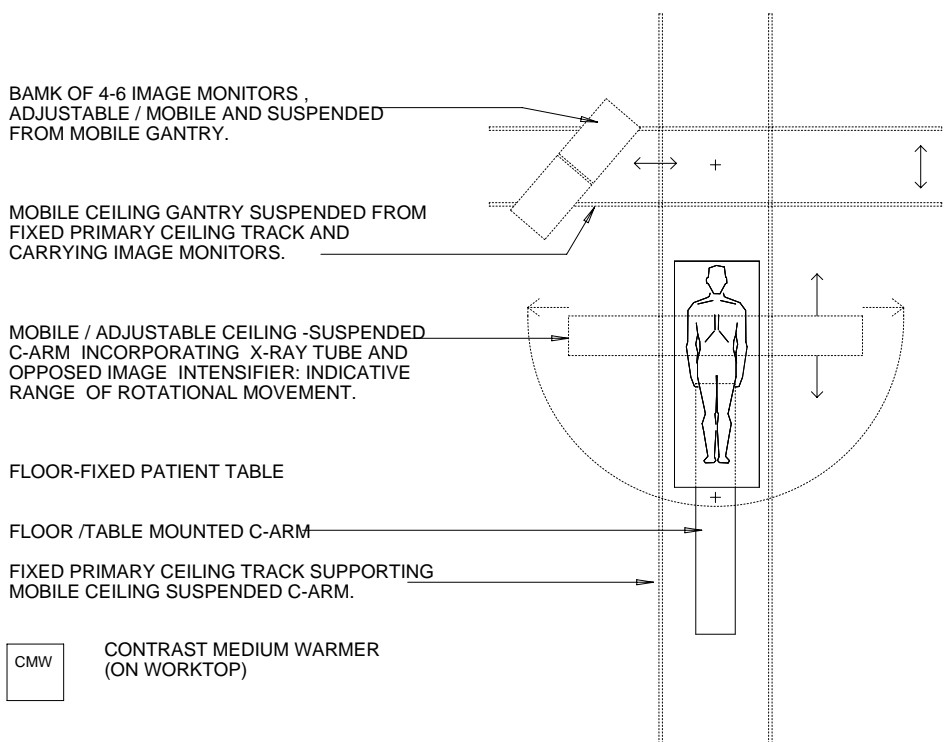
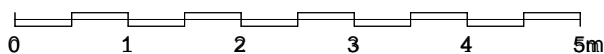

BANK OF 4-6 IMAGE MONITORS .
ADJUSTABLE / MOBILE AND SUSPENDED
FROM MOBILE GANTRY.

MOBILE CEILING GANTRY SUSPENDED FROM
FIXED PRIMARY CEILING TRACK AND
CARRYING IMAGE MONITORS.

MOBILE / ADJUSTABLE CEILING -SUSPENDED
C-ARM INCORPORATING X-RAY TUBE AND
OPPOSED IMAGE INTENSIFIER: INDICATIVE
RANGE OF ROTATIONAL MOVEMENT.

FLOOR-FIXED PATIENT TABLE

FLOOR /TABLE MOUNTED C-ARM

FIXED PRIMARY CEILING TRACK SUPPORTING
MOBILE CEILING SUSPENDED C-ARM.



CONTRAST MEDIUM WARMER
(ON WORKTOP)



CONTRAST MEDIUM POWER
INJECTOR.
(MOBILE & WITH REMOTE CONTROL)

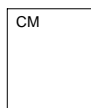

PATIENT LIFESIGNS
MONITOR (MOBILE)



IMAGE MONITOR /COMPUTER
(ON MOBILE DESKING)

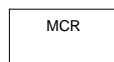

MOBILE RACKING FOR
CATHETERS ETC.



ANAESTHETIC
MACHINE



FIXED CEILING PENDANT
FOR MED. GAS /POWER

CP

ROOM VENT CONTROL PANEL

AH

LEAD APRON ETC HOOKS

XRV

WALL MTD XRAY VIEWERS



007

SINGLE GAMMA CAMERA ROOM:
INCORPORATING INJECTION AREA (1)

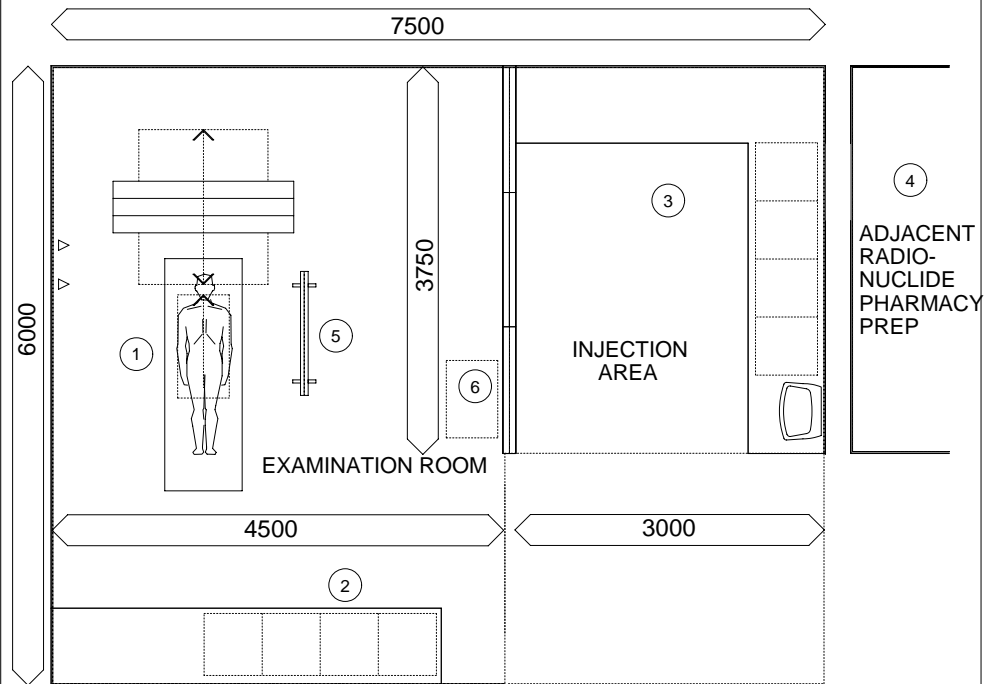
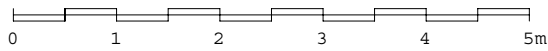

CONSTRUCTION FOR
RADIATION PROTECTION.

INDICATIVE KEY
DIMENSIONS.

- ① PATIENT IS A RADIOACTIVE SOURCE, FOLLOWING ADMINISTRATION OF RADIOPHARMACEUTICAL.
- ② SURFACES TO BE IMPERVIOUS AND ALLOW DISPOSAL OF RADIOACTIVE SPILLAGE.
- ③ INJECTION AREA TO BE DESIGNATED CONTROLLED ACCESS.
- ④ ADJACENT AREA FOR STORAGE, PREPARATION AND DISPOSAL OF RADIOPHARMACEUTICALS REQUIRES CONTROLLED VENTILATION AND SHIELDED CONSTRUCTION.
- ⑤ MOBILE LEAD -GLASS SCREEN, BETWEEN PATIENT AND STAFF POSITIONS.
- ⑥ FIXED LEAD-GLASS SCREEN

008

SINGLE GAMMA CAMERA ROOM:
INCORPORATING INJECTION AREA (2)

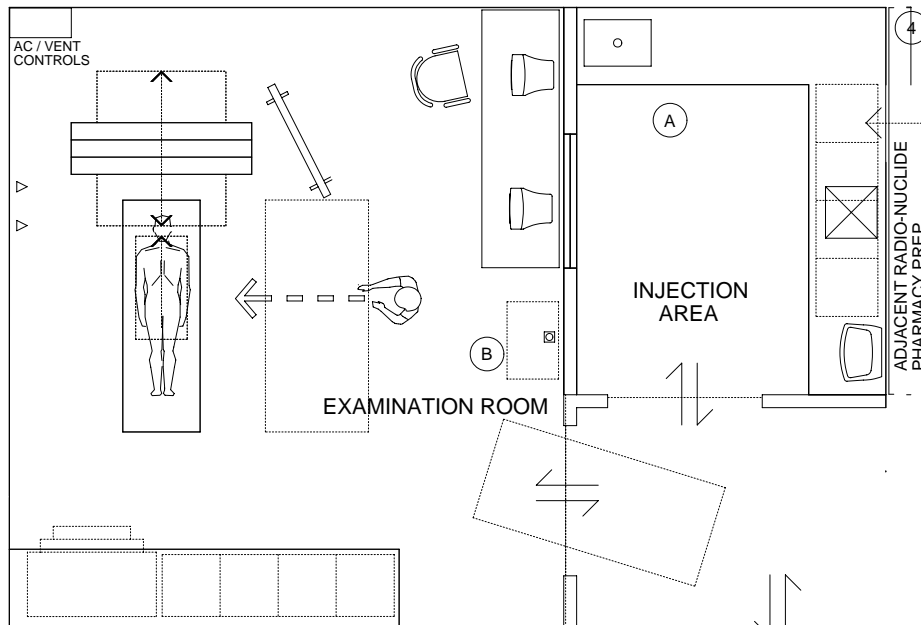
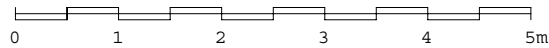

MOVEMENT AND
OBSERVATION.

DIAGNOSTIC IMAGING
EQUIPMENT : SEE KEY

← →
PATIENT MOVEMENT,
INCLUDING BED TROLEY
TRANSFER (DOUBLE DOORS)

← →
PATIENT MOVEMENT:
ALTERNATIVE ACCESS POINT.

←
TRANSFER HATCH FOR
RADIO PHARMACEUTICALS.

(A) (B) PATIENTS MAY BE OBSERVED
BOTH FROM INJECTION AREA AND
FROM WITHIN EXAMINATION ROOM

(RADIOLOGISTS MAY REMAIN
WITHIN THE EXAMINATION ROOM
DURING SCANNING PROCEDURE)

SINGLE GAMMA CAMERA ROOM:
INCORPORATING INJECTION AREA (3)

KEY TO EQUIPMENT LAYOUT

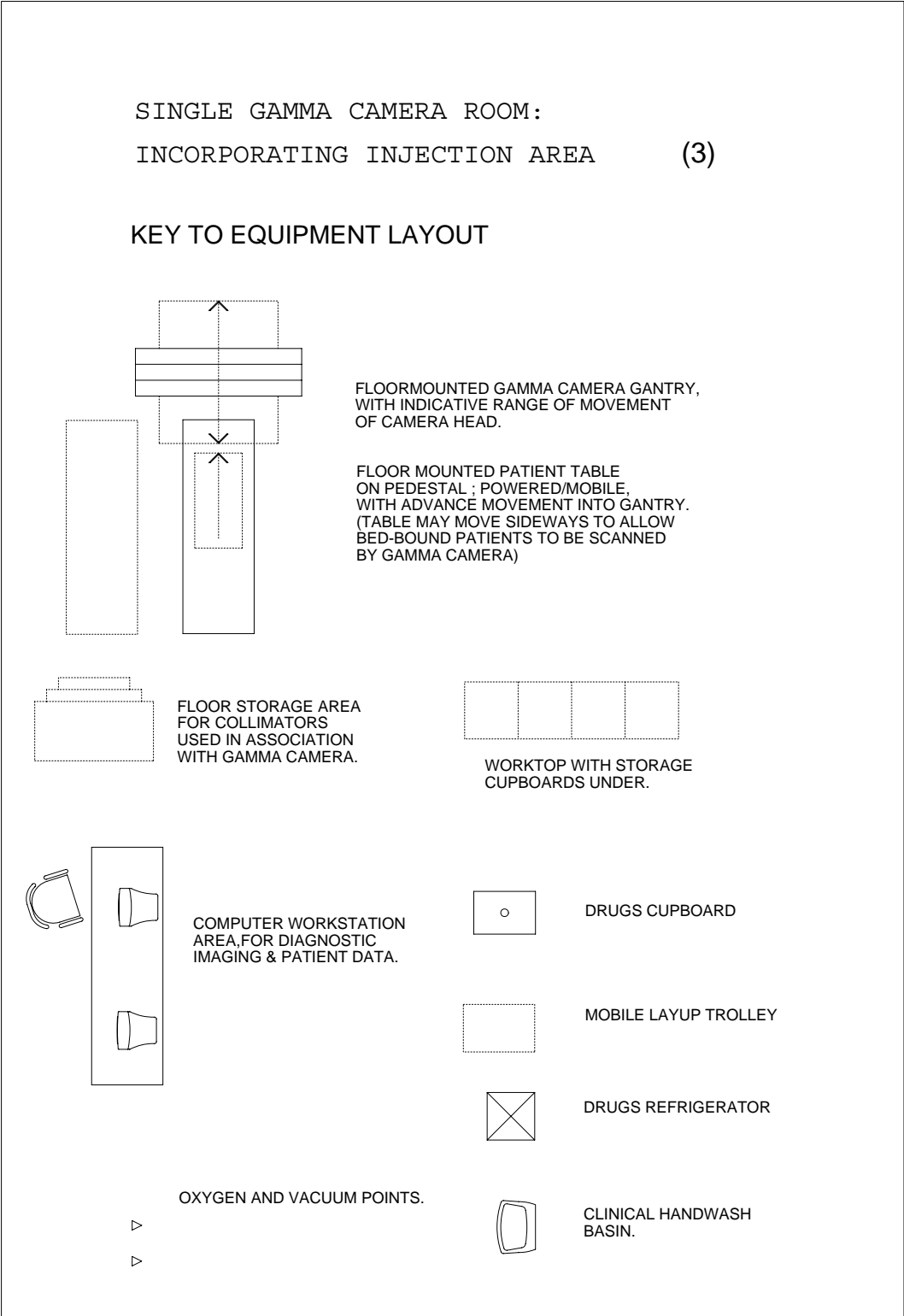

012

GAMMA CAMERA ROOM: WITH INJECTION AREA ELSEWHERE IN SUITE (1)

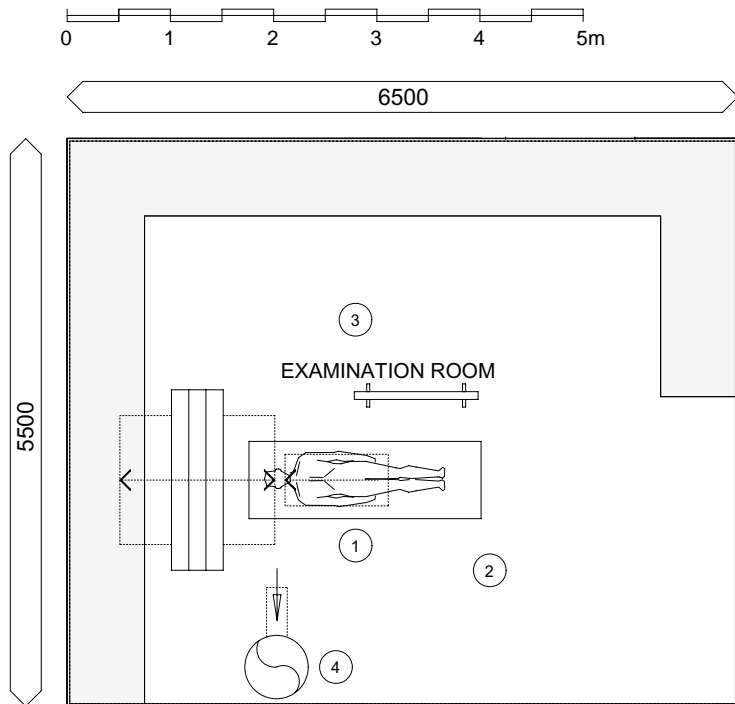

CONSTRUCTION FOR
RADIATION PROTECTION.

INDICATIVE KEY
DIMENSIONS.

- ① PATIENT IS A RADIOACTIVE SOURCE, FOLLOWING ADMINISTRATION OF RADIOPHARMACEUTICAL.
- ② SURFACES TO BE IMPERIOUS AND ALLOW DISPOSAL OF RADIOACTIVE SPILLAGE.
- ③ MOBILE LEAD-GLASS OR OTHER SCREEN, BETWEEN PATIENT AND STAFF POSITIONS.
- ④ LOCAL EXTRACT FOR EXHALED RADIOPHARMACEUTICAL AEROSOLS USED IN CERTAIN DIAGNOSTIC IMAGING PROCEDURES.

013A

GAMMA CAMERA ROOM: WITH INJECTION
 AREA ELSEWHERE IN SUITE (2)

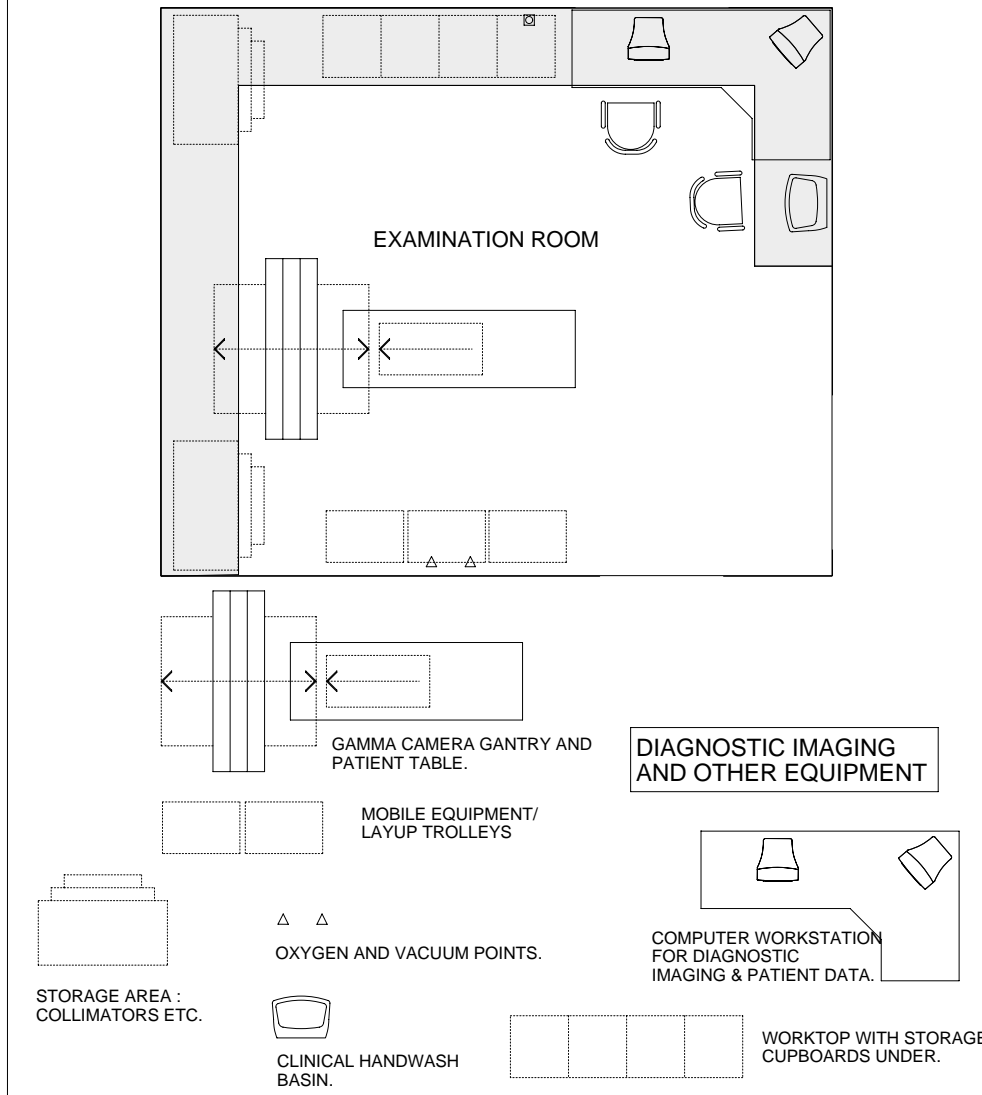
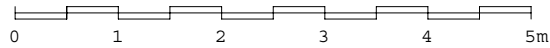

013C

GAMMA CAMERA ROOM: WITH INJECTION
 AREA ELSEWHERE IN SUITE (3)

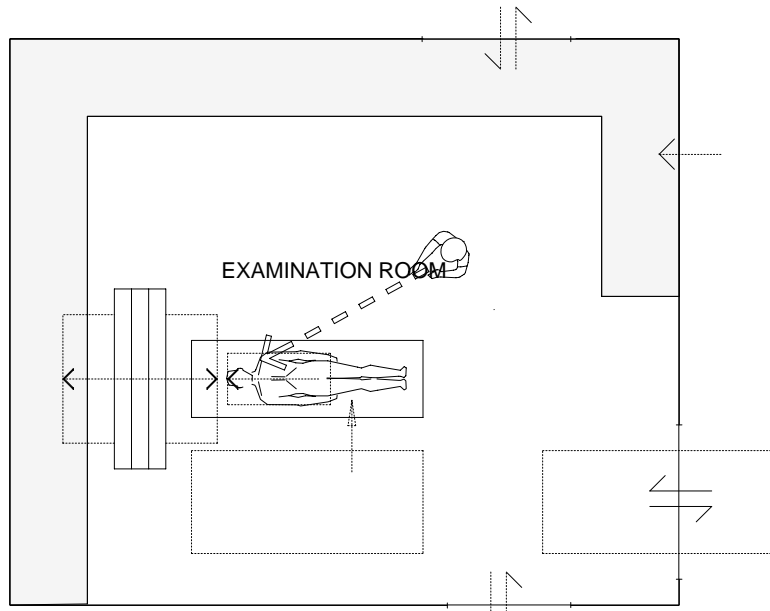
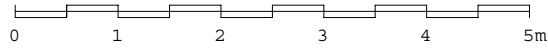

**MOVEMENT AND
 OBSERVATION.**



PATIENT / STAFF ACCESS FROM
 CORRIDOR , INCLUDING OCCASIONAL
 BED TROLLEY TRANSFER (DOUBLE DOORS).



STAFF USE LINK DOORWAY TO
 ADJOINING GAMMA CAMERA ROOMS,
 IF REQUIRED (ALTERNATIVE LOCATIONS)

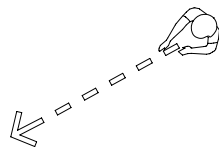

STAFF MAY REMAIN WITHIN ROOM
 DURING PROCEDURE, TO OBSERVE/
 REASURE PATIENTS. MOBILE LEAD-
 GLASS SCREENS WILL BE REQUIRED
 FOR LOCAL RADIATION PROTECTION.
 MINIMUM 2.5m SEPARATION NEEDED,
 BETWEEN PATIENTS POSITION, AND
 SEATED STAFF AT IMAGE MONITORS.

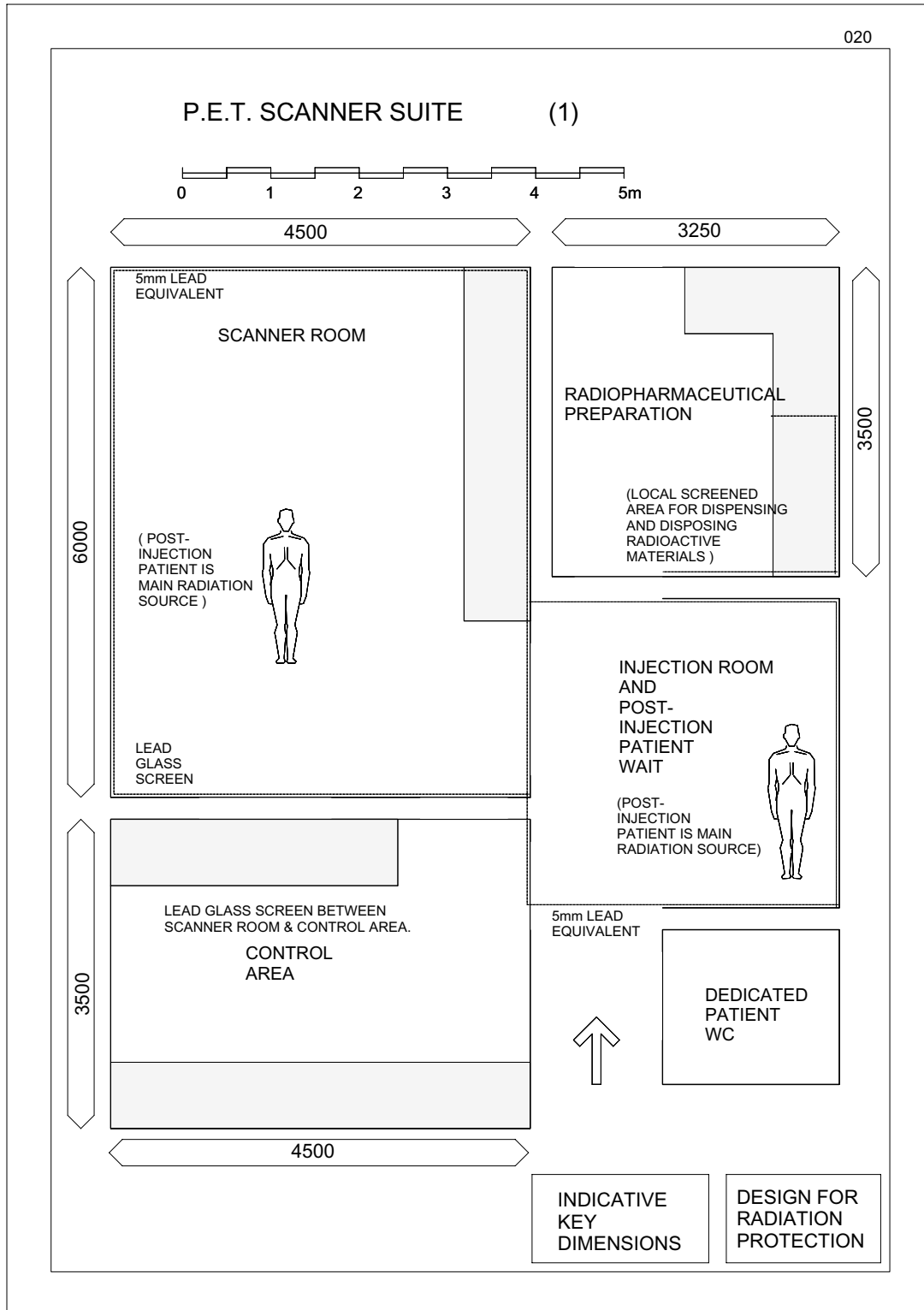

021

P.E.T. SCANNER SUITE (2)

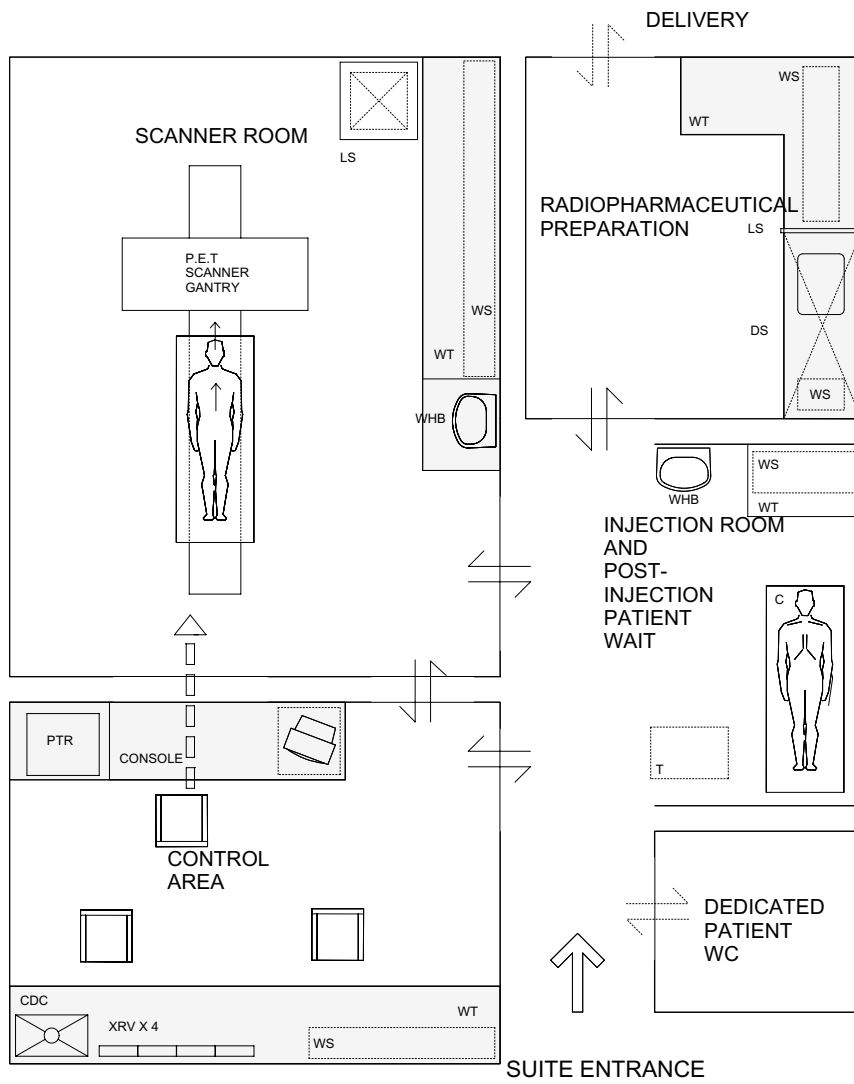
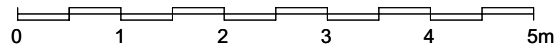

CLINICAL EQUIPMENT (SEE KEY)

ACCESS AND MOVEMENT.

P.E.T. SCANNER SUITE
KEY TO CLINICAL EQUIPMENT / FITTINGS

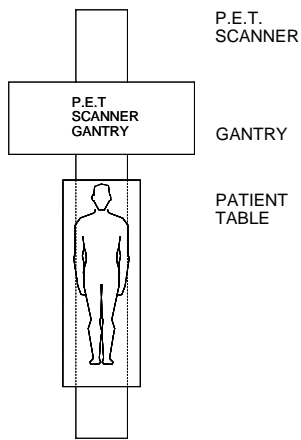
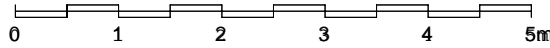

LS

LEAD SHIELDED STORAGE CUPBOARD FOR STORAGE OF LONG HALF-LIFE RADIOACTIVE MATERIALS USED TO CALIBRATE P.E.T SCANNER.

WT

WORKTOP WITH CUPBOARD UNITS UNDER. IMPERVIOUS & WITH COVERED UPSTANDS RAISED LEADING EDGE & SEALED JOINTS. (POSSIBLE SPILLAGE OF RADIOACTIVE MATERIALS)

WS

WALL-FIXED CUPBOARDS / SHELF

WHB

CLINICAL HANDWASH

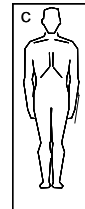
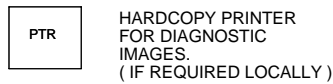

PATIENT COUCH :FOR QUIET WAITING POST-INJECTION AND PRIOR TO SCANNING PROCEDURE.



SCANNER CONTROLS & IMAGE RECONSTRUCTION MONITORS.



SMALL DRESSINGS ETC TROLLEY

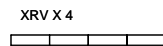

FOUR-PANEL WALL MOUNTED X-RAY FILM VIEWER.

030

SYMPTOMATIC MAMMOGRAPHY:
SINGLE IMAGING ROOM.

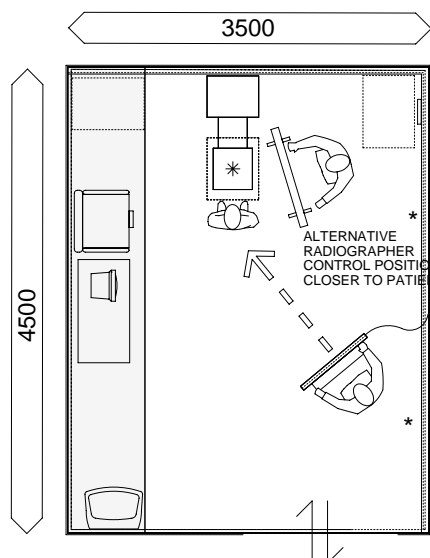
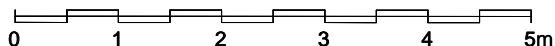

MAMMOGRAPHY X-RAY MACHINE: FREE-STANDING ON FLOOR & SEMI-MOBILE. PATIENT TYPICALLY STANDS OR SITS IN FRONT OF X-RAY MACHINE.

POWER / CONTROL CABINET SERVING X-RAY MACHINE (NOM 900mm HIGH)

SPACE ALLOWANCE FOR ADDITIONAL TECHNICAL EQUIPMENT IF REQUIRED

ADJUSTABLE HEIGHT SEAT FOR FRAIL OR WHEELCHAIR-BOUND PATIENTS.

SMALL WORKTOP WITH STORAGE UNITS UNDER & X-RAY VIEWER OVER.

CLINICAL HANDWASHING

MOBILE X-RAY PROTECTION SCREEN WITH REMOTE CONTROLS LINKED TO MAMMOGRAPHY X-RAY MACHINE.

WALL MOUNTED TRUNKING FOR POWER & CONTROL CABLING.

* EMERGENCY STOP CONTROL FOR X-RAY MACHINE.

CLINICAL EQUIPMENT AND FITTINGS

ACCESS MOVEMENT OBSERVATION

INDICATIVE KEY DIMENSIONS

CONSTRUCTION FOR RADIATION PROTECTION.

0.5mm LEAD EQUIVALENT AT 100 kV : TYPICALLY ACHIEVED BY 100mm DCM/BRICKWORK WALLS: CONSULT RPA.

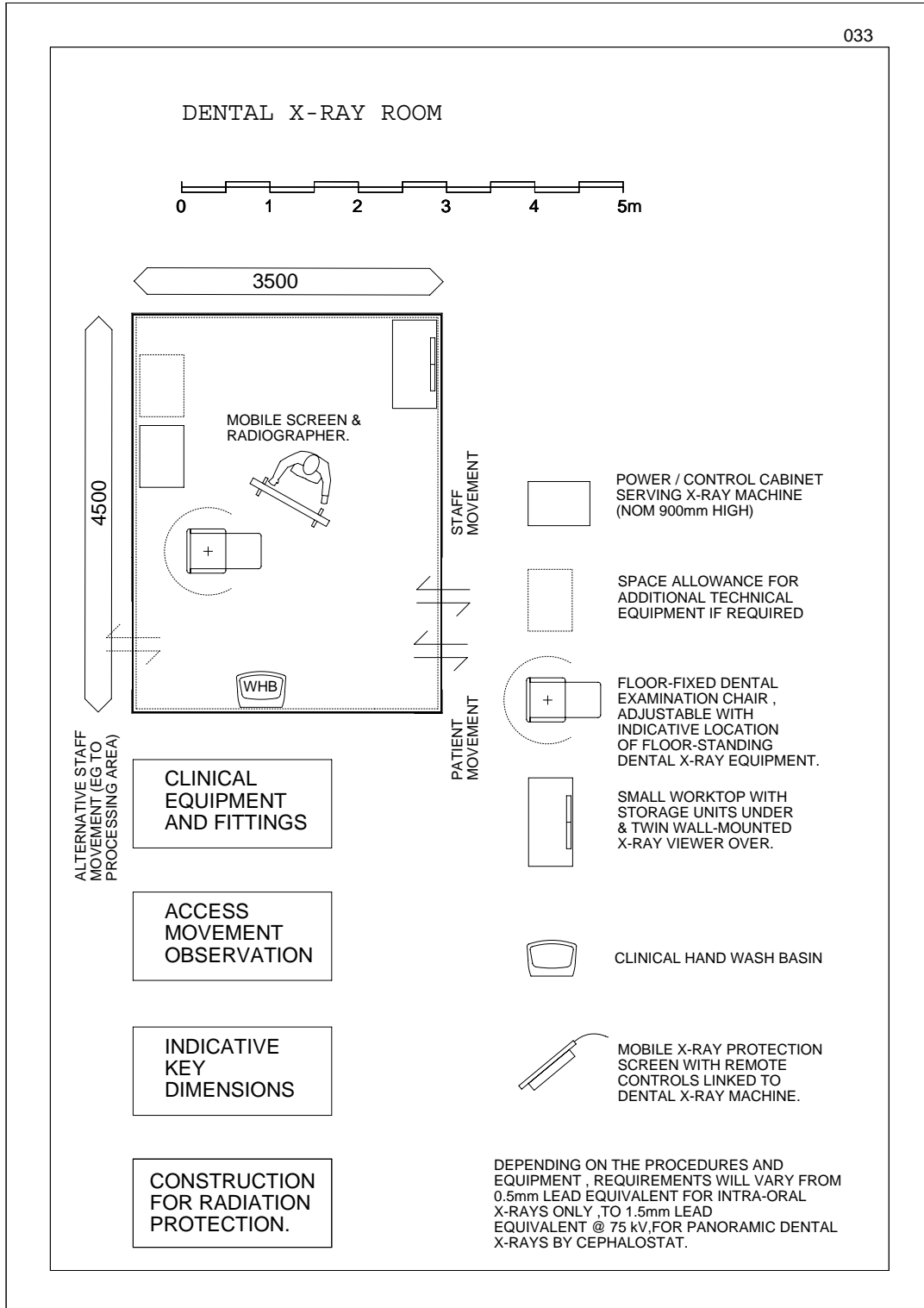

015

MULTI-CUBICLE ULTRASOUND SUITE

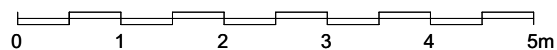

4750

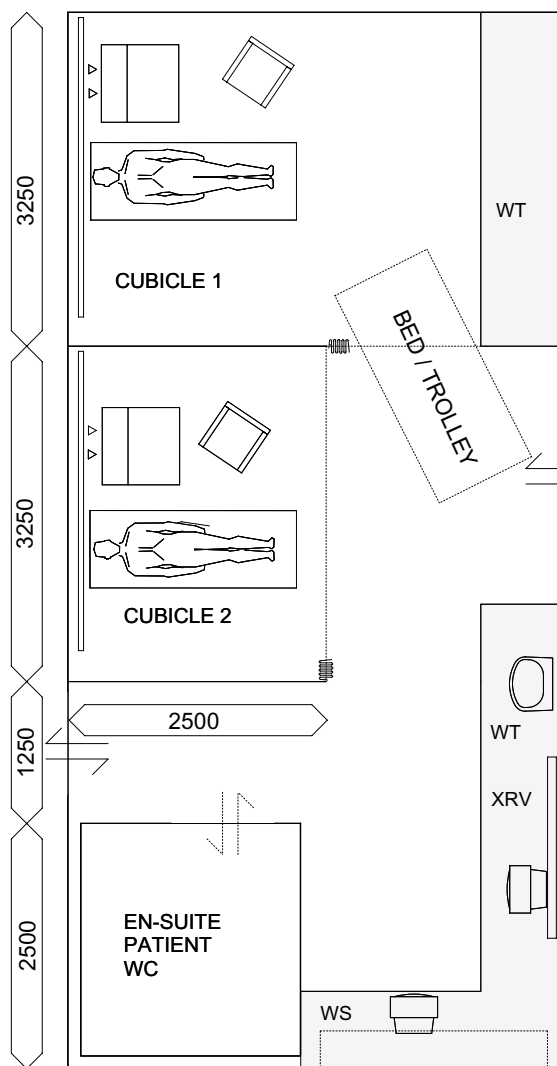

NOTE:
THE SHARED LAYOUT
AND CURTAINED CUBICLES
SHOWN ARE APPROPRIATE
ONLY FOR NON-INTIMATE
EXAMINATION AND FOR
APPROPRIATE PATIENT
GROUPS (EG PAEDIATRIC).
NUMBER OF CUBICLES
COMPRISING A SUITE
MAY VARY.

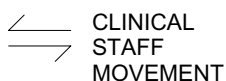
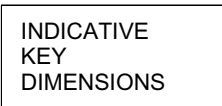
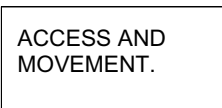
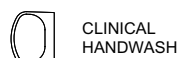
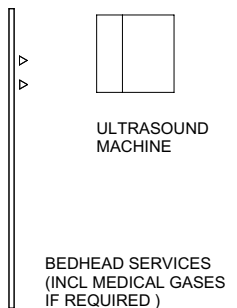

SINGLE ULTRASOUND ROOM: PLANNED/EQUIPPED FOR ROUTINE EXAMINATIONS AND MINOR INTERVENTIONAL PROCEDURES.

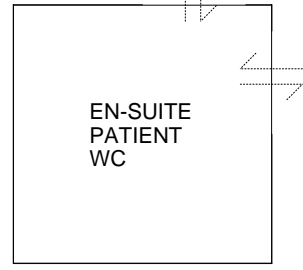
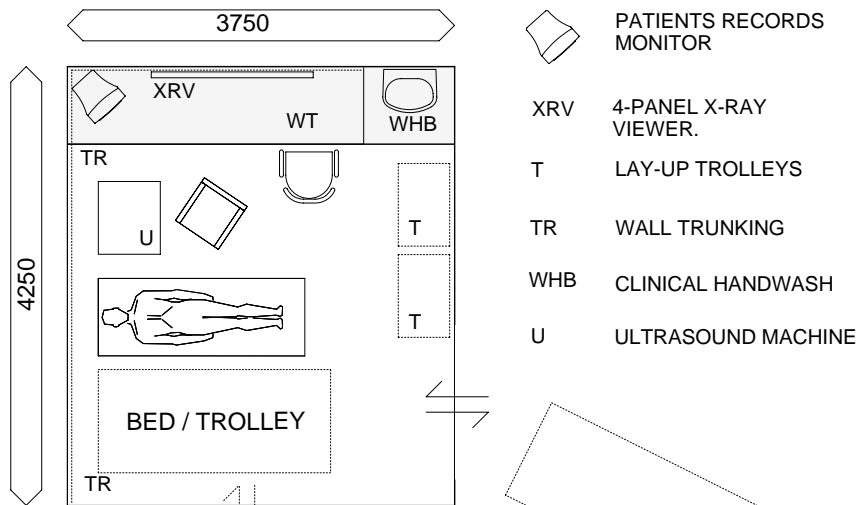
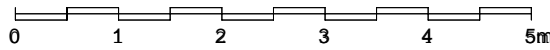

KEY TO CLINICAL EQUIPMENT

ACCESS AND MOVEMENT.

INDICATIVE KEY DIMENSIONS

017

INTERVENTIONAL ULTRASOUND

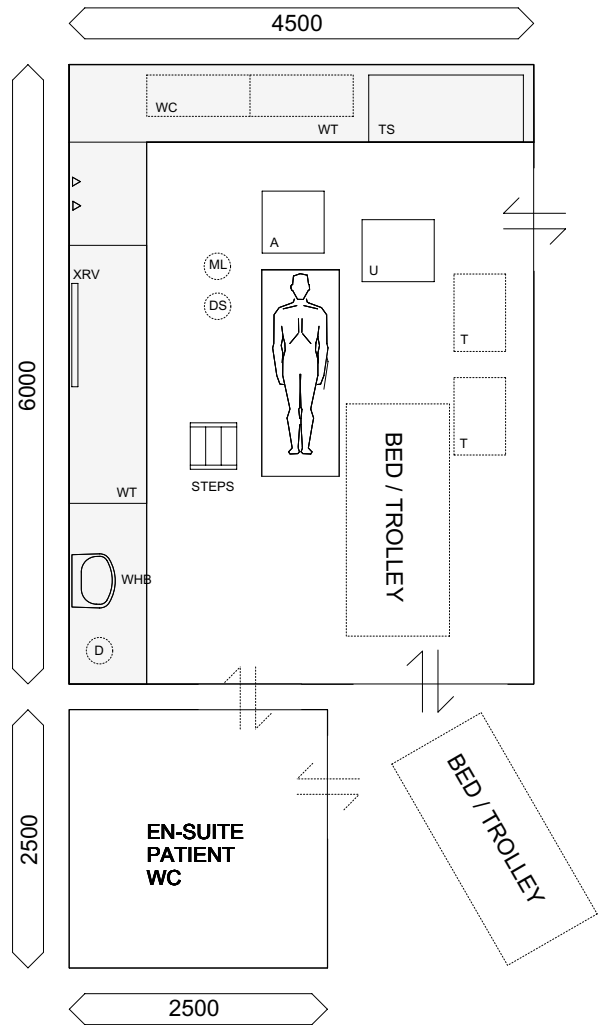
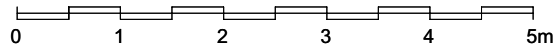

- TS TALL STORAGE UNIT FOR CATHETERS.
- WC WALL CUPBOARD
- WT WORKTOP WITH STORAGE UNDER.
- XRV 4-PANEL X-RAY VIEWER
- A ANAESTHETICS TROLLEY
- U ULTRASOUND MACHINE MOBILE
- T LAY UP TROLLEYS
- ML MOBILE EXAM LAMP
- DS DRIP STAND
- WHB CLINICAL HANDWASH

SEPARATE STAFF ACCESS (IF REQUIRED)

PATIENT MOVEMENTS, INCLUDING BED TROLLEY ACCESS TO ULTRASOUND ROOM.

**MR/CT SCANNER SUITE : INDICATIVE
DIAGRAM OF ROOM RELATIONSHIPS.**

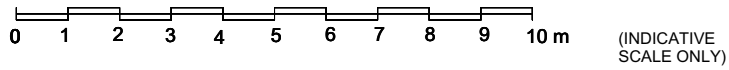

SUITE ENTRANCE

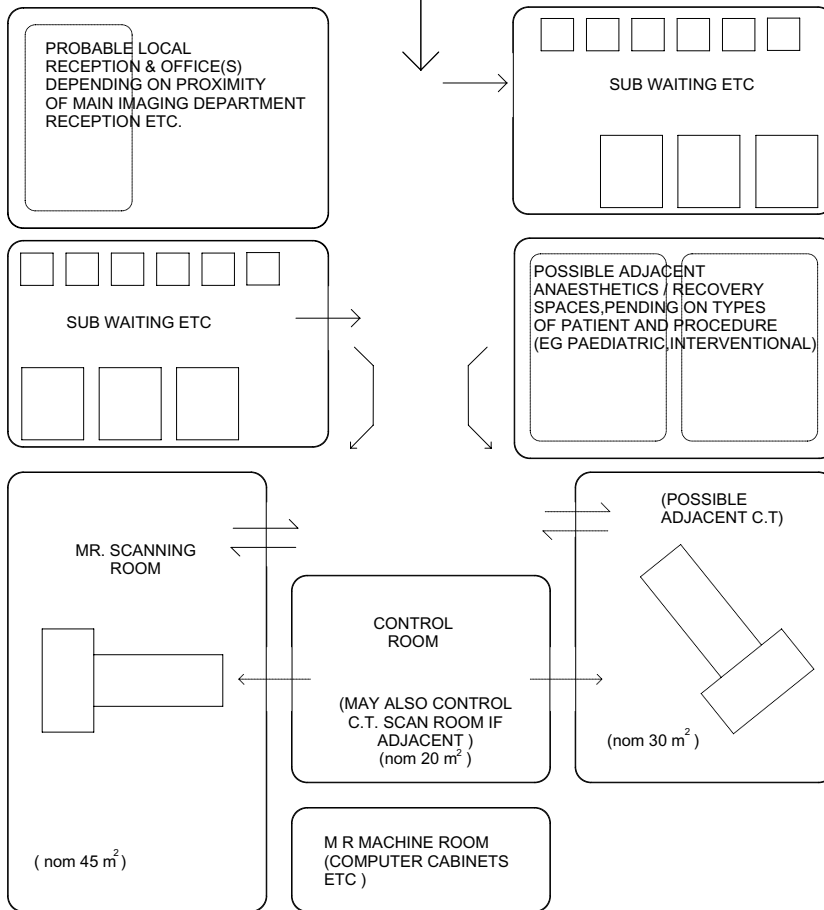

054

"BACK-TO-BACK" COMBINED
 CT/MR SCANNER SUITE
 INDICATIVE SECTIONS (1)

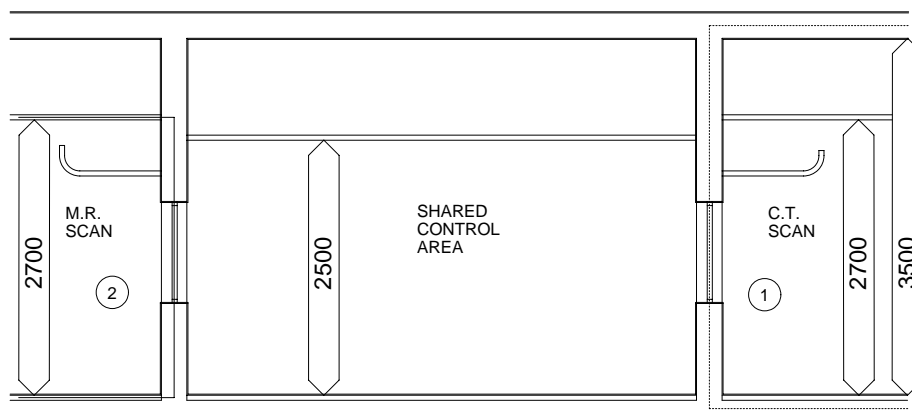
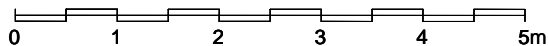
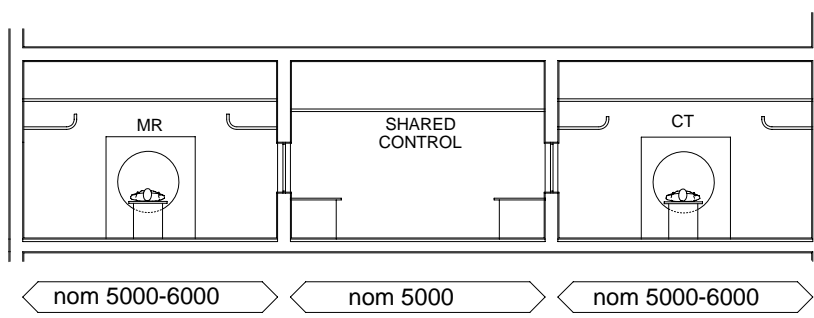
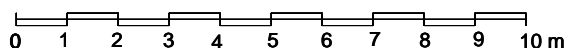

CONSTRUCTION FOR RADIATION PROTECTION.

①

C.T. SCANNER CREATES HIGHER LEVELS OF X-RAY RADIATION, COMPARED WITH GENERAL X-RAY MACHINES. BOUNDING CONSTRUCTION (INCLUDING DOORS, OBSERVATION SCREENS ETC) REQUIRES INDICATIVE 3.5mm LEAD EQUIVALENT SHIELDING.

INDICATIVE KEY DIMENSIONS.

②

M.R. SCANNER REQUIRES R.F. CAGE CONSTRUCTION ALL ROUND, TO PREVENT IMAGE QUALITY BECOMING DEGRADED BY ADJACENT FERROUS MATERIALS/MAGNETIC FIELDS ETC.

054A

"BACK-TO-BACK" COMBINED
CT/MR SCANNER SUITE
INDICATIVE SECTIONS (2)

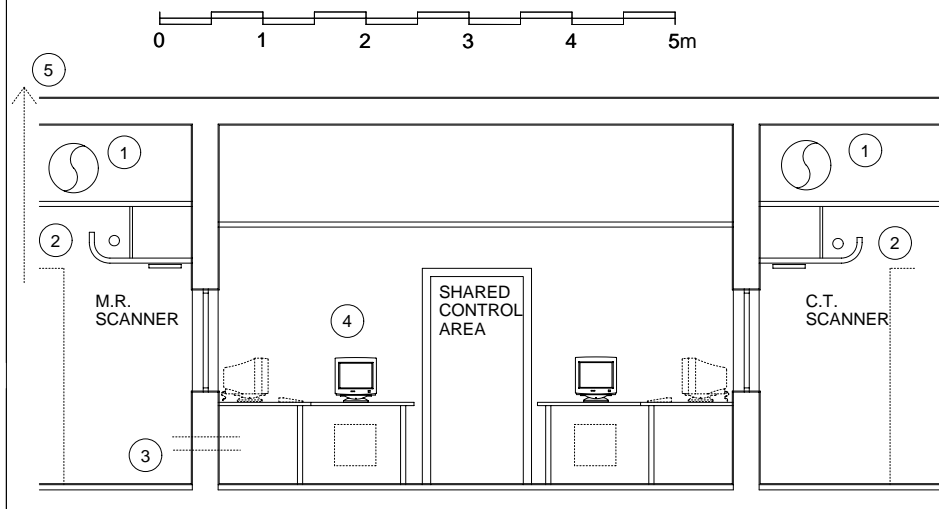

DIAGNOSTIC
IMAGING ETC
EQUIPMENT.

NOTE THAT MR AND CT SCANNERS ARE FLOOR -STANDING

MR SCANNER MAY IMPOSE SIGNIFICANT FLOOR LOADINGS ESPECIALLY
IF PASSIVE -SHIELDED. CONSULT MANUFACTURERS.

CONSTRUCTION ACCESS SPACE REQUIRED FOR INSTALLATION AND
REPLACEMENT. CONVENTIONAL DOUBLE DOORWAYS LIKELY TO BE
ADEQUATE FOR CT SCANNER , BUT LARGER PERMANENT CONSTRUCTION
ACCESS MAY NEED TO BE FORMED FOR MR MAGNET REPLACEMENT.
CONSULT MANUFACTURERS.

M&E SERVICES
DISTRIBUTION
ETC

1. MECHANICAL VENTILATION / COOLING REQUIRED TO ALL AREAS.
2. INDIRECT LIGHTING / PERIMETER DOWNLIGHTS IN SCANNER ROOMS.
(NOTE PATIENT IN SUPINE POSITION AND NO REQUIREMENT TO
ACCOMMODATE MAJOR CEILING MOUNTED EQUIPMENT)
3. PIPED /CABLE SERVICES PENETRATIONS OF R.F. CAGE CONSTRUCTION
IN MR ROOM , REQUIRE SPECIAL SLEEVING.
4. NOTE REQUIREMENT FOR INTERCOM COMMUNICATION TO PATIENT ,AND FOR
CCTV OBSERVATION OF 'FAR END' OF SCANNER :PARTICULARLY FOR
MR SCANNER ROOM.
5. VENTILATION PROVISION REQUIRED TO VENT CRYOGEN IN EVENT OF
QUENCH.

SEE ALSO MAIN TEXT.

055

C.T. SUITE (2) TWIN C.T. SCANNER ROOMS WITH SHARED CONTROL ETC AREAS.

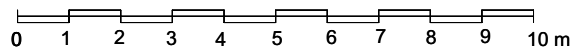

(INDICATIVE SCALE
ONLY)

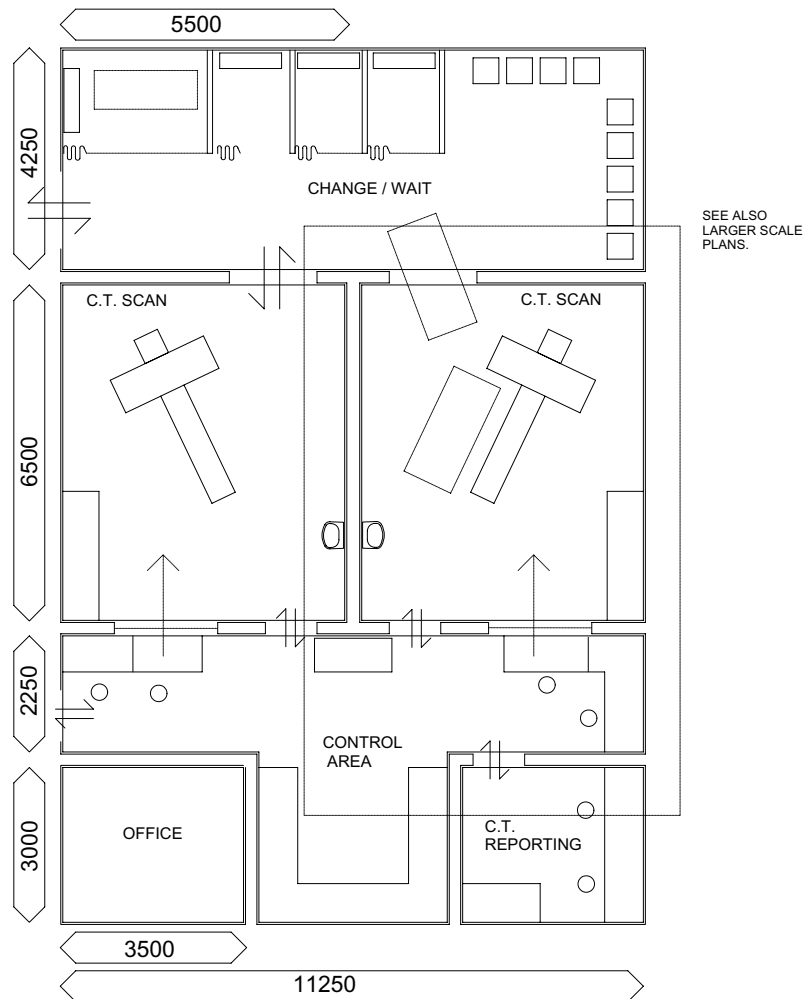

047A

M.R. SCANNER : INDICATIVE
EXTENT OF MAGNETIC FIELD.

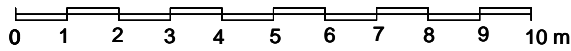

(INDICATIVE SCALE ONLY.)

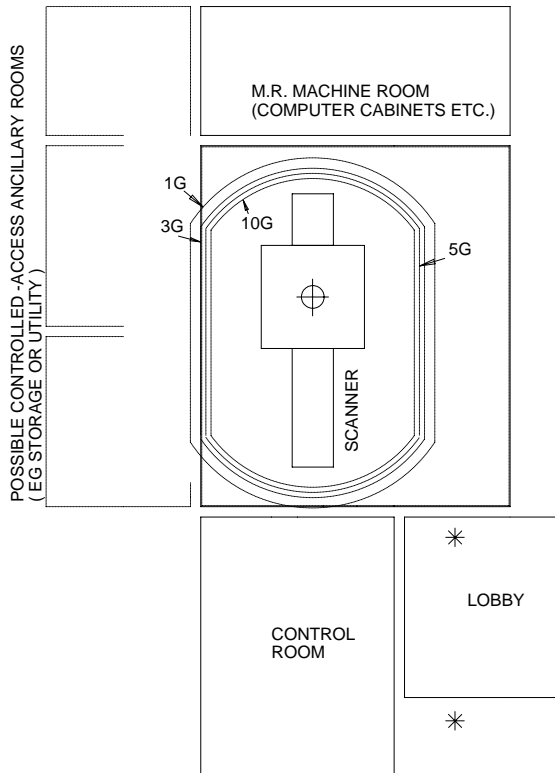

* INDICATES ACCESS CONTROL

STRAIGHT DASHED LINE AT ROOM PERIMETER INDICATES R/F CAGE CONSTRUCTION FOR CONTROL OF INTERFERENCE FROM ADJACENT ELECTRO-MAGNETIC FIELDS.

CURVED DASHED LINES INDICATE INTENSITY OF LOCAL MAGNETIC FIELD GENERATED BY M.R. SCANNER MAGNET, MEASURED IN GAUSS.

HEAVY DASHED LINE INDICATES 5-GAUSS CONTOUR , TO BE CONTAINED WITHIN SCANNER ROOM AND ADJACENT CONTROLLED AREA , IN COMPLIANCE WITH M.D.A. (MEDICAL DEVICES AGENCY) REQUIREMENTS.

LOWER -INTENSITY MAGNETIC FIELD (IE. BELOW 1 GAUSS CONTOUR INDICATED) MAY AFFECT ADJACENT DIAGNOSTIC IMAGING AND OTHER EQUIPMENT. SEE TEXT

GAUSS CONTOURS SHOWN ARE INDICATIVE ONLY, FOR MEDIUM - RANGE 1.5 TESLA M.R. SCANNER. CONSULT SUPPLIERS FOR SPECIFIC DETAILS.

MAGNETIC STRUCTURAL AND OTHER STEELWORK MAY INFLUENCE THE OVERALL EXTEND OF THE FRINGE FIELD.

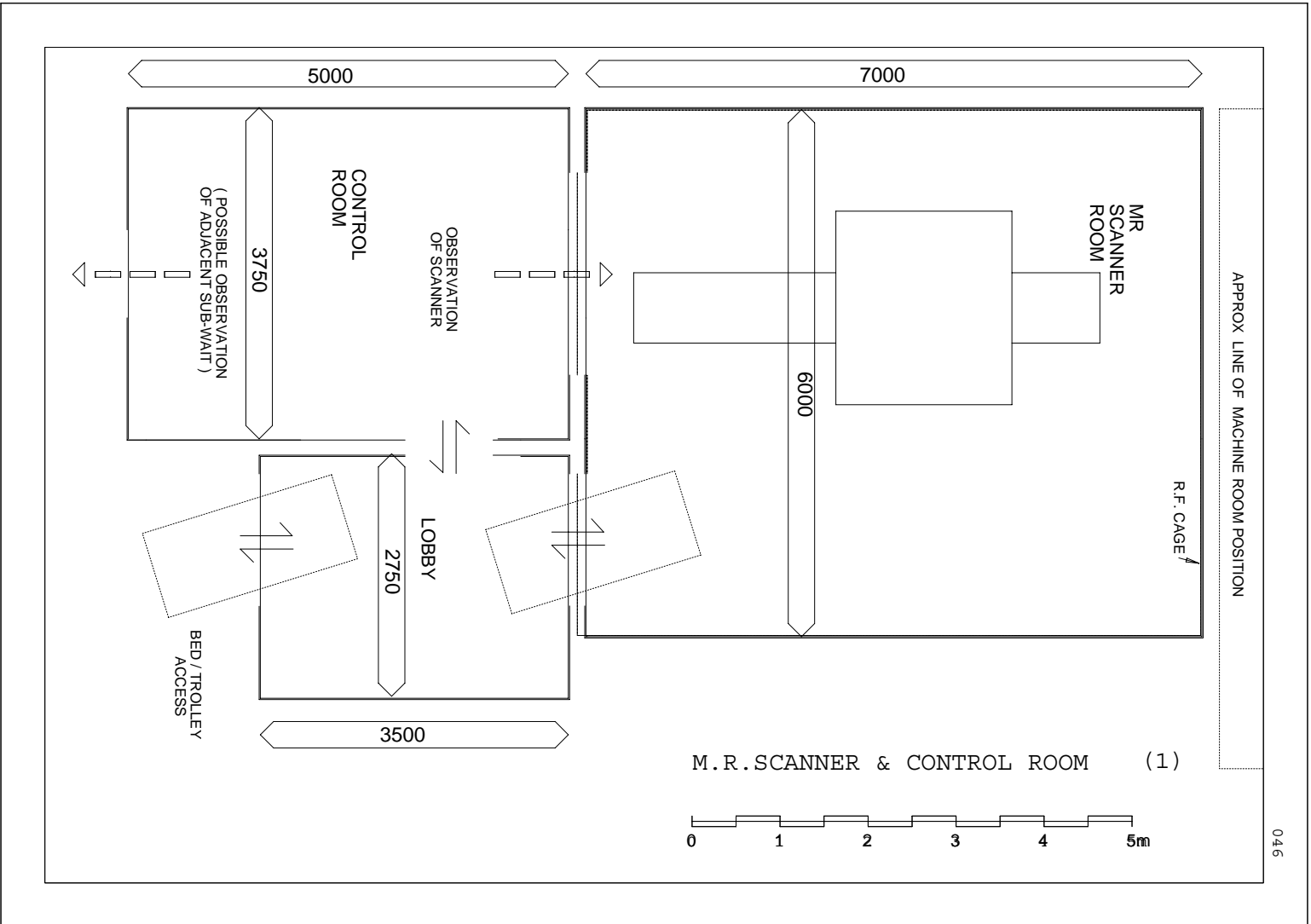

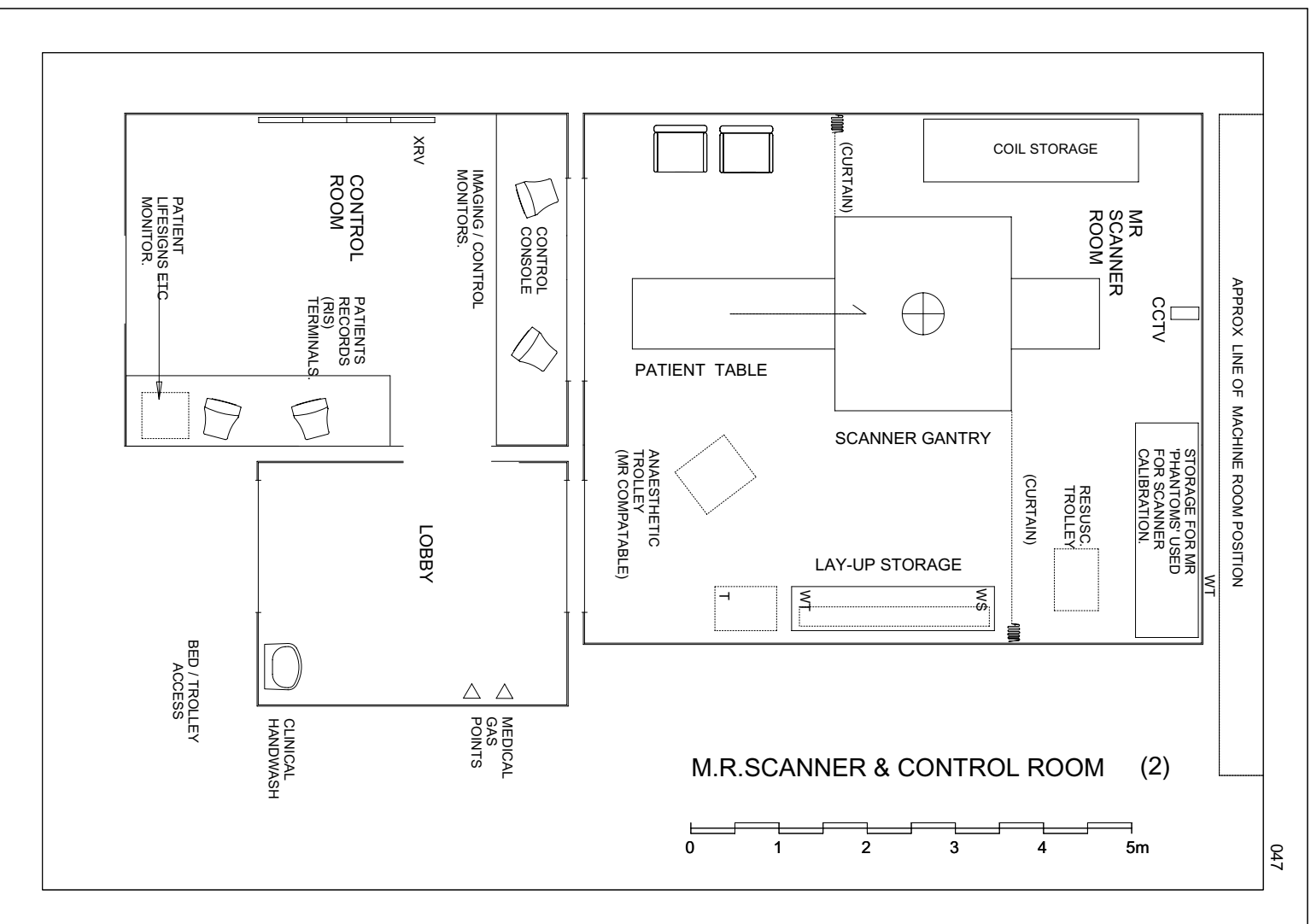

Appendix 2 Engineering requirements

SECTION 1 – GENERAL ENGINEERING REQUIREMENTS

Introduction

1.1 This appendix describes the engineering services contained within facilities for imaging services and how they integrate with the engineering systems serving the whole site. The guidance should acquaint the engineering members of the multi-disciplinary design team with the criteria and material specification needed to meet the functional requirements. Specific requirements should be formulated in discussion with both end-users and manufacturers of specialist equipment. Some issues particularly those related to radiation safety will require specific and detailed discussion with other professional consultants including the local RPA.

1.2 The majority of text below is concerned with the proper installation of the equipment in a suitable environment to enable high standards of reliability and overall imaging performance. However, designers should also consider the needs of the small percentage of patients who may be attending from areas of critical care and therefore attention should be paid to standards of infection control and overall cleanliness. The ventilation rates in some of the examination rooms, particularly those associated with CT and fluoroscopy, may need to be increased. It is likely that these examination rooms will also be used for minimally invasive interventional imaging procedures and the environment to care for critically ill patients may be commiserate with this clinical objective. Further guidance is contained in HTM 2025 on the design of ventilation systems for clinical spaces. The project design team should include infection control and anaesthetic policy officers, who will be able to provide further advice on the movement of critically ill patients to the diagnostic imaging department.

Model specifications and Technical Manuals

1.3 The National Health Service Model Engineering Specifications are sufficiently flexible to reflect local needs.

Value for money engineering

1.4 Engineering services are a significant proportion of the capital cost and remain a continuing charge on revenue budgets. The project design engineer should therefore ensure:

- value for money in initial provision, consistent with meeting functional requirements and maintaining clinical standards;
- designs are evolved to fit in with the Development Control Plan (DCP) and take into account details from current infrastructure surveys of capacity and capability;
- optimum benefit from the total financial resources these services are likely to absorb during their lifetime. Consideration should be given to generating “lifetime costings”, particularly if private finance is contemplated.

1.5 Where various design solutions are available, the consequential capital and lifetime running costs should be compared, using the discounting techniques described in the Capital Investment Manual.

1.6 In the current era PFI and PPP solutions will frequently require evaluation. These solutions must generate a financial advantage over more simple capital investment procedures. The finance gains are required to be sustainable over a reasonable working life for the building and the engineering systems within it. Accordingly, maintainability and the cost of maintenance are key factors in both business planning and the PFI/PPP evaluation process. The solutions must ensure that all organisational issues and policies are embodied into the design proposal.

1.7 The economic appraisal of various locations and design solutions should include the heat conversion and distribution losses to the point of use. Where buildings are remote from the development’s load centre, these losses can be significant.

1.8 The energy management should be part of the hospital building management system (BMS) and this should also include metering of all services where practical. If a hospital BMS is not available, the energy

management for this department should be stand-alone. It should also be suitable for subsequent integration with a future BMS. Further detailed guidance is contained in HTM 2005, 'Building management systems'.

1.9 In view of the increasing cost of energy, the project team should consider the economic viability of heat recovery and combined heat and power systems (CHP). The overall design should be energy efficient and further improvements may be obtained by using CHP processes. Further guidance on CHP can be found in 'A strategic guide to combined heat and power'. Designers should ensure that those services, which use energy, should do so efficiently and are metered where practicable.

Maximum demands

1.10 The estimated maximum demand and storage requirement, where appropriate, for each engineering service, will need to be assessed individually to take account of the size, shape, geographical location, operational policies and intensity of use of the department or modality.

1.11 Details of power consumption and load patterns of significant individual items of equipment must be sought from manufacturers and/or suppliers. Most commonly the finding of this information will take place as part of the equipment tendering process. Designers must ensure that the electrical loads are balanced across the infrastructure network and that there is sufficient capacity to meet current and potential future demands.

Activity data

1.12 Environmental and engineering technical data and equipment details are described in the Activity Data Sheets (forthcoming). They should be referred to for space temperatures, lighting levels, outlets for power, telephones, and equipment details. Significant gains in both management and patient service areas may be expected from the provision of a wide bandwidth LAN and associated computing equipment. This is especially true in the areas of radiotherapy and some parts of diagnosis and treatment planning.

Safety

1.13 The Health and Safety at Work etc Act 1974, as partly amended by the Consumer Protection Act 1987, together with the Management of Health and Safety Regulations (1999), the Construction (Design and Management) (amendment) Regulations 2000, the Workplace (Health, Safety and Welfare) Regulations (1999) and the Provision and Use of Work Equipment Regulations (1992), imposes statutory duties on employers and designers to minimise – so far as reasonably practicable – any risks arising from the use, cleaning or maintenance of engineering systems. One of

the requirements of this legislation is to ensure, so far as is reasonably practicable, that design and construction is such that articles and equipment will be safe and without risks to health at all times when it is being used, cleaned or maintained by a person at work. The 1999 Ionising Radiations the 2000 IRME Regulations and the associated Codes of Practice place onerous requirements upon engineering aspects of design and operation of diagnostic X-ray imaging modalities. Over and above this, there are additional requirements from the 1993/2000 Radioactive Substances Act in respect of storage, use and disposal of radioactive materials. The RPA and Custodian of Radioactive Substances must be consulted in this regard.

Noise and speech privacy

1.14 Excessive noise and vibration from engineering services, whether generated internally or externally and transmitted to individual areas, or noise from other sources, for example, speech, which can be transmitted by the ventilation system, can adversely affect the operational efficiency of the department and cause discomfort to patients and staff. The limits and means of control advocated in HTM 2045, 'Acoustic design', should provide an acceptable acoustic environment.

1.15 In addition to designing for control of noise levels, there may also be a need to ensure speech privacy, so that confidential conversations are unintelligible in adjoining rooms or spaces. This will be important in consulting/examination and counselling rooms, particularly where these are located adjacent to waiting areas. The use of induction loop facilities for those with hearing impairment should be considered, and the privacy in conversations conveyed by such means should equal that granted to able-bodied persons.

Environmental requirements

1.16 Detailed environmental requirements for specialist equipment should be obtained from original equipment manufacturers. The comfort of patients and staff are an essential consideration in respect of temperature stability and the effects of waste heat derived from high-powered diagnostic imaging systems. Humidity and temperature control will frequently be a key feature of successful design. Centralised chilling and air conditioning units should be considered in preference to local stand-alone units.

Space for imaging generators, transformers, computers, plant/services

1.17 Where appropriate, space for electrical equipment, such as generators, gradient cabinets, plant and services should provide easy and safe means of access, protected as far as possible from unauthorised entry. Authorised entry will be needed for inspection and

maintenance. Sufficient access panels should be provided for this purpose. In the provision of panels and access points, consideration must be given to ensuring the integrity of fire barriers and that the control of smoke is appropriately maintained.

1.18 Consideration must be given to the need for the eventual removal and replacement of plant, transformers, generators and other related items of diagnostic imaging equipment.

1.19 Recommended spatial requirements for mechanical, electrical and public health engineering services are contained in HTM 2023 – ‘Accommodation for plant and services’. Reference is also made in HTM 2023 to the Construction (Design and Management) Regulations. The information in this HTM is specifically intended for use during the initial planning stages when precise dimension details of plant are not available.

1.20 The distribution of mechanical and electrical services to final points of use should be concealed in walls, floors and above suspended ceilings. Heat emitters should be contained within a 200mm wide perimeter zone under window sills, where appropriate, and critical dimensions should be taken from the boundary of this zone.

1.21 The 200 mm zone includes the floor area occupied by minor vertical engineering ducts and is included in the building circulation allowance.

1.22 Services contained in the space above the false ceiling, with the exception of drainage, should be confined to those required for the department.

1.23 All mechanical and electrical services entering rooms potentially containing radiation must be routed through specially designed access ports so that shielding is compromised as little as possible. It may also be necessary to design-in changes in direction of ductwork, and cable containment systems to provide protection against radiation leakage in some examination rooms, for example in the imaging rooms containing fluoroscopy and CT equipment. The RPA and original equipment manufacturer will need to be consulted with respect to the above.

1.24 In some installations, existing services may pass into the room at low level, from an adjacent plant or technical room and rise into their final position close to the actual imaging equipment. An example of this configuration would be centrally located fluoroscopy equipment mounted on a combination of a c-arm and L-arm as described in the main text.

1.25 The precise installation arrangements will be modality and project specific and should be determined with the installation specialist of the original equipment manufacturer. In MRI installation there are specific

requirements, which are detailed in [Section 8](#) of this appendix.

Access to control and isolation devices

1.26 Devices for control and safe isolation of engineering services should be:

- located in circulation rather than working areas;
- protected against unauthorised operation;
- clearly visible and accessible, where intended for operation by the department staff.

1.27 In a diagnostic area the access arrangements must not compromise the radiological protection provided for these rooms. Consideration should be given to the comfort as well as the safety of patients and others.

Engineering commissioning

1.28 The engineering services should be commissioned in accordance with the validation and verification methods identified in the latest HTMs. Engineering services for which a specific HTM is not currently available should be commissioned in accordance with ‘Engineering commissioning’ published by the Institute of Healthcare Engineering and Estate Management. Flow measurement and proportional balancing of air and water systems require adequate test facilities to be incorporated at the design stage. Guidance is also contained in commissioning codes published by the Chartered Institute of Building Services Engineers.

1.29 The services for some diagnostic imaging equipment may need to be commissioned before the final completion of the engineering contract programme, to allow the imaging equipment commissioning to be completed prior to the first patient. Parts of this commissioning are concerned with radiation safety and the approval of the RPA must be obtained for the imaging processes and schedules proposed.

Fire precautions

1.30 It is essential that project teams familiarise themselves with the guidance contained in the Firecode suite of documents, which contain the Department of Health policy and technical guidance on fire precautions in hospitals and other NHS premises. In particular, the need for structural fire precautions and means of escape from the whole accommodation must be taken into account at the earliest possible planning stage. The key document for these aspects in hospitals is ‘Firecode: Fire precautions in new hospitals’, Health Technical Memorandum (HTM) 81.

1.31 In addition, basic policy, principles and key management guidance are contained in ‘Firecode: Policy and principles’. Other Firecode documents

include the Health Technical Memorandum '80' series (which give technical guidance on various building, engineering and equipment Issues), the Fire Practice Notes series (dealing with various specialist aspects of fire precautions) and Nucleus guidance.

1.32 It is important to establish during the design stage those aspects of fire safety strategy that affect the design configuration and structure of a project. At the appropriate stages of the design process, the architect and engineer should discuss and verify their proposals with the local fire authority. They should also ensure that the project team and all other planning staff are fully acquainted with the fire safety strategy for the design in terms of operation (for example, staff responsibilities), equipment provision, and buildings and engineering layouts. HTMs 57, 58, 59 and 60 give detailed information on the selection of fire resisting components.

1.33 Existing fire policies, drawings and inspection inventories should also be considered as part of the integration of design for fire safety. The principles of fire safety apply equally to new projects and to alterations and upgrading of existing buildings.

Mechanical services

Heating

1.34 Spaces heated by low-pressure hot water systems should use radiators of the low surface temperature type. Surface temperatures should not exceed 43°C. Exposed hot water pipework, accessible to touch, should be insulated. Further guidance is contained in NHS Estates' Health Guidance Note – "Safe hot water and surface temperatures".

1.35 Radiators should normally be located under windows or against exposed walls with sufficient clear space between the top of the radiator and the window sill to prevent curtains reducing the output. There should be adequate space underneath to allow cleaning machinery to be used. Where a radiator is located on an external wall, back insulation should be provided to reduce the rate of heat transmission through the building fabric. Special care is needed when radiators are installed in rooms where unsealed or liquid radioactive sources are used. Protection of such fitting against radioactive contamination will be essential.

1.36 It is recommended that radiators be fitted with thermostatic radiator valves. These should be of robust construction and selected to match the temperature and pressure characteristics of the heating system. The thermostatic head, incorporating a tamper proof facility for pre-setting the maximum room temperature, should be controlled via a sensor located integrally or remotely as appropriate. To provide frost protection at its minimum setting, the valve should not remain closed

below a fixed temperature. In calculating heating requirements care must be taken to include heat yield from high-powered equipment.

1.37 Radiators may also be used to offset building fabric heat loss in mechanically ventilated spaces.

1.38 Flow temperatures to heating appliances should be controlled by the BMS, in accordance with space requirements and external temperatures. The system should be zoned to suit the building.

Ventilation (general)

1.39 Wherever possible, individual spaces should be naturally ventilated. Deep planned spaces may need mechanical ventilation. Planning should, therefore, seek to minimise the need for mechanical ventilation by ensuring that, wherever practicable, core areas are reserved for:

- a. spaces that require mechanical ventilation for clinical or functional reasons, irrespective of whether their location is internal or peripheral, for example, sanitary facilities, dirty utility and beverage preparation areas;
- b. spaces that have only transient occupation and, therefore, require little or no mechanical ventilation, for example, circulation and some storage areas.

1.40 The majority of the areas within the facility will require mechanical ventilation, due to equipment heat gains, patient/staff numbers and clinical reasons.

1.41 Air movement induced by mechanical ventilation should be from clean to dirty areas. The design should allow for adequate flow of air into any space having only mechanical extract ventilation, via transfer grilles in doors or walls. Such arrangements, however, should avoid the introduction of un-tempered air and should not prejudice the requirements of firecode, privacy, or protection from ionising and non-ionising radiation.

1.42 Mechanical ventilation should ensure that both supply and extract systems are in balance, and take account of infiltration as appropriate.

1.43 Fresh air should be introduced via a low velocity system and should be tempered and filtered before being distributed via high level outlets. Diffusers and grilles should be located to achieve uniform air distribution within the space without causing discomfort to patients.

1.44 The supply plant for ancillary accommodation should be separate from plant serving the imaging services department.

1.45 A separate extract system will be required for "dirty" areas, for example, toilet facilities and dirty utilities. It should operate continuously throughout the

day and night. A dual motor fan unit with an automatic changeover facility should be provided.

1.46 External discharge arrangements for extract systems should be protected against back pressure from adverse wind effects and should be located to avoid reintroduction of exhausted air into this or adjacent buildings through air intakes and windows.

1.47 Further detailed guidance is contained in HTM 2025 – ‘Ventilation in healthcare premises: Design considerations’.

Ventilation controls

1.48 Supply and extract ventilation systems should include indicator lamps to confirm the operational status of each system. Where a system is provided for a particular space, the indicator should be in, or immediately adjacent to, that space and local controls should be provided as appropriate. In the case of a more general system of ventilation, for example WCs, the indicator should preferably be located at the reception desk or other suitable location. Where manual controls are available for staff use, they should be provided with labels clearly defining their function. Where manual overrides of time switches controlling the running periods of ventilation plants are provided, they should be grouped with the temperature control overrides.

Ventilation (substances hazardous to health)

1.49 Local exhaust ventilation will be required where exposure by inhalation of substances hazardous to health cannot be controlled by other means. The Health and Safety Executive in their publication EH40, ‘Occupational Exposure Limits’, updated annually, sets limits which form part of the Control of Substances Hazardous to Health Regulations 1999 (COSHH). In the provision of diagnostic imaging services this will primarily relate to the use of chemicals in film processing and radioactive substances in radionuclide imaging.

Piped medical gases

1.50 Information regarding piped medical gases is given in HTM 2022. The location of outlets is indicated on the Activity Data Sheets (forthcoming).

1.51 In any special procedures room where nitrous oxide is used, provision should be made for active scavenging of waste anaesthetic gases in accordance with the recommendations of BS EN 740).

Hot and cold water services

1.52 Guidance on the design and installation of hot and cold water supply and distribution systems is contained

in HTM 2027 – ‘Hot and cold water supply, storage and mains services’.

1.53 All cold water pipework, valves and fittings should be economically insulated and vapour sealed to protect against frost, surface condensation and heat gain.

1.54 The domestic hot water supply should be taken from the general hospital calorifier installation at a minimum outflow temperature of $60^{\circ}\text{C} \pm 2.5^{\circ}\text{C}$ and distributed to all outlets such that the return temperature at the calorifier is not less than 50°C . See Health Guidance Note – ‘“Safe” hot water and surface temperatures’.

1.55 The requirements for the control of legionellae bacteria in hot and cold water systems are set out in HTM 2040 – ‘The control of legionellae in health care premises – a code of practice’.

1.56 Architects and engineers should collaborate to ensure that requirements for any landscape designs/water features are considered.

1.57 Special considerations exist in MRI and are outlined in Section 8 of this appendix.

Lighting – general circulation and waiting areas only

1.58 Colour finishes and lighting throughout the department should be co-ordinated to create a calm and welcoming atmosphere. Practical methods are contained in the CIBSE Lighting Guide LG2 – ‘Hospitals and Health Care Buildings’. Consideration must always be given to the needs of the wide variety of patient, staff and carers who are visually impaired, or suffer from illnesses which may be triggered by flickering lights.

1.59 Architects and engineers should collaborate to ensure that decorative finishes are compatible with the colour rendering properties of the lamp and that the spectral distribution of the light sources is not adversely affected.

1.60 Architects should also be aware that some patients will arrive in the department on trolleys and beds and may wait in specifically designated waiting areas. The lighting should be designed to ensure that these patients do not have look directly into bright lights. The use of uplighters and other covering devices is appropriate.

1.61 Dimmer switch controlled luminaires may be appropriate in some instances.

1.62 Architects and engineers should also collaborate with the department artist and landscape designer to ensure services requirements are co-ordinated within the facility.

1.63 Luminaires should be manufactured and tested in accordance with the requirements specified in the relevant sections of BS EN 60598-1 and BS 4533. Their location should afford ready access for lamp changing and maintenance, but with the overriding requirement that the recommended standard of luminance is provided to the task area in all treatment rooms.

1.64 The number and location of luminaires connected to a circuit and the number of switches and circuits provided should allow flexibility in the general and local level of illumination, particularly in areas away from windows where daylight can vary significantly. Some areas of the department, which are likely to be unoccupied for long periods, may be suited to automatic/presence switching.

1.65 Generally, energy efficient luminaires should be used wherever possible. Intermittently and infrequently used luminaires may be fitted with compact fluorescent or incandescent lamps.

1.66 Where computer workstations are used, the lighting should be designed to avoid bright reflections on the screen and to ensure that the contents of the screen are legible and meet the Health and Safety (Display Screen Equipment) Regulations 1992. Further guidance is contained in the CIBSE Lighting Guide LG3.

1.67 The lighting of corridors, stairways and other circulation areas, which generally are areas not covered by Activity Data Sheets, should be in accordance with the guidance contained in HBN 40 – ‘Common activity spaces’.

1.68 Safety lighting should be provided on primary escape routes in accordance with HTM 2011 – ‘Emergency electrical services’ and BS 5266. Emergency lighting of control rooms should also be arranged in accordance with the requirements of users and the guidance in HTM 2011.

Illuminated signs

1.69 At each entrance of a controlled area of an X-ray imaging suite, a safety sign and a warning lamp must be provided in order warn people that they are entering a controlled radiation area and to comply with the statutory requirements for radiological protection (the 1999 Ionising Radiations Regulations). The warning lamp must give a clear indication in red when it is energised and may incorporate the legend “Do not enter”, visible only when illuminated. All warning lamps should have incandescent filaments energised from a suitable power source within the room and switched via appropriate devices interlocked with the operation of the diagnostic equipment.

1.70 Exceptions to this design requirement are where the means of access is interlocked with the equipment

and controlled directly by the staff, for example where outpatient changing cubicles are designed to be directly adjacent to the X-ray imaging room.

1.71 Other illuminated signs may also be required within the department. All such signs should be connected to essential supplies where necessary.

Controlled drugs cupboard

1.72 A red indicating lamp should be provided on each controlled drugs cupboard and, where appropriate, outside the doorway to the room in which the cupboard is located and at a continuously staffed location. The lamps should be interlocked with the cupboard and alarm system to give visual and audible indication at the continuously staffed location of unauthorised entry to the cupboard.

1.73 An indicating lamp denoting that the circuit is energised should also be fitted to each cupboard. The supply circuits for the lamps and alarm system should be derived from essential circuits. The cupboards should comply with BS2881.

1.74 Further information is contained in HTM 63 – ‘Fitted storage systems’. More general information is contained in the Department of Health publication ‘Guidelines for the Safe and Secure Handling of Medicines’.

Socket-outlets and power connections

1.75 Sufficient 13A switched and shuttered socket outlets, connected to ring or spur circuits, should be provided to supply all portable appliances likely to be used simultaneously. The installation of twin outlets should be considered where activities occur in juxtaposition. These sockets should not be connected to circuits that are used in conjunction with X-ray units, due to the possibility that these systems may “dump” considerable amounts of energy to earth. It is likely that some of these sockets will be used in conjunction with patient monitoring equipment. Care should be taken to ensure that sockets of opposite phase supplies are placed at least 3 m apart.

1.76 Switched socket outlets should be provided in corridors and in individual rooms to enable domestic cleaning appliances with flexible leads (9 m long) to operate over the whole department.

1.77 Appliances requiring a three-phase supply, or those rated in excess of 13A single phase, should be permanently connected to separate fused sub-circuits. The sub-circuits should be fed from the distribution board and terminate at a local isolator. Fixed appliances with a rating of less than 13A should be permanently connected to a double-pole switched 13A spur outlet.

The spur outlet should contain an indicating light, where appropriate, and a suitable fuse.

1.78 Depending on local circumstances, consideration may need to be given to the quality of the electrical supply to computers and other equipment. Much equipment has over-voltage and surge protection built-in, but susceptibility to harmonics and other supply distortion should be discussed with the manufacturer to establish the parameters required.

1.79 Additional power-factor correction should be built in as required. Advice should be sought from manufacturers/suppliers at an early opportunity.

1.80 Isolation switches should be provided adjacent to all engineering plant and equipment for use by maintenance staff.

1.81 Socket outlets in consultation/examination/treatment areas and wherever X-ray films are processed, reported on or stored, should be connected such that within each area a supply is available from at least two separately fused circuits of the same phase.

1.82 Socket-outlets should be connected to essential circuits in accordance with the guidance contained in HTM 2011 – ‘Emergency electrical services’.

Electrical supplies to diagnostic imaging equipment

1.83 The imaging performance and overall reliability of diagnostic imaging equipment can be severely compromised if the systems are connected to contaminated electrical supplies. This will also be the case where there is a higher than required impedance on the earth circuit measured directly back to the central protective earth of the hospital. It is therefore advised, as part of a risk control strategy, that, before the installation of new or replacement of old diagnostic imaging equipment, analysis of the proposed incoming power supply including the earth and neutral lines should take place. The analysis should take place for at least for 24 hours, during normal working hours, and look for surges, spikes sags and electrical variations in the earth. The data collected should be reviewed with the original equipment manufacturers to ensure that it meets their specifications in terms of tolerance values.

1.84 The electrical supply connections to all medical electrical equipment should comply with the requirements of BS EN 60 601-1-2:1993.

1.85 Diagnostic-imaging equipment should be installed to a WYE standard and to meet the standards of BS 7671 – ‘Electrical installations in buildings’ (IEE 16th Edition), including Guidance Note 7 – special locations, chapter 10, ‘Medical locations’ in its latest revision. In essence, the majority of diagnostic imaging equipment will require a three-phase supply up to 480V and 30A

per phase, at 50 Hz. In addition, a separate neutral line and earth connection will be required to meet the installation requirements. The majority of diagnostic imaging equipment is manufactured and originally tested outside the UK and is designed to meet the USA 60Hz system. Before the equipment is transferred to the UK, a 60 to 50 Hz conversion is made. The original equipment manufacturers have solved virtually all conversion problems, but, on the rare occasions that problems are observed at the electrical installation and commissioning stage, investigation may be required.

1.86 Advice on the power supply and requirements for fixed and mobile diagnostic imaging equipment is contained in HTM 2007 – ‘Electrical services – supply and distribution’. Individual project requirements should be discussed at an early stage with manufacturers/suppliers of equipment.

1.87 Individual project requirements, including the relative arrangements of rooms within the department, will largely decide whether a radial or ring type feeder system is appropriate. While lower circuit impedance favours the ring circuit, difficulty in looping heavy current cables at the terminals of switch-gear should be borne in mind. The sharing of final feeders between several X-ray diagnostic imaging rooms should take account of the diversity of usage, with particular reference to exposure duration and frequency and the provision of a clean electrical supply to meet manufacturer’s requirements. The lowest diversity is accorded to the equipment used for X-ray fluoroscopy/fluorography and interventional procedures. Power terminations within diagnostic rooms should be appropriately protected by a fused switch.

1.88 The earth connection at the power termination should be suitable for the functional earth requirements specified by the radiology equipment manufacturer, and be arranged to receive a direct connection from the earth reference terminal, which should be provided or designated in every diagnostic imaging room. The purpose, characteristics and performance criteria of an earth reference terminal in a diagnostic imaging room are described in the “protective earthing” section of the Department of Health’s specification document TRS 89 relating to the supply and installation of equipment for diagnostic imaging and radiotherapy equipment. This should also meet the requirements of the latest edition on the IEE 16th Edition of electrical wiring regulations BS 7671 – ‘Requirements for electrical installations’. The earth wire should be of copper, rather than steel wired armoured design, to minimise the impedance between any part of the equipment and the earth reference terminal. The provision of separate “earth mats” may be appropriate for some items of equipment where the impedance measured to the central protective earth of the hospital is higher than that specified by the

equipment manufacturer. They may also be appropriate where there is a requirement to maximise the reliability and imaging performance of the equipment. Routine checks should take place annually and a thorough testing should be undertaken at a period not greater than 5 years, as advised by guidance Note 3 of BS 7671 – ‘Inspection and testing’.

1.89 Numerous electrical interconnections are required between the separate components associated with a complete diagnostic suite installation. Conduit and cable trunking should preferably be installed by the electrical sub-contractor, to a layout satisfying the requirements of the original equipment manufacturer, who will normally supply and arrange for the installation of the interconnections. Some cables have limitations on maximum length and radius of bends, for example high-voltage cables.

1.90 While it is preferable for all the components associated with a diagnostic room to be located therein, the relative positions will depend on operational requirements and room features. Control consoles and control equipment cabinets, however, are usually located adjacent to or against perimeter walls. With these features in mind, the cable distribution may be accommodated in a perimeter floor duct located approximately 200 mm from the walls, from which spur ducts traverse the floor to island equipment or rise via wall-mounted units to terminate at cable trunking above the ceiling.

1.91 Floor trunking should be of the continuous-lid load-bearing variety of nominal minimum 75 mm screed depth. Changes in direction of trunking should be provided with an internal angle gusset. All trunking lids, when removed, should give total access, so that cables may be laid in, rather than drawn into, the trunking, without negating the possibility of drawing in individual cables during periodical maintenance by lifting lids only at angles or tees. Should it be necessary for trunking to pierce walls, there should be adequate straight sections on either side of the wall to enable pre-formed cable termination assemblies to be fed through such an opening without difficulty. There is a requirement to maintain fire barriers and integrity where trunking passes through designated fire compartments.

1.92 The surface finish of cable trunking visible within diagnostic rooms should be commensurate in quality with the equipment consoles, cabinets and overall clinical function of the suite as described for each modality in this guidance. Conduit or trunking routes piercing radiological barriers, for example diagnostic room perimeter walls, should be provided with adequate radiation shielding or dense in-fill material.

Electrical interference

1.93 Care should be taken to prevent mains-borne interference, electrical radio frequency and telephone

interference affecting physiological monitoring equipment, computers and other electronic equipment used here or elsewhere on the site.

1.94 In diagnostic imaging, there may be some cases where there is a requirement to site other electronics cabinets (not connected with the imaging system), mains power outlets or the earth reference terminal at least 1.5 m away from the X-ray generator cabinets and transformers. This may need to be undertaken to minimise the risk of interference to the imaging system and induction of voltages in the electrical earth.

1.95 Electrical products, systems and installations should not cause, or be unduly affected by electromagnetic interference and should comply with the Electromagnetic Compatibility Regulations 1992.

1.96 Guidance on the avoidance and abatement of electrical interference is contained in HTM 2014 – ‘Abatement of electrical interference’.

1.97 The Independent Expert group on mobile phones chaired by Sir William Stewart, produced a report published April 2000, advises that mobile phones should be switched off within hospital premises and signage should be prominently displayed.

1.98 Fluorescent luminaires should comply with BS EN 55015.

Emergency electrical supplies

1.99 Guidance on emergency electrical supplies is contained in HTM 2011 – ‘Emergency electrical services’, BS 7671 and Guidance Note 7, ‘Special locations’. The grade of standby lighting provision is shown on the Activity DataBase. Safety lighting in accordance with BS 5266 and HTM 2011 should be provided on primary escape routes.

1.100 Requirements for connection of individual circuits and items of equipment to UPS and/or standby generation systems should be discussed with users and with equipment suppliers. Items for consideration include potential discomfort and any medical implications for the patient, and the memory capabilities and reversion characteristics of the equipment.

1.101 The use of uninterruptable power supply units should also be considered for some units to protect against surges and spikes. Use is advised where there may be a significant risk to the patient in the event of power failure or where is either a significant single point of failure. For example, a surge or spike in a computer network may result in the transient disruption of power services and may have a considerable impact on the viability on the provision of a service. Further

considerations are listed below under the individual modality sections.

Personal alarm transmitters

1.102 Local security policies should determine at the planning stage whether or not staff are to be issued with personal alarm transmitters. If personal alarm transmitters are not “self-contained” then conduits and accommodation for transmitting/receiving equipment and propagating devices, such as induction loops and/or aerials, will be required to suit the selected system.

Security alarm

1.103 A security alarm activating switch or button may be required located unobtrusively, for example, at the reception desk and staff base. It should be connected to a continuously staffed area such as the hospital telephone switchboard on the porters’ room.

Staff location system

1.104 The hospital staff location system should be extended to include this department. Further guidance is contained in HTM 2015 – ‘Bedhead services’. There are particular advantages to the use of such systems in diagnostic imaging. For example, patient groups who have undergone interventional procedures have emphasised the value in continuity of contact with a familiar care team and individual members of staff.

Patient/staff and staff/staff call systems

1.105 The patient/staff and staff/staff call systems may be hard-wired or radio systems. In all cases they must be electromagnetically compatible, taking account of electromagnetic interference likely to be generated.

1.106 Patient/staff call points should be provided in all spaces where patients may be left alone temporarily, such as consultation/examination/treatment rooms and patient WCs. Each call unit should comprise a push button or pull cord, reassurance lamp and reset unit. The audible alarm signal initiated by patients should operate for one second at ten-second intervals, with corresponding lamps lit continuously until cancelled.

1.107 Staff/staff call points should be provided in all spaces where staff consult with, examine and treat patients. Call units should generally comprise a switch (pull to call, push to reset) and reassurance lamp. The audible alarm signal initiated by the staff should operate intermittently at half second intervals with corresponding lamps flashing on and off at the same rate.

1.108 A visual and audible indication of operation of each system should be provided, i.e. the staff base to give responding staff unambiguous identification of the

call source. Further guidance is contained in HTM 2015 – ‘Bedhead services’.

Telephones

1.109 Central telephone facilities for internal and external calls will normally be available and should be extended to serve this department. Telephones will normally be of the desk pattern.

1.110 Depending on local policy, at least one ex-directory line should connect directly with the local ambulance services control centre. It should have a distinctive bell, buzzer and colour or other distinctive marking.

1.111 Coin and/or card operated payphones and free phone for taxis, depending on local policy, should be provided in the main waiting area.

1.112 Self-contained intercommunication systems are relatively inflexible and limited in the extent of their economic application. Any subsequent modifications to them usually involve disproportionate cost. In only very rare instances can such systems be justified for functional or clinical reasons.

1.113 A properly planned telephone system will provide prompt intercommunication facilities between all extensions. Abbreviated dialling can be used for a range of frequently called extension numbers. Consequently, reasons for providing a separate intercommunication system should be clearly shown.

1.114 Further guidance on telephone systems is contained in HBN 48 – ‘Telephone services’ and HTM 2055 – ‘Telecommunications (telephone exchanges)’.

1.115 Phone connections may be required from each of the modality control consoles to allow remote monitoring of equipment by manufactures at their UK or foreign bases.

Intercom systems

1.116 Due to the character of the diagnostic techniques used within imaging services, it will be appropriate to provide intercom stations in addition to the telephone and call systems. These permit “hands-free” speech contact, either staff/staff, patient/staff or staff/patient. Consideration should be given to the local circumstances and treatment/imaging methods or procedures.

Data and equipment links

1.117 Conduits will be required for cables to interconnect electronic equipment. The extent to which these conduits should link all workstations in this department and the main hospital system or elsewhere will depend on the local policy for automatic data

processing. Conduits may also be required to link closed-circuit television between the control areas and treatment areas.

1.118 Data systems specific to diagnostic imaging include:

- PACS networking or mini PACS systems, including those necessary for RIS and HIS terminals, where appropriate;
- coaxial cabling e.g. from a modality to a laser printer or print manager/router/hub;
- reporting systems in the form of digital dictation units networked to secretarial offices.

CCTV

1.119 Closed-circuit television should be provided, where required, to monitor patients undergoing treatment in restricted areas. The interference to which such equipment may be subjected should be considered when it is specified, to ensure acceptable electromagnetic compatibility. Care should be taken in the positioning of monitors in order to preserve patient privacy.

1.120 Security closed circuit television may be required to interface to the whole hospital system.

1.121 CCTV systems may be required in certain examination rooms under the appropriate modality. Colour CCTV systems may be required, in order to monitor from a more remote location, from a control area, when they are undergoing general anaesthesia or sedation.

1.122 CCTV systems may also be installed into waiting areas and connected to monitors in staff circulation areas such as processing and staff rest rooms in order that they are able to oversee patients entering the department. This may be particularly useful where diagnostic imaging serves A&E.

Clocks

1.123 Clocks may be of impulse, synchronous or battery/quartz type, except in any anaesthetic or resuscitation room, where they should display "real time", "elapsed time" and have a sweep seconds hand.

Music and television

1.124 Conduits for television/video and background music system outlets should be provided to public areas, bed heads and treatment rooms.

1.125 The provision of an independent or independently-controlled music distribution system from

the rest of the hospital should be considered in light of local patient needs.

Lightning protection

1.126 Protection of the building against lightning should be provided in accordance with HTM 2007 and BS 6651.

Internal drainage

General

1.127 The primary objective is to provide an internal drainage system which:

- uses the minimum of pipework;
- remains water and air tight at joints and connectors;
- is sufficiently ventilated to retain the integrity of water seals;
- labels waste pipes that may contain radioactive waste or effluent.

General design parameters

1.128 The design should comply with the relevant British Standards and Codes of Practice, including BS EN 12056-2, the current building regulations and approved documents. General recommendations for spatial and access requirements for public health engineering services are contained in CIBSE Guide G, 'Public Health Engineering'.

1.129 The gradient of branch drains should be uniform and adequate to convey the maximum discharge to the stack without blockage. Practical considerations, such as available angles of bends, junctions and their assembly, as well as space considerations, usually limit the minimum gradient to about 1:50 (20 mm/m). For larger pipes, for example 100 mm diameter, the gradient may be less, but this will require workmanship of a high standard if an adequate self-cleaning flow is to be maintained. It is not envisaged that pipes larger than 100mm diameter will be required within interfloor or ground floor systems.

1.130 Provision for inspection, rodding and maintenance should ensure "full bore" access and be located to minimise disruption or possible contamination. Manholes should not be located within the department.

Chemical and radioactive contaminated effluent

1.131 Providing that there is adequate dilution and the silver content has been effectively recovered, the effluent can be discharged into the internal drainage system. Project teams are advised to establish the acceptable levels for silver and other processing chemicals at the

planning stage of a scheme, as they are subject to change.

1.132 The drain from the toilet and radioactive waste disposal sink associated with the diagnostic room where radionuclide imaging is undertaken will carry radioactive effluent. It must be sealed throughout its run to the main sewer and its route chosen with regard to the areas likely to be affected if leaks develop. It is recommended that drainage for this purpose should not be into a pumped system. The RPA or an appropriate expert in this area should be asked to undertake a risk assessment for releasing radioactive substances into the environment to ensure that members of the public are not subjected to excess risk. Designers must ensure that all risks associated with contaminated effluent are conveyed to the pipework maintainers, who in turn must implement procedures to ensure that members of staff are not exposed to potential risks from these substances.

1.133 At an appropriate early stage in the design process, project teams and local water authorities should discuss and verify the project proposals for the collection and discharge of chemical and possibly radioactive contaminated effluent. Local water authorities will probably advise on restrictions on the quantity and rate of discharge of such effluent into public sewers.

Transfer of equipment to installation site

1.134 The method used to bring diagnostic equipment into a department should need to be carefully considered. Although the majority of diagnostic imaging equipment is broken down into modules for transportation and then re-assembly on site, these modules can be large and in some cases have masses that exceed 1 to 2 tonnes. The equipment will usually be transferred in wooden crates, which has the effect of increasing the overall dimensions. It is therefore advised that architects and estates managers consider at early planning stages how the equipment will be transferred to the proposed site. Care should be taken over the width and height of doors, loading specifications for floors and the turning circles of the equipment.

CDM requirements

1.135 Throughout this guidance, detailed attention is paid to considerations of safety, risk control and the implications for design. The requirement to give such attention in building projects is embraced by SI 1994 No 3140 The Construction (Design and Management) Regulations. These are broadly based but ascribe particular and specific duties to both designers and others who contribute to the shaping of design solutions. The regulations were subject to technical

amendment in 2000 with a clarification on the statutory definition of a designer.

1.136 The primary duty is concerned with due regard to health and safety in design work. This includes a requirement to conduct risk assessments, with respect to both the product built and the process of its construction. In addition to an overall consideration of broad risk categories, the regulations also instruct on the need for safety and risk analysis at the detailed design level. There is a requirement to evaluate design options in terms of risk reduction and the cost of such, though a balanced approach with due consideration of many other factors is described as appropriate.

1.137 A large part of the design process must always consist of close collaboration and consultation with end-users of the new development and those responsible for existing buildings within the same or closely related institutions. The regulations may be interpreted as requiring broad care in respect of overall design and facility management, as well as technical alignment. There is a particular need to avoid solutions that may be technically acceptable but that are not compatible with organisational and operational requirements.

1.138 In all instances there are duties on the designer and planning supervisor, but those of the client or end-user must also be respected.

Radiation protection

1.139 The X-ray and radionuclide imaging suites within the department and any other rooms using ionising radiation should be designed to meet the requirements of the Ionising Radiations Regulations 1999.

Controlled area

1.140 Under the Ionising Radiations Regulations 1999, the examination room containing the X-ray tube or sometimes called an X-ray generator will be designated a controlled area. This is due to the average ionising radiation dose rate or exposure present in this area and access is restricted to authorised members of staff. It should be noted that radiation is only present when the X-ray tube is activated but codes of practice require the area to be controlled, on the basis of average dose rate present, in order to restrict access and control radiation exposure to both staff and patients.

1.141 If the X-ray tube is activated, as it may be for long periods in fluoroscopy/fluorography examinations, radiographers and radiologists should only remain in a controlled area if they are wearing protective clothing such as lead protective jackets, thyroid shields and lead glass spectacles. This may be necessary in the performance of their duties, such as operating the X-ray unit, clinically directing the procedure and caring for the patient during the procedure. All protective clothing

should be located outside X-ray fluoroscopy/fluorography rooms so that members of staff can protect themselves when entering a room during a procedure without necessarily having to interrupt proceedings.

Supervised area

1.142 The X-ray control area, formed by the radiation attenuating screen or provided as a separate room, will not, in the majority of circumstances, be part of the controlled area described above, but may be designated a supervised area under the 1999 Ionising Radiation Regulations.

1.143 Within a supervised area the average radiation dose rate will be less than that within a controlled area, but may remain slightly higher than that of non-designated and non-controlled areas. Access will be limited to authorised persons in a similar manner to controlled areas, but the supervised area may be accessed by a wider group of medical personnel under supervision of the authorised person.

1.144 In some instances, the technical room associated with X-ray fluoroscopy/fluorography suites may be designated a supervised area and accessed only by trained radiographers and X-ray engineers.

Non-controlled areas

1.145 Non-controlled public access areas must be shielded to allow only very low radiation exposure arising from the use of X-ray units. The limits of permitted exposure are controlled by legislation as interpreted and determined locally by the RPA.

1.146 In number of cases it may be necessary to have the control area non-designated, in terms of average radiation dose rate present, to allow members of the public to enter the control area during an examination. In this instance, the level of radiation attenuation provided by the construction of the screen may need to be increased and careful consideration given to the layout and geometry of the screen in relation to the position of other major items of equipment in the examination room. The purpose here is to reduce any scattered radiation into the control area in order to allow this area to be non-designated. The RPA, working with the manufacturers of the X-ray equipment and lead-lined screens, will advise on this area to a greater detail. This is of particular importance in fluoroscopy and interventional/angiography installations.

1.147 Other visiting professional medical staff groups may enter this area when accompanied or supervised by radiographers or radiologists for example. If they are in the controlled area during a procedure, they usually can remain, providing they are wearing protective

clothing and are under the supervision of an authorised person.

Structural and design considerations

1.148 The controlled area, usually the X-ray procedures room, must be bounded by ionising radiation attenuating construction, usually lead ply, barium plaster, or concrete forming the boundaries of the space. Alternative materials could be used for X-ray mammography as described in Chapter 10. As all X-ray rooms will be controlled areas as defined in those regulations, all defining structures, including floors and ceilings, must be radiation protected. The choice of construction materials for floors, ceilings and walls must be agreed with the RPA, who must also be consulted on overall radiation protection standards, including aspects of design and room layout.

1.149 Patient entrance doors into the room must be radiation shielded, and must open in such a way as to protect those entering into the controlled area. The shielding required will depend on the type of room or suite. This aspect of design will be an important part of the consultation with the RPA. There must be "Controlled Area" and "X-ray on" warning lights over the door, connected to the X-ray set power supply and generator described above.

1.150 In respect of the staff entrance to X-ray rooms from the control area, the need for a radiation protected door will depend on the route into the room, the use of shielded screens and walls separating the control area from the X-ray room and whether the control area is designated supervised or non-controlled.

Remote diagnosis services

1.151 All manufacturers of diagnostic imaging equipment now provide a modem or direct telephone connection to the main imaging or control workstation of the imaging modalities supplied. This facilitates the remote diagnosis of faults and supplements the site maintenance programme on the equipment installed. Diagnostic imaging companies can, therefore, discover and correct problems remotely. Alternatively, the manufacturer can establish the nature of the problem before the engineer attends on site thus reducing the down-time on the machine. Potential conflicts arise when the main imaging control workstations are also connected to RIS/PACS or HIS, as the configuration of this connection conflicts with DoH/NHS policies on data security and secure network connections.

1.152 It is a real advantage for the hospital to provide higher equipment uptimes and reductions in the cost of maintenance contracts, by using these remote diagnosis and repair facilities. Potential solutions, which allow

remote diagnostics and comply with relevant DOH/NHS policies, are briefly outlined below:

- a. use of the established NHS net through local or wide area networked nodes;
- b. the provision of routers and as part of PACS or RIS networks;
- c. the configuration of electronic firewalls on the main imaging console, thus preventing unauthorised access to patient data.

1.153 The method used to provide for remote access services for each of the diagnostic modalities, should be decided at an early project stage, as the building will have to be appropriately cabled and data/telephone connections integrated with the design of the diagnostic suites.

SECTION 2 – GENERAL X-RAY SYSTEMS

X-ray tube basics

2.1 The X-ray tube comprises an “insert” (an evacuated glass envelope containing the electrodes – anode and cathode) fitted within an oil-filled cylindrical metal housing or “shield”. The housing is lined with lead to reduce the emergence of unwanted X-radiation but has a port or “window” through which the useful X-ray beam emerges.

Mechanical ventilation

2.2 Waste heat is generated by the X-ray tubes, by the high-voltage X-ray generator cabinets and by other associated equipment and persons working in these rooms. If high-level roof lights are provided, they will need to be “dimmed-out” during discrete stages of the examination, limiting the possibility of natural ventilation. General-purpose X-ray rooms therefore require mechanical supply and extract ventilation to dissipate waste heat and to maintain comfortable conditions for staff and for patients.

2.3 According to the particular heating loads arising from the specific diagnostic equipment and from other design factors, it may be necessary for supply air to be cooled.

2.4 The use of mobile ceiling-suspended X-ray tubes necessitates a minimum clear height requirement of 3.1m over a large proportion of the ceiling area, and also necessitates the installation of a substantial support framework above the ceiling. Mechanical ventilation grilles are therefore likely to be installed at high level around the perimeter of the X-ray room, and to be served by ductwork located above lower ceilings in adjacent areas.

Lighting

Daylight

2.5 For the protection of people in adjoining spaces from the effects of radiation, the examination room should not incorporate any windows, although skylights or high level lighting may be provided depending on design and siting and the requirement to protect persons in adjacent areas from ionising radiation. If such skylights are installed, systems of work, local access rules and operational policies need to be put into place to avoid the risk to maintenance personnel working on roof-tops. Blackout blinds must be provided in such instances, in order that the radiographers can darken the rooms as required.

Artificial light

2.6 In most cases, the design and location of the light fittings will need to be integrated with the requirement for extensive ceiling tracks and support frames needed to support the movable ceiling mounted X-ray tube. The following are key requirements:

- a. patients under investigation who maybe lying on “patient” tables should not have to look directly up into bright lights;
- b. the movement of ceiling-mounted equipment should not unduly obstruct the light produced;
- c. variable levels of illumination should be made possible by the use of dimmer switches, to enable certain tasks to be performed. For example:
 - (i) a low level of lighting (“dim-light”) is required for a radiographer to clearly see the light beam diaphragm when positioning a patient and aligning the X-ray field. This level of light may also enable a member of the clinical team to review images on wall mounted X-ray viewers or on a computer workstation located within the control area;
 - (ii) intermediate general lighting is required for certain radiological investigations;
 - (iii) high intensity lighting is needed during equipment maintenance procedures.

2.7 The use of spotlights is not usually required for general radiographic X-ray rooms.

2.8 The construction of modular suspended ceilings enables modular ceiling panels and recessed lighting fittings to be interchangeable. When a suspended ceiling cannot be provided, it will be preferable to install lighting fittings at or near the junctions of walls and ceilings. If lighting fittings are at lower levels on walls, or near to eye level, they can cause an uncomfortable glare.

2.9 Mobile examination lamps should operate at extra low voltage, be totally enclosed and should be equipped with a heat filter. The temperature of external surfaces should be such as to avoid injury to patients and staff. These luminaires should comply with the requirements of BS4533 Sections 102 and 103.

Floor design for general X-ray imaging rooms (including support spaces)

2.10 In the provision of floors for diagnostic imaging equipment, traditional construction methods consisting of a concrete slab or sub-floor with a screed of normal thickness may not allow the flexibility needed when installing interconnecting cables between items of equipment. This failure may become apparent when equipment is renewed, an activity that may take place a number of times during the lifetime of a building or facility. This problem is not as acute now as it was ten years ago, because the equipment has become more modular, more compact, there are fewer interconnecting cables and the installation methods have been developed further the majority of X-ray manufacturers.

2.11 There is also the possibility that the function of the room may change. Because of this, the floor in the actual general X-ray room should be capable of supporting a total load of up to 5000 kg, although no single item of equipment is likely to weigh more than 2500 kg. Manufacturers and suppliers should be consulted on the likely weights of such equipment. The floor should permit easy installation of trunking, 100 mm in depth, with a minimum cross-sectional area of 150 cm² for cables.

2.12 Considering the above requirements, it is advised that standard floor construction methods are used when installing X-ray equipment for imaging and interventional equipment in the actual room itself. Other possibilities exist for the control area and other supporting facilities and these are described further below.

2.13 Diagnostic imaging and interventional facilities should be installed on the ground floor, as this reduces the complications of installing and transferring equipment to the designated space. If, however, imaging modalities, possibly as part of a department, need to be located on an upper floor, this can only be achieved at the expense of restricted storey height to the accommodation below. The load bearing capacity of the main hospital lifts may have to be increased in order to take the weight of the imaging equipment. Alternatively, large heavy lifting cranes may have to be used to transfer the equipment into the department. The radiation protection offered by the floors, walls and ceiling around the imaging examination room will have to be considered and discussed with the RPA at an early design stage. This may result in increasing the size of

the structural floor slab, for example, or the use of lead lining in the walls or barium plaster.

2.14 Floors with increased thickness of screed (over-slab) incorporate an increased depth of floor screed with a perimeter ring cable duct from which connections may be made to the generator, equipment racks and control console.

2.15 In the event of equipment being enhanced or renewed, additional cable trunking risers may be connected to the perimeter duct.

2.16 The perimeter ring duct needs to have a clear internal height of 100 mm and will normally be constructed of galvanised steel with a suitable flush-fitting removable lid. The floor finish should be continuous and sealed, but have a welded inset to delineate the position of the floor duct and access points.

2.17 This type of floor would, therefore, consist of:

- a. a continuous sealed floor finish;
- b. a minimum of screed depth of 75 mm to accommodate the trunking and cables used by the X-ray units. Ideally the same thickness should be used throughout the department to form single level floor;
- c. a separating membrane;
- d. a structural floor slab or a concrete sub-floor;
- e. a perimeter duct of 100 mm clear height and 150 mm minimum clear width.

2.18 The drying-out period for over-slabs of this nature is significant and may well be in the region of 25 weeks. Account of this should thus be taken at an early stage in the construction programme. However, certain types of over-slabs laid by specialist contractors offer substantially reduced drying-out periods.

2.19 To ensure ease of access for wheelchairs, trolleys and beds, the floor surface should be at the same level as the surrounding corridors. For hygiene and ease of maintenance, the floor finish should be impervious to fluids.

Control and support machine room options

2.20 A further option exists for the installations of floors in separate machine and control rooms associated with the use of specific imaging modalities.

2.21 In both options described below, there should be consultation with the X-ray equipment manufacturers before the installation of these types of floors. In some instances, there may be concerns regarding infection

control and decontamination of lightweight modular access floor types.

Lightweight modular access floor

2.22 This option allows for a hollow floor, which, in principle, offers complete flexibility for cable runs between the control and equipment and examination rooms and is similar in concept to a floor associated with a computer installation.

2.23 This type of floor would, therefore, consist of:

- a. a continuous sealed floor finish;
- b. a proprietary or similar modular access floor with a recommended clear depth of 200 mm formed with standard floor panels, normally 600 mm square, on adjustable screw jack supports;
- c. a structural floor slab or a concrete sub-floor with power-floated finish.

2.24 It may be necessary to give consideration to the detailing of concrete or steel supports to carry the loads of any large items of equipment, possibly modality control workstations. A base plate may be required, necessitating the trimming of floor panels around it. It is also particularly important to consider the movement of equipment during installation and how large items of X-ray imaging equipment may be moved through a support area.

X-ray tube support

2.25 X-ray tube supports can be floor-to-ceiling or ceiling-suspended, with tracks as appropriate. The type chosen will depend on the radiological application. Care should be taken to ensure that the range of all the movements of the tube is sufficient for the techniques envisaged. The tube mounting must permit the X-ray tube to rotate about its long and short axes and around the vertical column. The facility to lock the X-ray tube rigidly in any selected angle at a pre-selected film focus distance is essential. The types of tube support are:

- a. a floor-to-ceiling column which may be either static or movable on floor and ceiling track(s); it comprises a vertical column with a counterpoised cross-arm for the carriage of the X-ray tube and mounting;
- b. a ceiling-mounted tube support comprising a vertical telescopic column suspended from a carriage assembly running on ceiling tracks longitudinally, laterally or both.

Mechanical support of ceiling-suspended X-ray tubes

2.26 The majority of general X-ray diagnostic rooms contain ceiling-mounted X-ray tubes. To support the

overhead equipment and its services, it is recommended that a load-bearing modular steel grid should be hung from the structural floor slab of the storey above. This will provide built-in flexibility for the choice and location of equipment, both initially and in the subsequent life of the building. The grid should be integrated with the suspended ceiling, concealing primary services distribution, and designed so that the tracks can be mounted wherever required at the level of the suspended ceiling. The latter should comprise demountable modular tiles with interchangeable recessed modular lighting fittings, which are capable of being placed in any desired position so that they are not obstructed by the equipment.

2.27 The ceiling-mounted general X-ray equipment that is currently available can impose a moving load of up to 500 kg and a possible horizontal force of up to 600 kg. The maximum deflection of the supporting tracks when loaded must not exceed 1.5 mm, irrespective of the location of the carriage. Project teams are advised to consult the suppliers or manufacturers about the weight factors of all equipment, as they can vary considerably.

2.28 The structural support grid must be designed to ensure that the X-ray tube is unable to expose when placed in the control area of the diagnostic imaging room. This can be achieved by constraining the design of the ceiling suspended grid or by placing small rubber stoppers at discrete points of the grid to prevent the X-ray tube moving into a position where it could expose in the control area.

2.29 In general X-ray imaging rooms, there must be a clear minimum height of 3.1 m (over the whole room) between the finished floor level and the underside of the support grid for the direct suspension of radiological equipment to enable certain types to be operated over their full working range.

Construction of walls and radiation protection

2.30 There are two types of wall in diagnostic rooms, one of solid construction and the other hollow-core partitioning. The latter provides flexibility in the use of rooms and enables services to be installed within them. Both types of wall must provide radiation protection to the standards required to ensure that adjacent spaces are protected from ionising radiation. The structural protection required will depend on a number of factors, including the workload, energies of radiation used and the reduction in radiation exposure levels required to protect staff and the members of the public in adjacent areas. As a general guide only, 2 mm of lead equivalence is usually adequate to provide sufficient radiation protection in general X-ray rooms and this can be achieved by the use of lead ply and barium plaster. The RPA should be consulted when determining requirements. Ducts, pipes, and holes through walls

should be radiation protected by the use of “dog-legs” or other devices. Project teams should again consult the RPA for advice on the use of these devices. Walls should have a load-bearing capacity for equipment, in particular for the provision of radiation protection equipment such as lead coats, jackets etc. This requirement may involve a side thrust of up to 200 kg and point loads of up to 100 kg. Walls should be flush and without structural protrusions.

SECTION 3 – SPECIAL ENGINEERING REQUIREMENTS FOR CONVENTIONAL AND REMOTE FLUOROSCOPY SYSTEMS

Floor and ceiling loading

3.1 The floor design will be similar to that described for general X-ray suites. However, the installation of this equipment includes a ceiling suspended X-ray tube and floor mounted conventional or remote fluoroscopy equipment. This equipment will be far heavier than the patient couch for the standard general X-ray room and this should be taken into consideration at the early planning stages. The weight of the main fluoroscopy equipment will up to 2000 kg or 2 metric tonnes, with the weight of the cabinets up to 400 kg.

Environmental considerations

3.2 The heat loads in the suite from the equipment will be far higher than those for general X-ray units and therefore the provision of air conditioning may be required to maintain staff and patient comfort. The actual specifications should be obtained from the manufacturers and the room planned to meet the worst case requirements. The equipment should be operated between temperature ranges of +15°C and +30°C with relative non-condensing relative humidity of between 30% and 75% and pressures of between 70 kPa and 106 kPa.

3.3 Care should be taken over the magnetic field environment around the equipment, as the function of the image intensifier can be downgraded by fringe fields from MRI scanners.

Power consumption

3.4 The power consumption will depend on the type of generator procured for use with the X-ray system and will depend on the clinical application. The nominal ratings for the X-ray generators are between 30 and 80 kW, instantaneous power for 0.1 seconds. For these types of examinations and equipment it is likely that the specifications will require a generator rated between 65 and 80 kW and the larger of these units will consume 145 kVA on a transient basis during fluorography exposures.

Lighting – dimmable for use with monitor screens

3.5 Light fittings must be located with reference to the positioning of the X-ray table and tube stand. Very carefully designed locally variable light level control must be provided in the imaging room. Poor lighting design that, for example, fails to eliminate reflection on monitoring screens or allow local dimming can adversely affect fluoroscopic imaging perception.

3.6 Colour corrected lighting should be provided in all patient areas and in the image review room workstation. Level control and the avoidance of reflections in monitors in the image review room workstation are essential.

3.7 Emergency lighting and power should be provided in the catheter laboratories, recovery area and generator/computer rooms.

Electrical supplies and UPS provision

3.8 Some types of fluoroscopy equipment may store images to volatile RAM within the control computer during the conduct of the procedures. Therefore, a power supply failure during an examination may mean that images acquired during the procedure may be lost. Where this occurs, there may be a requirement to repeat the examination or procedure, which, amongst a number of other factors, will increase the radiation dose to the patient. It may, therefore, be necessary, as part of a risk control and overall un-interruptable power supply strategy, to wire the power supplies of the control computer separately from those of the X-ray system, whilst ensuring that systems have a common earth. The use of an un-interruptable power supply incorporated into the circuit to the control computer would mitigate against data loss in the event of a power supply failure and allow the radiographer to print the images or send them to another computer workstation. The actual X-ray unit may be powered using emergency supplies during a primary power failure, but the decision to undertake this process should be part of an overall risk control strategy. It should be noted that any switch back following the re-establishment of the primary supply (from emergency) should be undertaken manually, to avoid any members of staff mistakenly assuming that the system has powered down.

SECTION 4 – SPECIAL ENGINEERING REQUIREMENTS FOR INTERVENTIONAL AND CARDIAC IMAGING SYSTEMS

Floor and ceiling loading

4.1 The floor design will be similar to that described for general X-ray systems. Careful consideration should be given to the route of cable runs between the generators and electrical supply cabinets to the X-ray and the patient couch, which will usually incorporate powered movements in all three orthogonal directions.

4.2 The floor and ceiling loading for this type of equipment will be higher than for general X-ray units and conventional/remote fluoroscopy equipment as described above. The C-arms where the image intensifiers and X-ray tubes are mounted may weigh up to 2 metric tonnes, and consideration of this factor should be given in overall planning and structural design terms.

Environmental considerations

4.3 Full air-conditioning and filtration should be incorporated into the fluoroscopy suites and recovery area, and should be able to be manually controlled from within each area. This should be connected to a different electrical circuit to that used for the imaging equipment. In general terms, a maximum air change rate of between 12 and 15 air changes per hour are seen as appropriate to control room temperature and infection in the examination room.

4.4 The equipment should be operated between temperature ranges of +15°C and +30°C with relative non-condensing relative humidity of between 30% and 75% and pressures of between 70 kPa and 106 kPa.

4.5 Care should be taken over the magnetic field environment around the equipment, as fringe fields from MRI scanners can downgrade function of the image intensifier.

Lighting – dimmable for use with monitor screens

4.6 See paragraphs 3.5 to 3.7 of this Appendix.

Power consumption

4.7 Generators for use with interventional fluoroscopy equipment will usually be rated at 80 kW over 0.1 seconds and thus a maximum power consumption for the system of 145 kVA can be expected.

4.8 Systems for cardiac angiography are fitted with a generator of 100 kW rating, over 0.1 seconds. Thus, the maximum transient power consumption will be 185 kVA.

Electrical supplies and UPS provision

4.9 In the event of a electrical power failure power during a procedure, electrical power to the system and associated support services should be maintained, in order to allow the clinician to remove any catheters or guide wires from the patient under imaging control. This can usually be undertaken using the fluoroscopic capabilities of the system and in this respect the maximum power required by the X-ray generator will be of the order of 2kW. In addition, to support this objective, power supplies will need to be maintained to the examination room monitors, imaging computer and associated control electronics. The use of UPS or emergency supplies should reflect the overall risk control strategies used in the installation of the equipment whilst in consultation with the original equipment manufacturer.

Maintenance – split cabinets

4.10 If the power control and generator cabinets are moved a relatively long distance from the actual X-ray unit due to space constraints, for safety reasons the company supplying maintenance and servicing to the X-ray systems may insist that they have two engineers on site during an inspection or repair. Generally, X-ray companies will insist on this measure when it is not possible, under any circumstances, to view the X-ray unit from the technical room. This may increase the price of any maintenance contract for the provision of routine inspections and repairs. This should be considered at early planning stages and the position of electrical cabinets identified at an early stage.

SECTION 5 – RADIONUCLIDE AND POSITRON EMISSION TOMOGRAPHY IMAGING SYSTEMS

Heating and ventilaton

5.1 The expensive crystal detector within a gamma camera or PET imaging system can be damaged or cracked beyond repair if there is too rapid a rise or fall in temperature (>2°C/hour) or other environmental conditions. The environmental conditions in the examination room must be appropriately controlled to manufacturer tolerances and full air-conditioning provided. This will ensure that the equipment operates at optimum performance levels and may also reduce overall downtime. Consideration should be given to the provision of an alarm system that would be activated in the event of failure of the air-conditioning system or when the environmental conditions are outside those tolerances recommended by the manufacturer. For the majority of detectors, the temperature should remain between 20 and 22°C with a non-condensing humidity of between 40 and 60%. These figures will vary between manufacturers and should be checked carefully before installation. The doors to the gamma camera room should remain closed for as much time as possible and

be equipped with access to controlled locks or systems to prevent unauthorised out-of-hours access.

5.2 It is essential not to have windows that open directly to the inside or outside of the examination room. If a window already exists, it must be doubled glazed to prevent temperature fluctuations and securely fixed to prevent unauthorised opening. Curtains or venetian blinds must be used on any window frame, as patients are required to partially undress and sit upright on the exercise machine for some studies. Under no circumstances should direct sunlight be allowed to fall on to the gamma camera. If a window is included in the design, there are also issues concerning radiation protection and limiting radiation exposures in adjacent spaces.

5.3 If radionuclide imaging examination procedures are to include the use of inhaled aerosols labelled with technetium, separate ceiling mounted air extraction facilities, discharging to the open atmosphere, should be provided. The location of the discharge duct should be reviewed with the RPA and subject to COSHH assessment. This is to minimise the contamination risks within the examination room, in particular the risk of contaminating the face of the gamma camera, since this may have a direct impact on clinical image quality. If a radioactive gas, such as krypton, is used as an alternative to aerosols, it is not usually necessary to make provision for extract ventilation, as this radioactive substance has a very short half-life of approximately 10 seconds.

5.4 The air-conditioning system needs to supplement the air flow with a fractional intake of filtered air from outside, in order to clear the stale air and odour originating from patients or from chemicals used for cleaning and disinfecting following the investigation on an MRSA(+ve) patient. The air in the room must be dust-free for protection of the camera mechanics and computer hard disks.

Electrical supply requirements

5.5 This must be a dedicated (clean) supply direct from the hospital's main incoming distribution panel, with earth reference terminal. The electrical supply to the equipment should not be shared on ring mains that generate transient high sudden loads (for example X-ray units, or motors to the lift etc) as this may cause a failure of the equipment, unreliability or drop in the performance of the imaging system.

5.6 The specific power required by each camera will depend on the camera. This can be a 30A dedicated single-phase 240V mains supply or a three-phase 30A (total) supply. It is essential to meet manufacturer specifications in terms of tolerance values for frequency and power.

5.7 Isolating switches to these cameras must be within the camera room itself, for safety and for access by the service engineer.

5.8 Each camera room should have adequate 13A sockets for PCs, monitors, and physiological measuring devices. A minimum of five double 13A sockets located at various positions in the camera room are required. These should be off a separate mains ring, not from the supply to the imaging system or those used to power the X-ray systems as stated above.

5.9 Sockets must be easily accessible for easy connection to the monitoring equipment needed by patients with critical care requirements. They may also be needed for portable equipment such as the Technegas generator or engineering test equipment.

5.10 There is a case for some of these sockets to be of the suspended type in the vicinity of the patient couch, to avoid the risk of accidents caused by tripping over mains cables trailing on the floor.

5.11 A common earth (with a single earth reference terminal) is essential for all mains supplies in each camera room, to avoid electrical shocks between equipment fed from different mains outlets

Fixtures and fittings

5.12 The fixtures, fittings and overall finish in radionuclide and PET imaging suites are described in the main text.

Special drainage requirements

5.13 Consideration should be given to shielding the trap from any sink that has been designated for the disposal of radioactive waste within a radionuclide imaging suite. Particular consideration should be paid to the disposal sinks in the radio-pharmacy and the injection room. In these cases, lead sheets could be laminated around conventional plastic fittings.

5.14 For all sinks designated for the disposal of radioactive substances it is advised that "running traps" are utilised instead of the bottle traps normally provided.

5.15 The drainage from designated WCs and sinks etc should be separated from other sinks to minimise back-flow to other drains caused by blockages.

5.16 Plastic pipes become radioactive waste if continually exposed to radioactive substances, therefore other non-absorbent materials should be used until the waste pipe reaches the main sewer or where there is sufficient dilution of the radioactive waste. This should be determined by a suitably qualified RPA.

5.17 Waste from the designated patient WC will also be radioactive and drains should also be designated and labelled accordingly.

5.18 If possible, drainage systems from disposal sinks and WCs should allow for maximum dilution as quickly as possible. They must be made of porcelain instead of stainless steel, as this material absorbs some radioactive species of isotopes that may be used in radionuclide imaging investigations.

5.19 All designated drain runs carrying radioactive waste should be labelled appropriately at all access points, up to, either the perimeter of the hospital site, where it enters the main sewer or the point of sufficient dilution as determined by the RPA.

5.20 The route of such drainage runs should not pass areas used by vulnerable groups of patients before the point of sufficient dilution.

5.21 The drainage from sinks or toilets should not pass close to the gamma camera, as this may cause instability of the camera during imaging or excessive noise on the images acquired.

Security

5.22 Senior radiographers working with radioactive substances are required for safety, security and regulatory reasons to keep accurate records of all the substances stored and used in the department, or entering and leaving the department. Radioactive sources have to be stored in secure environments. Routes for the delivery of radioactive substances should also be identified to avoid sources being accessed by unauthorised persons.

SECTION 6 – ULTRASOUND SYSTEMS

Electrical supplies

6.1 Most ultrasound systems are powered by a single-phase 240V supply and are commonly powered using standard 13A sockets. The exact electrical installation requirements should be checked with the original equipment manufacturer before procurement and delivery of the equipment, in order that changes to the installation can be undertaken, if required.

6.2 A special challenge exists for the provision of clean electrical supplies earth to ultrasound units for the following reasons:

- a. the majority of imaging transducers supplied with the base unit will use the earth as a reference value when being used for imaging purposes. Any contamination of the earth may cause the ultrasound equipment to become unreliable or cause degradation in diagnostic imaging performance. For example, ultrasound units may be susceptible to spikes and surges on the earth circuit that may be created when the energy from uncompleted X-ray fluorographic exposures is “dumped” to a common earth circuit. The earth circuit for ultrasound units should be separated from those provided for X-ray units, so each ultrasound room should be fitted with a common earth reference terminal as specified in TRS 89.

All power outlets or sockets in the ultrasound room should be connected to this common earth, to minimise the risks of electrical potentials developing between different items of equipment attached to the patient;

- b. as for radionuclide imaging systems, the electrical supplies to the ultrasound unit should be provided using a different supply from the transformer to items of equipment that may generate transient high loads, as this may cause failure of the equipment or unreliability. A single un-interruptable power supply may be installed within a conveniently located and well ventilated electrical cupboard or riser, to possibly serve all relevant equipment, including computers and ultrasound units. Alternatively, separate units could be provided for individual ultrasound units. Dedicated outlets for use with ultrasound machines should be labelled appropriately throughout the ultrasound cluster of units.

6.3 The above may be considered within a wider risk control strategy to provide either a continuous or core hours only ultrasound imaging service.

Heating and ventilation

6.4 See [paragraphs 5.1 to 5.4](#) of this appendix.

Lighting

6.5 See paragraphs 3.5 to 3.7 of this appendix.

Emergency electrical supplies

6.6 The requirement to maintain a continuous imaging service during a power failure will depend on local circumstances and the reliance on ultrasound to provide a modern diagnostic imaging service. The provision of UPS devices may ensure that the units will probably not fail during the transient phase before any emergency generator is brought into service.

6.7 Where an ultrasound unit is used to undertake interventional procedures, the power to the unit will need to be maintained to allow the clinician to complete the procedure or bring it to a satisfactory conclusion without subjecting the patient to undue risk.

SECTION 7 – COMPUTED TOMOGRAPHY SCANNERS

Heating and ventilation

7.1 The general heating requirement for a CT suite will be as for any area occupied by patients in examination gowns rather than outside clothing.

7.2 A conveniently sited manual override or time restricted switch should be provided so that a local heating circuit can be activated promptly in the event that the CT suite is used at night or over the weekend.

7.3 All parts of the CT suite will require mechanical ventilation. Particular care is needed for the CT scan room itself and the associated control room. In these areas, the system must provide temperature and humidity control that meets the specific environmental needs specified by the manufacturer of the CT system. In general terms, this will be 18–24°C with non-condensing humidity control normally in the range 30–60%. The heat yield in the imaging room itself will be typically 5–15 kW depending on the number of persons present during an interventional procedure, for example, and the use of multi-detector scanners.

7.4 In dedicated imaging CT scanning rooms, thought may be given to the possibility of a switchable medium rate air change (10 air changes per hour) system, which will permit the clearance of odours to better accommodate patient comfort when fungating tumours are examined.

Electrical services

7.5 Between the control workstation and the CT scanner there will be a requirement for significant data, control and electrical connections. A facility needs to be included when designing these suites in order to connect these devices.

Lighting

7.6 All light services should have suitable colour rendering or temperature so as to make them usable for clinical applications, particularly where anaesthetics are in use.

7.7 For lighting within the CT scanner room should be multi-switched, by the use of a dimmer device, to give variable levels of illumination for patient comfort and to permit servicing of the equipment where high light levels will be needed.

7.8 Where interventional uses are contemplated, the provision of a minor procedures lamp will be necessary. Ceiling-mounted lamps are frequently considered to be more suitable and avoid taking up valuable floor space.

7.9 General lighting within the control room and, possibly, the laser-imaging room, reception office, reporting room and management office should be in accordance with current CIBSE guidance** for use with display systems. It is important for the control room have variable light levels, again with multi-switching.

Power supply for CT scanners

7.10 Electrical supply quality is a critical consideration for quality control and reliability in CT scanning. The monitoring of power supply sources should always be undertaken when the installation of CT equipment is contemplated. Whilst the majority of equipment will work well at the levels determined in the power supply regulations (see Appendix 4), some manufacturers will make supplementary stipulations within their site planning guides or detailed technical specifications. The use of power regulators, power filters and isolating transformers may be necessary in individual instances.

7.11 CT scanners may not require an additional technical or machine room as for MRI and some X-ray fluorography systems. The ancillary electronics or power distribution unit (PDU) for the majority of new CT scanners may be contained in a box that is only 1–2 m³. This can usually be installed in the CT examination room.

7.12 This will not apply for CT scanners procured under second hand replacement programmes where the requirement to install a number of ancillary items of equipment may be necessary.

7.13 Input impedance values are critical and will be specified by the manufacturer in installation manuals. All systems will require three-phase power supply with neutral and earth delivered on a five wire strategy complying with the requirements of BS 7671 the IEE Wiring Regulations 16th Edition. Individual power

** CIBSE guidance being updated

demands vary with machine design but will be up to a maximum of 100 kW when operational, with average loads of 30 kW.

7.14 Many modern systems may utilise un-interruptible power supplies in order to maintain the continuous operation for data protection on the computer systems incorporated into CT machines. The supplier or manufacturer must be consulted on the circuitry options, which can be employed for UPS applications.

7.15 In cases where power supplies cause excessive electrical interference that affects the operation of the equipment, power conditioning devices can be installed. These devices can vary in size and installation requirements, depending on the device.

Powered imaging contrast injector

7.16 A powered contrast injector will almost certainly be required within the CT examination room for the remote administration of contrast media by radiographers from the control room. The electrical power supply may be directly via the power distribution unit (see above) and controlled from the operator's console. These devices are of either floor or ceiling mounted articulating arm design and may need to be positioned either side of the patient when administering contrast media.

Structural radiation protection

7.17 In order to acquire a CT image, a much higher X-ray dose is used than that in general X-ray imaging. The X-ray energies used are also much higher than those used in fluoroscopy or general X-ray. As a result, the level of structural shielding required is much higher in a CT examination room than in other types of diagnostic imaging rooms. The installation of multi-detector units, spiral acquisition techniques and use of extended working hours may necessitate a further increase the shielding required by some departments. As a guide, the shielding may consist of between 3 and 4 mm of lead or equivalent thickness in other types of material when measured at energies of about 130 kV.

Vibration problems

7.18 The image quality of the scans can be reduced if the gantry is exposed to levels of vibration that are beyond the tolerance levels stated by the manufacturers. Ideally, the CT scanner should be located on the ground floor of a hospital building.

SECTION 8 – MAGNETIC RESONANCE IMAGING SCANNERS

8.1 There is a broad range of specific engineering issues that arise with the proper implementation of MRI scanners for imaging services applications and, indeed, more generally. The key points are described below.

Heating and ventilation

8.2 The general heating requirement for an MRI suite will be as for any area occupied by patients in bed clothes or examination gowns rather than outside clothing.

8.3 A conveniently sited manual override or time restricted switch should be provided, so that the local heating circuit can be activated promptly in the event that the MRI suite is used at night or over the weekend. It is likely that such use will be associated with the need to support the urgent treatment of a patient.

8.4 All parts of the MRI suite will require mechanical ventilation. Particular care is needed for the MRI scan room itself and the associated control room. In these areas, the system must provide temperature and humidity control which meets the specific environmental needs specified by the manufacturer of the MRI system. In general terms this will be 18–24°C with non-condensing humidity control normally in the range 30–60%. Similar restrictions will apply in the auxiliary technical room, though the heat yield in that room will be higher than elsewhere in the suite and should be anticipated as being between 10–20 kW. The heat yield in the imaging room itself will be typically 5–10 kW. In dedicated Imaging MRI scanning rooms, thought may be given to the possibility of a switchable medium rate air change (6 to 12 air changes per hour) system, which will permit the clearance of odours so as to better accommodate patient comfort when fungating tumours have been examined.

8.5 Whilst the Dewar containers used for the cryogenic gases are of the highest quality, there is nevertheless a possibility of some leakage. Leakage of helium or, in exceptional cases with old equipment, nitrogen, may lead to a build up in the atmosphere within the scanning room itself, which in turn may tend to exclude the oxygen and carbon dioxide essential to normal breathing. Accordingly, an oxygen monitoring device, which gives both a visual and sound alarm within the control room should leakage depress oxygen concentration, must be included in the MRI scan room. It is recommended that this system be independent of any similar system already incorporated into the MRI machine itself.

8.6 The possibility of a planned or emergency quench has been discussed earlier in this section. Such a contingency requires a separate low resistance air or

gas duct, venting to the external atmosphere at a safe discharge point, such that the gases released would be unlikely to re-enter the scanning building or any adjacent built environment either directly or through some form of ducting. The design of the duct varies slightly with the design of the MRI system, but all will require that the structure ensures that entry of water into the duct is precluded. Water contamination can lead to a build up of debris or icing during the winter months, inhibiting the proper operation of the duct.

Chilled water supply and cold-head requirement

8.7 The MRI equipment may require a closed circuit chilled water supply for the cooling of gradient coils associated with the scanner gantry. In addition, all MRI systems, excluding those that are non-cryogenic, will require a cold head or, alternatively, a heat pump intended to minimise helium loss and assist in gas recovery. These devices require the location of a compressor/pump in an area where the noise of its operation can be reasonably insulated from adjacent occupied areas and waste heat can be readily dissipated.

8.8 The compressor may be chilled by a closed water supply, which should have an automatic switch over to mains water in the event of failure of the chiller unit. These units have large space requirements and may need space in a plant room.

8.9 For resistive or electro-magnetic systems, a chilled water supply for general cooling will be needed. The volumes required are large and the dissipation ratings may be as high as 40kW. The specialist advice of the MRI system manufacturer will be needed and should be obtained at an early stage in design of the suite.

Lighting

8.10 All light services should have suitable colour rendering or temperature so as to make them usable for clinical applications, particularly where anaesthetics are in use.

8.11 AC light sources may also upset the image quality produced by some types of MRI scanners. As there is also a significant risk of RF interference and a risk of problems from the standing magnetic field, the use of DC power supply lighting is to be preferred over conventional AC systems. Care should be taken to ensure that the light fittings and the sources are MRI compatible.

8.12 Lighting within the MRI scanner room should be multi-switch, to give variable levels of illumination for patient comfort, and to permit servicing of the equipment, where high light levels will be needed.

8.13 Where interventional uses are contemplated, the provision of a minor procedures lamp will be necessary. Again, this will need to be MRI compatible and will ordinarily require a DC power supply. Ceiling mounted lamps are frequently considered to be more usable and avoid taking up valuable floor space.

8.14 General lighting within the control room, technical equipment room, laser-imaging room, reception office, reporting room and management office should be in accordance with LG3, the current CIBSE guidance** for use with display systems. It is important that the control room has variable light levels again with multi-switching.

Power supply for MRI scanners

8.15 Electrical supply quality is a critical consideration for quality control and reliability in MRI scanning. The monitoring of existing power supply sources should always be undertaken when the installation of MRI equipment is contemplated. Whilst the majority of equipment will work well at the levels determined in the power supply regulations (see Appendix 4), some manufacturers will make supplementary stipulations within their site planning guides or detailed technical specifications. The use of power regulators, power filters and isolating transformers may be necessary in individual instances.

8.16 Input impedance values are critical and will be specified by the manufacturer in installation manuals. All systems will require three-phase power supply with neutral and earth delivered on a five wire strategy complying with the requirements of BS 7671 the IEE Wiring Regulations, 16th Edition. Individual power demands vary markedly with machine design, but will be in the range 20–60 kW when operational, with stand-by loads between 5 and 15 kW. In the case of cryogenic units the start up phase will require higher currents and special engineering requirements apply.

8.17 Many modern systems utilise uninterruptible power supplies in order to maintain the continuous operation of cold heads and also for data protection on the computer systems incorporated into MRI machines. The supplier or manufacturer must be consulted on the circuitry options, which can be employed for UPS applications.

Specialised machine wiring

8.18 Normally, the services contractor will take responsibility for the power supply wiring and associated earth up to an isolator cabinet(s), usually equipped with a remote isolating switch. Beyond this point, specialised wiring will be used for the internal power supply, data lines etc., of the MRI systems. This wiring will be supplied by the MRI manufacturer/supplier and is usually

** CIBSE guidance being updated

installed by that company. Control and data trunking should be provided between the control room, laser imaging room and the reporting room suitable for data distribution.

Provision of an earth circuit

8.19 All aspects of the electrical installation of the scanner should be in compliance with the current edition of the IEE Electrical Wiring Regulations. In addition, the MDA document TRS 89 specifies the need for an earth reference terminal to be located adjacent to the examination room.

8.20 Particular difficulties arise with MRI, since the equipment has considerable sensitivity to any contamination of the neutral or earth lines. Where the earth circuit also supplies devices such as a linear accelerator and X-ray sets, the contamination of the earth circuit is likely. For this reason, consideration should be given to the provision of a low impedance direct earth circuit, normally connected to an earth mat and spike arrangement local to the MRI itself. In this instance, it may be possible to ensure that the impedance on the entire earth path, that is from machine to earth origin, is below 0.5 Ω (ohms) and ideally approaches 0.1 Ω .

Fire safety

8.21 General advice on fire safety including guidance on additional fire precautions required in MRI suites is contained in HTM 83. It is essential that the scanning room itself and any other area subject to a magnetic field intensity greater than 0.5 mT should not be used as a fire escape route.

Safety and environmental needs

8.22 MRI systems pose a number of special safety and environmental considerations which are further exacerbated when these machines are routinely used for imaging care or where minimal invasive therapy is involved. These specific hazards are dealt with briefly below:

Use of cryogenic gases

8.23 These will be delivered to site, by one of a small number of UK based suppliers, in a large volume duo, typically 500 litres, and taken to the MRI room for delivery to the MRI gantry mounted duo itself, through a cryogenic transfer valve. The delivery point and route of access through the hospital building to the MRI scanning room should be considered carefully in safety terms. Whilst accidents with cryogenic material have been rare in UK hospitals, the consequences of leakage are significant in safety terms. It is considered advantageous to avoid routes that go through highly occupied areas or where floor ceiling and ventilation are poor.

8.24 The MRI system itself is likely to be delivered in a partly pre-cooled state, so it will contain several hundred litres of cryogenic helium. Accordingly, precautions in terms of leakage of this material apply equally to the delivery of the system.

8.25 The stray magnetic field arising from the MRI system has been discussed in earlier parts of this section. Essentially, however, it offers two challenges:

- a. according to MDA guidance, the fringe field above 5 gauss or 0.5 mT may give rise to disruption of function in cardiac pacemakers, causing a hazard to the health of patients. Some independent authors suggest that mode switching can occur in such pacemakers at 3 gauss or 0.3 mT;
- b. much electronic equipment, particularly that which uses an electron beam like X-ray tubes, image intensifiers and video display monitors, will have varying degrees of sensitivity to the magnetic field. The most extreme case is the X-ray image intensifier, where normal operation will only be obtained at values similar to the earth's magnetic field intensity.

Fringe fields

8.26 Fringe fields are dealt with by the combination of inherent design within the MRI itself, so called active shielding, and the use of one or another type of passive shielding. Active shielding involves the use of an electron magnet, which generates fields opposing the fringe field generated by the principal magnets. This has a cancelling effect and is often the cheapest and easiest way of constraining fringe fields. Passive shielding depends on introducing large masses and, in some cases, areas of steel or other ferromagnetic materials that in effect capture the magnetic field and concentrate it away from areas requiring protection. Thicknesses between 3 and 10 mm will be required and, where the areas to be protected are large, considerable weight and, thus, structural consequences may arise. However, for many modern MRI scanners, particularly those in operations at 1 T or below, the use of shielding is increasingly uncommon, since the inherent characteristics of the magnet are reasonably satisfactory with respect to fringe fields.

8.27 All current UK MRI manufacturers and suppliers should be able to provide idealised fringe maps that do not take into account any shielding or ferromagnetic structures inherent in the building structure.

Radio frequency radiation

8.28 A radio frequency cage, essentially a Faraday cage, will always be needed for MRI installation without exception. As mentioned previously, all mechanical and electrical services entering the MRI scanning room will generally be routed through specifically designed access

points so that the RF shielding of the room is not compromised. In some instances, the precise arrangement will be specific to the MRI system chosen or will be constrained by other elements of the project. For air-conditioning, some designs utilise air outlet grills above the perforated RF cage structure, so that the airflow, rather than the air-conditioning system, penetrates the cage.

8.29 It is recommended that all engineering services be grouped, as far as is practical, to facilitate penetration via a wave guide through the RF shielding cage. This will lead to the option of constructing a services cupboard, which will contain the wiring and pipe work incorporated to the RF access pad/wave guide. Such a structure will be duplicated on both sides of the RF cage itself. This arrangement is thought to favour efficiency in periodic maintenance and inspection of the services. In considering wave guides and ports within such pads, provision should be made to facilitate later expansion of the facility, in the form of a small number of extra access ports.

8.30 Broadly, within the MRI scanning room itself, all engineering services and components, including some sundry items such as supports, must be made of non-ferromagnetic material. Though there is an ability to tolerate small mass items, there can, nevertheless, become a difficulty during maintenance if they are dropped or dislodged. It is recommended that ductwork be constructed of aluminium or plastic materials and that pipe work be copper or plastic as appropriate. The RF cage itself will be constructed from aluminium or copper sheets supported by a frame.

8.31 Special problems arise with water leakage in MRI facilities. For this reason some scanning rooms, as distinct from suites, do not contain wash-hand basins and sinks. However, with the move toward interventional work being conducted in MRI facilities, the need for sinks and wash hand basins has risen considerably. Where they are installed, it is important that precautions, including secondary containment, are applied for pipe work and the installed facilities themselves. It is also important that inspection hatches are provided so that any parts of the plumbing installation can be readily accessed for maintenance. As high-powered devices are in use, good separation between water supply and electrical conductors is also necessary. Leakage can also be a hazard in terms of potential corrosion to the RF cage, something that must be expressly avoided.

8.32 In summary, an RF or Faraday cage, ordinarily constructed in aluminium or copper utilising sheet or gauze mesh, will be applied about the MRI scanning room itself. In some instances, particularly where there is equipment above, the cage may need to enclose both the ceiling and floor. Specialist advice from a RPA

qualified in magnetic resonance imaging should be sought in respect of each installation. This advisor will also be able to assist to some degree, in terms of safety and clinical effectiveness, with magnetic shielding and suite design.

Commissioning exercise

8.33 The commissioning of an MRI scanner in terms of an electrical test, approval of the building and its fittings, does not differ significantly from similar installations of specialist equipment. However, a number of special issues do arise:

- the monitoring of fringe field. This exercise, frequently conducted by either the manufacturer or by the RPA, involves the use of a hand held magnetometer to measure the field at the limit of the area in which access by persons can be controlled. This area, referred to as a controlled area, may exceed the 0.5mT limit described above. Outside this boundary the magnetic field must be constrained below this level. A strategy involving inner and outer controlled areas is common and the protection advisor will give a limitation for the outer area. A figure of 0.3mT is commonly used;
- in some instances, RF surveys are used to check the integrity of protective cages. This work must be done prior to the installation of the magnet itself, since the RF monitoring equipment and magnet are largely incompatible;
- special tests on the integrity of services and supplies as they pass through RF insulating pads and wave guides are needed.

8.34 Ordinarily, the EBME department of an NHS Trust or other suitable consulting engineers will deal with this, so as to ensure some independence from those actually carrying out the original work.

Decommissioning

8.35 The majority of issues are similar to those for the decommissioning of any major item of plant and machinery. As soon as the magnet is quenched, the magnetic hazard will be rapidly dissipated so that it will be possible to remove used equipment without fear from stray magnetic fields or other magnetic effects. Correct and orderly quenching prior to decommissioning is essential because of hazards from cryogenic gases themselves and from the very large current that flows within the super-conducting structure of the magnet.

8.36 The magnet coils contain specialised materials with significant re-cycling value. It is appropriate that a specialist contractor handle this issue, as it will have a particular bearing on cost and environmental protection. However, modern magnet designs can often permit the

use of a core magnet with two or even three evolutions of imaging systems that are re-built around it, at intervals of typically five to seven years.

SECTION 9 – SPECIALIST ENGINEERING REQUIREMENTS IN X-RAY FILM PROCESSING

Chemical mixers

9.1 A filtered and de-ionised water supply is needed for the chemical mixers associated with automatic film processors and wet laser imagers. The filtering equipment is usually provided and maintained by the processor supplier as part of the equipment purchase and is typically wall-mounted within the processing area or dark room adjacent to the mixer.

Processing area

9.2 Direct extract ventilation is required from each automatic film-processing unit, typically by 100 mm plastic extract ductwork. Equipment suppliers should be consulted regarding the requirements for electrical power supply to the processing units, the chemical mixers, and to silver recovery units. As an indication only, the automatic daylight processors are likely to require a 30A power supply. Other items of equipment are likely to require 13A power supplies.

9.3 In addition to direct extract ventilation from the processors, general room supply and extract ventilation will be required to provide between five and ten air changes per hour, depending on film throughput and room size. If a silver recovery unit is located in the processing room, consideration should be given in the detailed design of the ventilation system to possible accumulation of heavier than air gases e.g. the provision of low-level extract grills may be necessary.

9.4 General room lighting should allow for the use of wall-mounted X-ray viewing panels and of computer screens.

9.5 Drainage provision will be required to serve the automatic processing units. This will typically be 100 mm plastic drainage pipe set into the floor, possibly in access ducting. The fall of this drainage should be sufficient to prevent the accumulation of sediment to the drainage ducts. Where a processor is not installed against a wall, service channels will need to be provided in the floor construction for piped connections to the chemical mixer.

9.6 Risk factors associated with the disposal of chemical effluent and its affect on the environment can be calculated using appropriate mathematical models. This should be undertaken before the installation or increase of film processing equipment in the department. This calculation will determine limits for the disposal of chemicals to the sewer and will determine

which chemicals will require bulk storage and specialist disposal.

Silver recovery

9.7 At the time of writing, “screen” type double emulsion medical imaging films comprise the majority of imaging film used in the NHS. These emulsions can contain between 5 and 10 g per sq metre of recoverable metallic silver, depending on their manufacturer. Single emulsion film for mammography contains between 2 and 6 g per sq metre of recoverable metallic silver, depending on the manufacturer.

9.8 As digital radiography and other similar advancements and small-film usage techniques come into general use, the percentage use of “screen” film types will decrease.

9.9 Approximately one-third of this metallic silver stays in the emulsion after processing to form the diagnostic image. A small proportion of the residue stays in the developer and the remainder is removed by the fixing solution. Most of this silver is in solution or suspension in the fixing bath and can be recovered by electrolytic means as almost pure silver in recovery systems in the hospital or elsewhere.

9.10 The silver remaining as the film’s image can be recovered only when the film itself is removed from the archive store and sent to a commercial contractor with specialised recovery equipment.

9.11 It is essential to operate an efficiently managed silver recovery system. While silver recovery can provide a source of income to a hospital, the decreasing value and amount of silver used in current film emulsions, and the increasing cost of assay, commercial recovery and marketing of the metallic residues, can cause a reduction in this revenue. It is customary to use an external contractor under a lease agreement for most stages of silver recovery.

9.12 The most common method used for silver recovery is a high current density electrolytic method. Piped connections to the processors, together with local power supplies are necessary for the installation of the unit. It may be possible to recirculate fixer solution to the film processor, although manufacturers should be consulted.

9.13 In the interest of health and safety, silver recovery units should be located where staff will not be exposed to noxious fumes. Silver recovery units should not be sited in darkrooms. They may be sited in daylight film processing areas if the ventilation of these areas is provided in accordance with the guidance in this publication.

9.14 Where suitable commercial services are available, consideration should also be given to the collection and sale of used fixer solution in bulk when the storage of the used fixer solution may be located outside the department, thus eliminating any processing area leakage of fumes from this source. The re-use of fixer is, of course, not compatible with this procedure.

9.15 If the silver recovery process is to be undertaken locally at the NHS Trust, safe secure storage of the silver recovered should be undertaken with a darkroom or other secure area.

Disposal of chemically contaminated effluent

9.16 At an appropriate early stage in the design process, the drainage system designer should discuss and verify with the Environment Agency the project proposals for the collection and discharge of chemical contaminated effluents. The Environment Agency may impose restrictions on the quantity and rate of discharge of such effluents into public sewers.

9.17 It must be sealed throughout its run to the main sewer and its route should be chosen with regard to the areas likely to be affected if leaks develop. It is recommended that drainage for this purpose should not be into a pumped system.

Appendix 3 – Glossary of terms, abbreviations and further information on clinical techniques

GLOSSARY

A&E – Accident & Emergency

Actinic marking

The process of permanent identification of an X-ray film (with required details such as a patient's name, date of examination, etc.) by a photographic method using light or X-rays. The use of light is by far the more common method and various systems exist for marking a portion of the film either within the cassette or outside it.

Active magnetic shielding

An extra set of current-carrying coils built into the magnet. They surround the main magnet coils and create an opposing magnetic field, reducing the external stray (fringe) field significantly. All modern magnet designs incorporate the use of active magnetic shielding.

Anti-scatter grid

Each "grid" is made up of very thin, evenly spaced lead strips separated by strips of plastic or other radiolucent material, either parallel or focused for a particular exposure distance. Placed between the patient and the film or image intensifier, grids allow the primary beam to pass easily but markedly reduce the scattered radiation, to improve image quality. The "grids" may be incorporated in the apparatus (see bucky diaphragm) or they may be portable. The largest "grids" are typically about 43 cm square and weigh just over a kilogram.

ARSAC – Administration of Radioactive Substances Committee

Each radiologist practising radionuclide imaging must have an ARSAC certificate or licence, which clearly details the examinations that can be undertaken and the doses administered. The ARSAC committee issues the licences. Certificates must be updated on a five-yearly basis.

Aseptic room

A room with clean area designed constructed, serviced and used with the intention of preventing microbial contamination of the product.

Aseptic

This refers to procedures designed to exclude or minimise contamination.

BIR – The British Institute of Radiology

Information on the British Institute of Radiology can be found at <http://www.bir.org.uk>

BMUS – British Medical Ultrasound Society

Information on the BMUS can be found at <http://www.bmus.org.uk>

BNMS – British Nuclear Medicine Society

Information on the BNMS can be found at <http://www.bnms.org.uk>

Bucky (Potter Bucky) diaphragm

A device whereby an anti-scatter grid is caused to move or oscillate during the exposure. This allows the anti-scatter function to be performed without an image of the grid being visible on the film. The term is usually abbreviated to "bucky" and is used to refer not to the moving grid itself but to the assembly comprising a frame or holder containing the grid and having provision for the insertion of a cassette.

Cassettes

Lightproof containers in which X-ray films or Computed Radiography plates are placed prior to exposure. In Computed Radiography, the plates remain with the cassette after the data has been captured using the reader.

Chest stand

Apparatus, designed to hold cassettes in the vertical plane and normally floor-standing with either ceiling or wall support, used for taking chest X-rays. This device can also incorporate a bucky diaphragm or bucky as described above.

Cold heads

This is a term commonly used when referring to the refrigeration or cryogenic gas recovery system associated with MRI magnets.

Computed Radiography (CR)

A digital process for acquiring plain film general X-ray images similar in a number of respects to conventional acquisition techniques.

Computed Tomography (CT)

CT scanning is a form of cross-sectional imaging that combines X-ray images from a number of different projections to form a single or multiple images. Instead of using film to detect the x-ray beam, a bank of solid state detectors is used to acquire the data from the different projections.

Controlled area

See the Engineering Requirements appendix.

CoR – College of Radiographers

Further information on the College or Society of Radiographers can be found at <http://www.sor.org>.

Cross talk

In radionuclide imaging, where two gamma cameras are placed near each other, with little or no shielding between them, there is a risk that gamma rays from patients or sources used in QA procedures seen by one gamma camera may also be seen by the other close by. This can be minimised by careful orientation of the cameras relative to one another and by maximising the distance between them.

CRT or CRO – Cathode Ray Tube or Oscilloscope

A beam of electrons is focused onto a fluorescent screen to give a visible spot of light, within a vacuum tube. This is commonly used in computer monitors and similar devices.

Cryogenics

Super cooled liquid gases at temperatures at -200°C or lower, typically liquid helium and nitrogen, used to maintain the magnet coils at super-conducting temperatures.

CT scanning

These initials stand for Computed Tomography. This technique enables detailed examination to be made of body sections. The method uses a moving X-ray tube coupled to solid state or gas detectors, which measures the absorption values of the body section under examination. Images are generated, held and manipulated by computer techniques.

Dewar

A highly specialised-engineered vacuum walled vessel designed for holding cryogenic liquids at low temperatures just above absolute zero for transportation and delivery. These vessels can be large, up to 1.5 m in diameter, with associated attachments, and up to 2 m high. They are moved by the use of castors attached to their base.

Diagnostic index

An index of all examinations (or of selected examinations of interest) undertaken within a radiology department, filed according to the diagnosis. The filing may be according to the International Index of Diagnosis or to some simplified local format. The index may be kept on computer or on cards.

Digital Imaging and Communications in Medicine (DICOM) print protocol

The DICOM standard was developed jointly between the National Electrical Manufacturers Association (NEMA) and the American College of Radiology (ACR). The purpose of the standard is to allow images to be transferred and moved between a two modalities or computer workstations supplied by different vendors. DICOM provides a standard format for the transfer of images and all the original equipment manufacturers have signed up to this format to a greater or lesser degree. Laser printing is part of the DICOM standard data format, which allows images from a modality to be printed onto a laser printer from another manufacturer.

Digital subtraction angiography

By digitising X-ray images and using computer techniques to subtract one image from another, it is possible to enhance the demonstration of blood vessels by removing background shadows. The injection may be intra-arterial or intravenous. It usually requires complex apparatus and powerful computer processing facilities.

DR – Direct Radiography

This is a direct method for acquiring general radiographic images directly without an intermediate processing cycle such as that used in CR or conventional techniques. The processing electronics are stored directly in the bucky and the X-rays transmitted through the patient's body are converted directly to an X-ray image. For a fuller description, please see main text.

Eluate

In this case, the eluate is Technetium 99^{m} -pertechnetate and is captured by flushing the column of Molybdenum/Technetium 99^{m} in a radionuclide

generator with saline solution. The saline chemically bonds with the technetium to form Technetium 99^m-pertechnetate solution.

Examination table or couch

The name given to the “bed” on which many X-ray examinations are undertaken. They may be simple fixed tables, or have fixed feet but “floating” tops, which move freely in all horizontal axes. They may elevate, or tilt in one direction only. More sophisticated examples tilt up to 90° in both directions and have tops that have independent extensive movement both longitudinally and laterally.

Ferromagnetic substances

Substances with large positive magnetic susceptibility that become magnetised within a magnetic field and remain magnetised after being removed from the field. Cause large magnetic field distortions, signal loss and can become a projectile when near a magnet.

Filmless department or Picture Archive and Communication System (PACS)

A Diagnostic Imaging and Interventional Radiology department in which the majority of images and data are stored, accessed and manipulated in digital form, by the use of computer archives and sophisticated digital networks. Picture Archive and Communications Systems are required to store and communicate the images to different parts of the department. In order to achieve the greatest benefit, the network should be integrated with the Hospital Information or Patient Administration Systems and the Radiology Information System.

French

This term is often used to describe the internal diameter of catheters and needles used in some diagnostic imaging and interventional radiological procedures. One French is equivalent to approximately 1.4 mm.

Gadolinium-DTPA

Contrast media that is commonly used in a number of MRI investigations.

Gauss (G)

A unit of magnetic induction, where 1 gauss = 0.1 mT. The Earth's magnetic field strength is approximately 0.6 g.

High intensity film viewer

Also referred to as “bright-light”; this provides a localised source of high-level illumination. It can either be incorporated within a standard film viewer or be provided separately.

High voltage (HV) cables

High voltage (HV) cables convey the electrical energy from the transformer to the X-ray tube. Cables to the under-couch tube (where one is present) can be mainly carried in under-floor ducting. Those serving the over-couch tube are suspended from ceiling mountings.

Hospital Information System (HIS)

This is sometimes called Patient Administration System (PAS) and is used by the hospital or trust to store patient records and details.

ICRP – the International Commission of Radiation Protection

Information on the ICRP can be found at <http://www.icrp.org>

Intensifying screens

These are used singly or in pairs and consist of a fine layer of salts (usually “rare-earth”) mounted on a thin card or plastic base. These salts fluoresce when excited by irradiation. The screens are fitted inside a lightproof cassette. The X-ray film is placed between them and thus the effect of the radiation on the film is intensified, reducing the exposure required to achieve a diagnostic image.

Interventional radiology procedures

A general term used to describe procedures involving the insertion of needles, probes, catheters etc into patients with or without the injection of a contrast medium. The imaging modality is used to guide the procedure or placement of a catheter into the anatomy of the patient at the required position.

Intravenous urogram (IVU)

This is an examination of a patient's renal system and maybe used to look for kidney stones or as an adjunct to some radionuclide imaging studies. After a preliminary film has been taken, a contrast medium is injected (usually into the patient's arm) and this enables the kidneys, ureters and bladder to be visualised on X-ray films. The examination involves a series of films being taken by a radiographer at timed intervals. X-ray tomography is often involved in this procedure. The total examination normally takes about an hour but can vary considerably from patient to patient.

Ionising radiation

Ionising radiation is the part of the electromagnetic spectrum that is characterised by its property of ionising matter. Examples are X-rays, gamma rays, electrons and protons, all of which have applications in medicine.

IPEM – Institute of Physics and Engineers in Medicine

Information on the Institute of Physics and Engineers in Medicine together with a full listing of publications can be found at <http://www.ipem.org.uk>

Lead equivalent (LE)

The lead equivalent of a material is the thickness of lead that would absorb radiation to the same extent as the actual thickness of the material concerned, under specified conditions of irradiation. Lead equivalent is expressed in mm and is used as a measure of the protective properties of shielding materials.

Lead glass (protective glass)

Glass that contains a high proportion of lead compounds and thus has a relatively high absorption of X-rays (that is, a relatively high lead equivalent for a given thickness), although transparent to light. It is commonly used in the upper portion of radiation shields forming part of the control area of a general X-ray room.

Lead rubber

Rubber that contains a high proportion of lead compounds and is used as flexible protective material. This material is used to make gloves, jackets and coats, which are worn by persons otherwise unprotected from the scattered X-rays.

Lead rubber aprons and coats

Aprons to protect the wearer against scattered radiation. They are worn when the operator needs to be outside the control cubicle when an exposure is made.

Lead rubber gloves

Gloves, made from lead rubber, which protect the operator's hands from direct X-rays.

Lego-medical

Diagnostic imaging examinations can sometimes be used to resolve legal disputes, for example in personal injury claims.

Licensed

Possessing a licence from the licensing authority to operate as a manufacturer of pharmaceutical drugs. In addition, each individual drug used must be separately licensed. This has particular consequences in radionuclide imaging.

Light beam diaphragm

A device used to illuminate the desired area of the patient for accurate positioning prior to radiography.

It incorporates a centring illuminator and a set of lead "leaves", which ensure that during radiography the X-rays are confined to the illuminated area.

Magnetic resonance (MR)

The enhanced absorption of radio-frequency energy by nuclei or electrons in a static magnetic field when the energy is applied at the resonance frequency. In clinical applications, the term is assumed to represent interactions with nuclei. It is sometimes referred to as nuclear magnetic resonance (NMR). When applied to electrons, the method is called electron spin resonance (ESR) or electron paramagnetic resonance (EPR).

Magnetic resonance imaging (MRI)

Images of anatomical structures, which may be obtained by computing signals, obtained when a patient is placed in a strong magnetic field. The procedure is attractive for use in paediatrics because it involves the use of non-ionising radiation, rather than ionising radiation, thereby lowering the risks from the examination.

Magnetic shielding

Method for containing the stray (fringe) magnetic field produced by an MR system.

Mammography

Mammography is the radiographic examination of the breast. In a District General Hospital it commonly refers to procedures undertaken upon clinical request, as distinct from breast screening programmes. The imaging examination requires dedicated X-ray apparatus, film and processing equipment.

Master index

This is an index or database containing data referring to all patients examined within a diagnostic imaging and interventional radiology department. The data includes such details as the patient's name, address, age, sex and hospital number and may in some instances be combined with the report index. The index may be kept on computer or on cards. This is now undertaken on a computer by the use of a Radiology Information System.

Metastases

These are sometimes called secondaries and describe tumour spread to another part of the anatomy or body from the primary tumour. Secondaries or metastases are commonly located in bone or lymph nodes.

MOD – Magneto-optical Disk

There are two formats of MOD currently available, from two manufacturers. They are not interchangeable, that

is, a drive from one manufacturer is unable to read the disks supplied by the other.

Multi-film viewer

An apparatus comprising a number of movable, electrically or mechanically operated panels, which are capable of being placed in front of a fixed viewing box (commonly of light modules) so that multiple radiographs may be viewed sequentially.

National Cancer Registry

The National Cancer registry attempts to list all the patients suffering from cancer, year by year, together with the treatment regimes used and their overall success.

NOF – New Opportunities Fund

These are National Lottery funds that have been allocated for the capital procurement of new radiotherapy and radiology equipment for the NHS. The numbers and types of equipment to be procured have been identified in the National Plan for the NHS. The Department of Health Imaging Policy Group currently manages the fund. The first phase of equipment procurement is currently being undertaken.

NRPB – National Radiological Protection Board

Further information on the NRPB can be found at <http://www.nrpb.org.uk>.

Open Magnet Systems

These types of units provide far greater access to the patient during the examination or procedure than conventional cylindrical designs with a narrow patient bore. The main magnetic field is generated by two vertically opposing magnetic poles. Some manufacturers are now marketing new open systems, employing cryogenic as opposed to resistive current technology, which have larger main magnetic fields. The systems have real advantages in imaging paediatric and claustrophobic patients and when undertaking interventional MRI procedures, when compared with other designs of MRI systems.

PA – Posterior Anterior

This describes a projection used commonly for chest X-ray imaging. The X-ray beam enters the patient's back (posterior) and exits the front (anterior).

PACS – Picture Archive and Communication System

This is a digital method for storing and acquiring all the images generated in a diagnostic imaging and interventional radiology department and the associated network required to transmit these to different locations of a hospital and the department. The networking and data storage requirements are considerable and require large amounts of initial capital or revenue expenditure.

Passive magnetic shielding

Iron plates are applied directly to the magnet (self-shielding) or are placed in strategic locations on the walls of the magnet enclosure (room shielding). The plates of iron form an integral part of the magnetic circuit.

Permanent magnet

Magnet composed of large quantities of a permanent magnet material with high magnetic remanence and iron. It is used to produce field strengths typically less than 0.3 Tesla in whole body systems and higher field strengths in niche systems. Typically have a vertical static field orientation and minimal stray magnetic fields.

PET – Positron Emission Tomography

See main text for full description.

PFI and PPP – Private Finance Initiative and Public-Private Partnership

See main text.

Quality assurance phantoms

Test objects, which are used to evaluate the performance of diagnostic imaging equipment.

Quench

Sudden loss of superconductivity, typically causing rapid evaporation of cryogenes. May be spontaneous, due to inadequate levels of liquid helium or caused by small faults in the installation circuitry.

Radioactive isotope

A species of material that is radioactive and decays to a more stable state or to another radioactive isotope by the emission of a gamma ray, beta or alpha particle, for example. These isotopes are combined with chemicals to form radiopharmaceuticals.

Radio-frequency (RF) pulse

Oscillating magnetic field in the range 10–100 MHz, typically of relatively short duration, for example 1–10 msec, produced by an RF coil. In MR imaging, magnetic gradient fields, often pulsed, are applied in order to select individual slices of tissue.

Radio-frequency (RF) shielding

A shield to protect MR signals and the receiver coil in an MRI scanner from contamination by extraneous signals. The extraneous signals may be generated by a wide range of sources, including TV transmitters, commercial radio stations, two-way radios, paging systems and many types of electrical equipment, especially computers. Shielding also limits the transmission of the MR RF pulses into the environment.

Constructing an RF-shielded enclosure within the MRI scanner room often provides RF shielding. Various types of enclosure are available; including those made of copper or non-magnetic stainless steel.

Radiology Information and Management System (RIS & RMS)

This is a database that holds all the data on patients who have been examined together with the reports that have been dictated by the radiologists and subsequently reported by the supporting administrative staff. The Radiology Information System will usually be used to schedule patients for examinations following the receipt of requests. Clinicians working in the department will be able to access reports and data on patients using one of the many computer terminals located in the department. Where a hospital has procured a PACS it may be operationally advantageous if these databases are combined, to avoid patient identification problems. Where possible, Radiology Information Systems are interfaced with separate modalities to allow radiographers and other clinicians to call up patient's details and select them from a work-list on the modality workstation console.

Radiopharmaceuticals

Medicinal products which achieve their purpose by virtue of radioactivity and may be used for both therapy and diagnosis.

RCR – Royal College of Radiologists

Information on the Royal College of Radiologists and full list of publications can be found at <http://www.rcr.ac.uk>

Reflux

This is where fluid may flow back from one area of the body to another. The most common example is the flow of urine back to the kidney from the bladder during micturition.

Remote control fluoroscopic apparatus

This term applies to a type of fluoroscopic apparatus that can be completely operated by the radiologist from a remote console behind the protective screen. The equipment can be distinguished from conventional or

universal systems in that the image intensifier sits underneath the couch with the X-ray tube above.

Report index

An index containing details of the examination request and radiologist's report. It may, in some instances, be combined with the master index. The index may be kept on computer or on cards.

Resistive magnet

Magnet composed of current-carrying coils. It requires continuous input of electrical current and is used to produce the main magnetic field. These systems require continuous cooling by the use of chilled water supplies. This type of magnet design typically produces main field strengths of less than 0.4 Tesla. May have horizontal or vertical field orientation depending on magnet design. The design of the system may be particularly advantageous when undertaking interventional radiology procedures.

RPA – Radiation Protection Advisor

See main text.

RPS – Radiation Protection Supervisor

See main text.

RTP – Radiotherapy Treatment Planning

Radiotherapy treatments are planned before being undertaken and diagnostic images are used in the planning process.

Safe-lit area

A safe-lit area is one from which natural and artificial light can be excluded by use of light-proof doors or partitions. It has photographically "safe" lights installed for use when required. This enables the area to be used for handling photographically sensitive materials in safe conditions where necessary, for example during loading/unloading of film magazines.

Scatter (scattered radiation)

Ionising radiation that has been deflected from its original path and is a hazard both to film quality and to personnel.

Sharps

Needles or other sharp objects. They should be stored in a sharps bin following use.

Skull X-ray unit

A type of X-ray apparatus that has been designed specifically for examinations of the cranium, in particular the skull. It differs from general X-ray equipment in that

it provides much higher resolution images and a larger number of possible projections. The use of this equipment is in decline as Computed Tomography offers much better quality of diagnostic information, although at a slightly higher radiation dose. The number of radiographers skilled in using this equipment is also decreasing.

Stereotactic

Diagnostic imaging can demonstrate images in all three orthogonal planes to provide the approximate location or co-ordinates of pathology, which may be affecting physiological function or displacing other anatomy. The most common example would be the stereotactic location and biopsy of a primary tumour by the use of diagnostic images collected.

Superconducting magnet

Magnet consisting of superconducting windings contained within a sophisticated cryostat or Dewar operating at liquid helium temperatures. A power supply is connected to the superconducting windings initially to ramp up the magnetic field (up to 300A current) to achieve the final operating magnetic field. This electrical supply to the windings is then removed. Once the magnet is ramped up to full field the windings require no additional input of electrical current, except following a quench or controlled ramp down. Power is still required to the magnet system to operate the gradient coils and gas boil off recovery devices. This type of technology is typically used to produce field strength greater than 0.35 Tesla and up to 5.0T in specialist research applications. These magnets have, in general, a horizontal static field orientation, and stray magnetic fields may extend for large distances from the magnet unless magnetic shielding is used.

Supervised area

An area where the dose received is likely to be more than one-tenth but less than three-tenths of the annual dose limit for adult workers. Such areas are common. There is no restriction of access but work in the area should be subject to an "agreed" scheme of work.

Television video camera

Television video camera is used in conjunction with an image intensifier/amplifier to carry out fluoroscopy and may also be used to transmit images elsewhere.

Tesla (T)

Unit of magnetic induction equal to 10,000 gauss.

TFT – Thin film transistor

This is a transistor made up of extremely thin layers of metal or semiconductor material. The technology is

commonly used to manufacture display screens such as those used in laptop computers. The cost of this technology is decreasing rapidly and will probably gradually replace the use of standard cathode ray tube monitors for the display of radiological images in both real time, reporting and review applications.

Tissued

There is small risk that, during intravenous administrations of contrast media for example, the material may not end up in the blood circulation as intended by the clinician. In such instances, the substance may enter other tissues such as muscles etc and this is commonly referred to as tissue injection.

Trendelenburg

A term used to indicate the head-down or adverse tilt of an X-ray tilting table. Such tables normally move from a vertical position through the horizontal to a varying degree of adverse tilt. The range of movement of an individual table is often shown, for example as 90°/30°, which would indicate vertical position in one direction and an adverse tilt or trendelenburg of 30°.

Universal or conventional fluoroscopy equipment

This equipment is similar in design and space requirements to remote fluoroscopy equipment, but in this instance, the radiographer will operate the equipment from within the examination room.

VQ – Ventilation/Perfusion

A radionuclide imaging lung scan may commonly be referred to as a VQ scan.

Waveguides

In order to maintain the integrity of the radiofrequency shielding, mechanical services such as liquids, gases and electrical cables need to be passed into the scanner room through filtering devices known as waveguides, which are basically long pieces of hollow copper pipes. In the case of air conditioning systems, the waveguides are packed together to form a honeycomb and the ducting is connected either side of the honeycomb. In the case of liquids and gases, these need to be electrically isolated.

X-ray film viewing box

Also referred to as a film viewer box or illuminator. An opal glass-fronted box, evenly illuminated from the rear, on the face of which radiographs are clipped for viewing. Usually provided in multiples of 35 x 43 cm modules with switches and/or dimmers.

X-ray fluorography or Digital Spot Images (DSI)

Diagnostic images that are acquired permanently by the use of a combination of an image intensifier and TV camera and recorded digitally usually for reporting purposes and to demonstrate a normal or abnormal examination. The images are usually of higher quality than would be obtained in fluoroscopy and the imaging parameters are set-up to suit the imaging of an area of anatomy. The number of frames per second (fps) acquired will depend on the clinical application and machine and may be as high as 50 fps in paediatric cardiac applications. This technique uses much more energy instantaneously than fluoroscopy, up to 100 kW per pulse rated for 0.1 seconds.

X-ray fluoroscopy or screening

Continuous images of physiological motion or anatomy acquired using an image intensifier and a television camera. The images are displayed on monitors in the exam area and are used to position the equipment, direct a procedure or catheter into position, for example. The images may be recorded onto videotape or digitally and stored using the imaging computer. The latter option only exists in new equipment. Digital image acquisition allows the operator to select the level of temporal resolution required for the procedure, for example between 3 and 25 frames per second. The electrical energy required to maintain fluoroscopic operation is between 1 and 2 kW. The technique is sometimes called screening but should not be confused with clinical screening that is used in mammography, for example.

X-ray generation and detection

X-rays are generated in an X-ray tube by accelerating a focused beam of electrons emitted from a heated filament (the cathode) to impinge at high velocity on a target (the anode). The accelerating voltage between anode and cathode, which varies according to the techniques in use, is normally between 25 and 150 kV. The X-rays are emitted from the small area of the target (the focal spot), which is bombarded by the electron beam. These rays have a high penetrating power and can pass through many substances including body tissues.

In their passage through the body, X-rays are partially attenuated, the extent depending on the nature and thickness of the tissues in the path of the beam. By placing a sensitive film (or other detecting device, as in CT scanning) in the path of the emergent beam, an image is formed of the body tissues in terms of their differing abilities to absorb the X-rays.

The rays, which produce the film image, emerge from the X-ray tube through a beam-limiting device and are

known as the useful beam. Additional radiation can also be present in the form of:

- leakage from the X-ray tube housing;
- scattered radiation, which is radiation generated by the interaction between the useful beam and objects in its path (including the patient) and is emitted in directions other than that of the useful beam;
- residual radiation which, having passed through both patient and cassette, emerges in the direction of the useful beam.

Suitable measures must be taken in the building construction and in the installation, siting, and use of X-ray equipment to ensure protection of all persons from unnecessary exposure to these forms of radiation.

The films used in radiography differ from those for most photographic processes in that they consist of a base coated on both sides with emulsion sensitive to light and to X-rays. When the X-rays irradiate a suitable material (usually rare earth phosphors) it fluoresces, and, to enhance or "intensify" the effect of the radiation, the sheet of X-ray film is held in close contact between two fluorescent surfaces known as intensifying screens. The emulsion is thus subjected to the influence of both light and X-rays. These intensifying screens are held with the film in a lightproof container known as a cassette; the largest in general use (holding films of 35 cm x 43 cm size) may at present weigh up to approximately 2.8 kg.

X-ray Tomography

A radiographic technique designed to form a diagnostic image of a selected plane within the body. In conventional tomography (as opposed to CT scanning) the method used is to move the X-ray tube and the film in opposite directions during the exposure in such a manner that the desired plane is imaged sharply, but other planes are blurred. The movement is commonly linear, but more complex movements in two dimensions may be employed.

ABBREVIATIONS

ADB – Activity DataBase

AEC – automatic exposure control

AGSS – automatic gas scavenging system

CCTV – closed-circuit television

CDC – controlled drugs cupboard

CPD – continuous professional development

CT – computed tomography

CVI – cerebrovascular incident

CXR – chest X-ray

DDA – Disability Discrimination Act

DGH – District General Hospital

DSI – digital spot imaging

DVD – digital versatile disk

ECG – echo-cardiogram

EPR – electronic patient record

ERCP – endoscopic retrograde cholangiopancreatography

FDG – 2-(Fluorine 18) Fluoro-2-Deoxy-0-Glucose

GA – general anaesthetic

GI tract – gastrointestinal tract

GP – general practitioner

HDU – high dependency unit

HSG – histerosalpingography

ID – identification

IEE Standards – International Electrical & Engineering Standards

II – image intensifier

IMRT – intensity modulated radiotherapy

IRR – Ionising Radiations Regulations

ITU – intensive therapy unit

IV – intravenous

LAN – local area network

MDA – Medical Devices Agency

MRA – magnetic resonance angiography

MRC – magnetic resonance console

MRCP – magnetic resonance retrograde cholangiopancreatography

MRI – magnetic resonance imaging

PTCA – percutaneous transluminal coronary angioplasty

PTV – planning target volume

QA and Q/A – quality assurance

RF – radio frequency

SSD/U – sterile services department or unit

TLD – thermo-luminescent dosimetry

TOF – time of flight

WAN – wide area network

BASIC DESCRIPTIONS OF INTERVENTIONAL RADIOLOGICAL PROCEDURES UNDERTAKEN USING X-RAY IMAGING GUIDANCE

Vascular imaging

Venography

X-ray fluoroscopy in combination with the use of contrast media may be used as a means of imaging the lower peripheral veins in the assessment of occlusions and stenoses and reduced blood flow. This procedure has been replaced in the majority of institutions by the use of ultrasound imaging.

Fistulogram

Fistulas are simply malformations of the arteries and other blood vessels. X-ray fluoroscopy may be used to provide information on vascular fistulas for further interventional or surgical procedures.

Vascular Intervention

PTA – Percutaneous Transluminal Angioplasty or balloon catheter angioplasty

Percutaneous Transluminal Angioplasty may be used to restore blood flow when the artery has become occluded or stenosed with plaques, scar tissue or other fatty deposits. The flexible catheter is fitted with a small balloon and then moved to site of the diseased vessel under fluoroscopic control. The balloon is then inflated, which disturbs any deposits etc and expands the lumen of the blood vessel. In the majority of cases, this re-establishes the patency of blood flow through the vessel or artery. It should be noted that this procedure may not provide a permanent solution and use of stents may be required to prevent reoccurrence of the problem.

Stent placement

Stents are primarily hollow metal or plastic structures that are used to maintain or induce lumen patency. In respect of vascular interventional procedures stents may be used subsequently or instead of balloon catheter angioplasty, as a means of restoring blood flow or restoring arterial or vessel patency. As described for ureteric stenting, one of the largest post procedure complications is the presence of infection, which in some cases may be treated by antibiotics.

TIPS – Transjugular intrahepatic portosystemic shunt

This procedure is performed under imaging control as a means of managing portal hypertension (high venous

blood pressure from the liver). Portal hypertension can lead to gastrointestinal haemorrhage (bleeding) and ascites (a collection of large amounts of fluids in the abdomen or peritoneal cavity). This procedure has displaced some of the surgical work undertaken in this area. Patients are always treated on an in-patient basis due to the relatively invasive nature of the technique.

Cardiac pacemaker insertion

Pacemakers are devices used to produce and maintain a normal heart rate in patients who have a heart blockage or other heart problems. The unit consists of a battery that stimulates the heart through an insulated electrode wire attached to the surface of the ventricle (epicardial pacemakers) or lying in contact with the lining of the heart (endocardial pacemakers). Temporary pacemakers have an external battery and stimulate the heart at a fixed rate demand pacemakers are permanently implanted under the skin and sense when the natural heart rate falls below a predetermined value and then stimulate the heart. The procedure can be undertaken in an interventional suite as described in this section or in a dedicated cardiac angiography and interventional suite.

Non-vascular intervention

Percutaneous nephrostomy

This method has displaced surgical nephrostomy as the first line method for renal drainage and accessing the collecting system of the kidneys. Indications for percutaneous nephrostomy include obstruction, kidney stone removal, perform a functional assessment of the kidneys and treat infection. In this procedure, a combination of ultrasound and C-arm fluoroscopy currently provides the most suitable of imaging modalities. During the procedure, the radiologist may need to have good access to the C-arm and table movement controls, so the design of the facility should facilitate this operational requirement. There are some instances where this procedure may be undertaken in an emergency situation.

Ureteric stenting

Ureteric stenting is used as a means of re-establishing patency of one or more of the ureters leading from the kidneys to the bladder. In some cases, the tumours, stones or other types of strictures may block the ureters. There are two approaches, either antegrade (percutaneous) or retrograde (transurethral). The largest complication of stent placement is encrustation. This means that replacement may be required every six months. Replacements can be undertaken on outpatient basis using a C-arm fluoroscopy device in combination with endoscopy, with the patient under light sedation. In the first instance, however, patients may be seen on in-

patient basis. Another observed complication is the presence of infection following stent placement.

The built environment for interventional suites should therefore support procedures that minimise the risk of infection and also allow for all the additional equipment connected with endoscopy to be located in the examination room. Care of the patient before the procedure also needs to be considered.

Biliary interventional work (drainage, stents, stones etc)

Further information in this regard will appear in future updates of the guidance.

Transjugular liver biopsy

Biopsy of liver tumours may be undertaken under fluoroscopic control where there is a need for great accuracy to avoid piercing a nearby artery or vein or where ultrasound liver biopsy (see below) procedures have proved unsuccessful.

Hickman/Tessio line insertion

In some cases it may be necessary to deliver chemotherapy drugs straight into the systemic to avoid them being directly absorbed by other sensitive organs. This can be achieved placing a temporary catheter in one of the arteries in the chest and ensuring that one end can be easily accessed without percutaneous intervention. This is known as a hickman line. In order to avoid complications, the catheter may be placed into position by the use of X-ray fluoroscopy.

Ultrasound examinations and procedures

Abdominal work example – ultrasound guided percutaneous liver biopsy

Ultrasound guided percutaneous liver biopsy can be used to guide a non focal right lobe liver biopsy or to image, in real time, needle sampling of a focal lesion. The use of ultrasound guided techniques has many advantages over blind techniques, such as lower complication rates and the benefit to patients with abnormal coagulation physiology. Patients can be seen on a “day case” basis, but should be kept under observation for at least six hours following the procedure. However, patients will need to be pre-selected for day case procedures, with those not meeting the criteria being seen as in-patients.

Acute appendicitis

Ultrasound imaging can be used in the assessment of acute appendicitis, in particularly estimating the size and position of an enlarged appendix, thereby providing further information to the surgical team.

Vascular and cardiac imaging

Ultrasound imaging is used extensively in cardiac and vascular imaging and has replaced some techniques using ionising radiation, particularly where imaging of young children and neonates is necessary. Ultrasound imaging may be used within specialist but separate facilities diagnosing both vascular and cardiac disease. The facilities associated with the use of ultrasound in cardiology are described in the NHS Estates guidance 'Facilities for cardiac services'. Further information on the use of ultrasound in vascular diseases and the associated built environment implications will be included in future updates of this guidance.

Use in combination with other modalities and techniques – deep vein thrombosis (DVT)

It is common to use to ultrasound imaging as a method of complementing other diagnostic imaging investigations. For example, some cases of pulmonary embolism can be difficult to diagnose using the radionuclide and chest X-ray examinations described in the main text. An ultrasound examination may be used in conjunction with these diagnostic tests, to look for blood clotting in the peripheral veins of the leg otherwise known as DVT and has been clinically linked with existence of pulmonary emboli. The use of ultrasound may provide greater certainty in the overall diagnosis and ensure that the patient is assigned the correct treatment pathway. In this instance, the ultrasound examination would be undertaken almost immediately following the radionuclide examination.

Obstetrics

Ultrasound imaging is commonly used in assessing the development of a foetus from a very early age up to when the child is about to be delivered. In this case, ultrasound imaging can be used to assess the growth of the foetus and in some cases guide amniotic procedures. In some instances, there may be a requirement for the foetus to be scanned while the patient has a full and empty bladder. Therefore the provision of a toilet adjacent to the examination room is seen as important. In some cases, it may be necessary to inform the patient on highly confidential and sensitive issues on the development of their child and thus counselling and quiet rooms should be provided within the suite.

Gynaecology

The availability of ultrasound imaging contrast media has seen the introduction of a number of new techniques. Of particular interest is the use of ultrasound to evaluate fallopian tube patency. In a number of respects, this is similar to HSG procedures described in the main text. The interest has stemmed from the need to move away

from a technique that uses ionising radiation. However a recent study has shown that the technique is not as accurate as the fluoroscopy examination and can lead to complications and pain following the procedure. In most cases, patients will need to be kept under clinical observation for at least one to two hours following the procedure.

Prostate and testicular scanning

Ultrasound is one of the main imaging modalities used to detect prostate or testicular cancer. In some cases, images acquired from ultrasound imaging may be used to inform the cancer treatment planning process.

Interventional techniques including intra-luminal ultrasound

This is a relatively new technique, where ultrasound is used to guide catheters in arteries, veins and other hollow structures such as the oesophagus, and is currently under evaluation. Further information on this procedure will be included on future updates of this publication.

Lymph node imaging in support of cancer

It is common for lymph nodes to become involved in some types of tumours when cancer cells spread from the primary site via the systemic circulation. Cancer tissue becomes embedded and starts growing within the lymph nodes. Ultrasound imaging can be used to assess the size of the lymph nodes and therefore provide information on tumour growth in these glands. In some instances, the ultrasound imaging may be used to support a lymph node biopsy.

Ultrasound mammography

Ultrasound imaging is commonly used in the assessment of suspicious findings following a mammography examination, either after a screening examination or as part of a triple stage assessment. In some instances, ultrasound may be used to guide the interventional biopsy work. Where ultrasound is used as part of a triple stage assessment, ultrasound facilities may be located outside the main department and near dedicated X-ray mammography suites, as part of a breast care unit.

Ophthalmology

High-frequency ultrasound procedures can be used in the diagnosis of pathologies connected with the eye including some connected with the optic nerve. This has, to some degree, replaced X-ray fluoroscopy investigations, which run the inherent risk of causing cataracts.

Tumour imaging in general

Ultrasound plays a general role in the diagnosis and treatment of cancer, in addition to the role identified in assessing the involvement of lymph nodes as secondaries or metastases. Ultrasound can be used to assess the sizes of primary and secondary tumours, provide information to the initial stages of treatment planning and provide follow-up once treatment has commenced.

Musculoskeletal ultrasound

This clinical application still remains limited in many radiology departments. However, high-resolution ultrasound is a versatile quick and dynamic procedure, which accurately depicts even the smallest structures. The use of this technique may have most use in evaluating pathologies in the extremities, in particular in children and examination of superficial structures such as the knee and ankle.

Appendix 4 – References

LEGISLATION

Consumer Protection Act 1987. The Stationery Office, 1987.

Disability Discrimination Act 1995. The Stationery Office, 1995.
(http://www.legislation.hmso.gov.uk/acts/acts1995/Ukpga_19950050_en_1.htm)

Health and Safety at Work etc. Act, 1974. The Stationery Office, 1974.

Radioactive Substances Act 1993. The Stationery Office, 1993.
(http://www.legislation.hmso.gov.uk/acts/acts1993/Ukpga_19930012_en_1.htm)

SI 1996: 2092 The Carriage of Dangerous Goods (Classification, Packaging and Labelling) and Use of Transportable Pressure Receptacles Regulations. The Stationery Office, 1996.
(http://www.legislation.hmso.gov.uk/si/si1996/Uksi_19962092_en_1.htm)

SI 1994: 3140 The Construction (Design and Management) Regulations. The Stationery Office, 1994.
(http://www.legislation.hmso.gov.uk/si/si1994/Uksi_19943140_en_1.htm)

SI 2380: 2000 The Construction (Design and Management) (Amendment) Regulations. The Stationery Office, 2000.
(<http://www.legislation.hmso.gov.uk/si/si2000/20002380.htm>)

SI 1999: 437 The Control of Substances Hazardous to Health Regulations (COSHH). The Stationery Office, 1999.
(<http://www.hmso.gov.uk/si/si1999/19990437.htm>)

SI 1992: 2372 The Electromagnetic Compatibility Regulations. The Stationery Office, 1992
(http://www.hmso.gov.uk/si/si1992/Uksi_19922372_en_1.htm#tcon)

SI 1992: 2792 Health and Safety (Display Screen Equipment) Regulations. The Stationery Office, 1992.
(http://www.legislation.hmso.gov.uk/si/si1992/Uksi_19922792_en_1.htm)

SI 1999: 3232 The Ionising Radiations Regulations. The Stationery Office, 1999.
(<http://www.legislation.hmso.gov.uk/si/si1999/19993232.htm>)

SI 1333: 1985 The Ionising Radiations Regulations. The Stationery Office, 1985.

SI 2000: 1059 The Ionising Radiation (Medical Exposure) Regulations. The Stationery Office, 2000.
(<http://www.legislation.hmso.gov.uk/si/si2000/20001059.htm>)

SI 1988: 778 Ionising Radiation (Protection of Persons Undergoing Medical Examination or Treatment) Regulations. The Stationery Office, 1988.
(http://www.legislation.hmso.gov.uk/si/si1988/Uksi_19880778_en_1.htm)

SI 1999: 3242 The Management of Health and Safety at Work Regulations. The Stationery Office, 1999.
(<http://www.legislation.hmso.gov.uk/si/si1999/19993242.htm>)

SI 1998: 2306 The Provision and Use of Work Equipment Regulations. The Stationery Office, 1998.
(<http://www.hmso.gov.uk/si/si1998/19982306.htm>)

SI 1996: 1350 The Radioactive Material (Road Transport) (Great Britain) Regulations. The Stationery Office, 1996.
(http://www.hmso.gov.uk/si/si1996/Uksi_19961350_en_1.htm#tcon)

SI 1992: The Workplace (Health, Safety and Welfare) Regulations. The Stationery Office, 1992.
(http://www.hmso.gov.uk/si/si1992/Uksi_19923004_en_1.htm#tcon)

Council Directive 96/29/Euratom of 13 May 1996 laying down basic safety standards for the protection of the health of workers and the general public against the dangers arising from ionizing radiation. *Official journal NO. L 159 , 29/06/1996 P. 0001 - 0114*
(http://europa.eu.int/eur-lex/en/lif/dat/1996/en_396L0029.html)

Council Directive 97/43/Euratom of 30 June 1997 on health protection of individuals against the dangers of ionizing radiation in relation to medical exposure, and repealing Directive 84/466/Euratom. *Official journal NO. L 180, 09/07/1997 P. 0022 - 0027* (http://europa.eu.int/eur-lex/en/lif/dat/1997/en_397L0043.html)

NHS ESTATES PUBLICATIONS

Fire risk assessment in Nucleus hospitals (Firecode). NHS Estates, The Stationery Office, 1997.

Magnetic resonance imaging (Health Guidance Note). NHS Estates, The Stationery Office, 1997.

Policy and principles (Firecode). NHS Estates, The Stationery Office, 1994.

"Safe" hot water and surface temperatures (Health Guidance Note). The Stationery Office, 1998.

Strategic guide to combined heat and power. NHS Estates, The Stationery Office, 1993.

Briefing and design guidance

Facilities for cancer care centres. NHS Estates, The Stationery Office, 2001.

Facilities for cardiac services. NHS Estates, The Stationery Office, 2001.

Facilities for mortuary and post-mortem room services. NHS Estates, The Stationery Office, 2001.

Health and safety and the environment

Infection control in the built environment. NHS Estates, The Stationery Office, 2001.

Health Building Notes

HBN 6 Radiology department. NHS Estates, The Stationery Office, 1993.

Supplement 1 Accommodation for magnetic resonance imaging. NHS Estates, The Stationery Office, 1994.

HBN 22 Accident and emergency department in an acute general hospital. NHS Estates, The Stationery Office, 1995.

HBN 26 Operating department. NHS Estates, The Stationery Office, 1991. (under review)

HBN 29 Accommodation for pharmaceutical services. NHS Estates, The Stationery Office, 1997.

HBN 40 Common activity spaces

Vol 1: Public areas. NHS Estates, The Stationery Office, 1995.

Vol 2: Treatment areas. NHS Estates, The Stationery Office, 1995.

Vol 3: Staff areas. NHS Estates, The Stationery Office, 1995.

Vol 4: Circulation areas. NHS Estates, The Stationery Office, 1995.

HBN 48 Telephone services. NHS Estates, The Stationery Office, 1997.

Health Technical Memoranda

HTM 57 Internal glazing. NHS Estates, The Stationery Office, 1995.

HTM 58 Internal doorsets. NHS Estates, The Stationery Office, 1998.

HTM 59 Ironmongery. NHS Estates, The Stationery Office, 1998.

HTM 60 Ceilings. NHS Estates, The Stationery Office, 1989.

HTM 63 Fitted storage systems. NHS Estates, The Stationery Office, 1989.

HTM 81 Fire precautions in new hospitals. NHS Estates, The Stationery Office, 1996. (<http://www.nhsestates.gov.uk/knowledge/guidance.html>)

HTM 82 Alarm and detection systems. NHS Estates, The Stationery Office, 1996. (<http://www.nhsestates.gov.uk/knowledge/guidance.html>)

HTM 83 Fire safety in healthcare premises – general fire precautions. NHS Estates, The Stationery Office, 1994. (<http://www.nhsestates.gov.uk/knowledge/guidance.html>)

HTN 85 Fire precautions in existing hospitals. NHS Estates, The Stationery Office, 1994.

HTM 86 Fire risk assessment in hospitals. NHS Estates, The Stationery Office, 1994.

HTM 87 Textiles and furniture. NHS Estates, The Stationery Office, 1999.

HTM 88 Fire safety in health care premises – guide to fire precautions in NHS housing in the community for mentally handicapped (or mentally ill) people. NHS Estates, The Stationery Office, 1986.

- HTM 2005 Building management systems
 Management policy. NHS Estates, The Stationery Office, 1996
 Design considerations. NHS Estates, The Stationery Office, 1996
 Validation and verification. NHS Estates, The Stationery Office, 1996
 Operational management. NHS Estates, The Stationery Office, 1996.
- HTM 2007 Electrical services supply and distribution
 Management policy. NHS Estates, The Stationery Office, 1993.
 Design considerations. NHS Estates, The Stationery Office, 1993.
 Validation and verification. NHS Estates, The Stationery Office, 1993.
 Operational management. NHS Estates, The Stationery Office, 1993.
- HTM 2011 Emergency electrical services
 Management policy. NHS Estates, The Stationery Office, 1993.
 Design considerations. NHS Estates, The Stationery Office, 1993.
 Validation and verification. NHS Estates, The Stationery Office, 1993.
 Operational management. NHS Estates, The Stationery Office, 1993.
- HTM 2014 Abatement of electrical interference
 Management policy. NHS Estates, The Stationery Office, 1993.
 Design considerations. NHS Estates, The Stationery Office, 1993.
 Validation and verification. NHS Estates, The Stationery Office, 1993.
 Operational management. NHS Estates, The Stationery Office, 1993.
- HTM 2015 Bedhead services
 Management policy. NHS Estates, The Stationery Office, 1994.
 Design considerations. NHS Estates, The Stationery Office, 1995.
 Validation and verification/Operational management. NHS Estates, The Stationery Office, 1995.
- HTM 2022 Medical gas pipeline systems
 Design, installation, validation and verification. NHS Estates, The Stationery Office, 1997.
 Operational management. NHS Estates, The Stationery Office, 1997.
- HTM 2023 Access and accommodation for engineering services
 Management policy. NHS Estates, The Stationery Office, 1995.
 Good practice guide. NHS Estates, The Stationery Office, 1995.
- HTM 2025 Ventilation in healthcare premises - a code of practice.
 Management policy. NHS Estates, The Stationery Office, 1994.
 Design considerations. NHS Estates, The Stationery Office, 1994.
 Validation and verification. NHS Estates, The Stationery Office, 1994.
 Operational management. NHS Estates, The Stationery Office, 1994.
- HTM 2027 Hot and cold water supply, storage and mains services
 Management policy. NHS Estates, The Stationery Office, 1995.
 Design considerations. NHS Estates, The Stationery Office, 1995.
 Validation and verification. NHS Estates, The Stationery Office, 1995.
 Operational management. NHS Estates, The Stationery Office, 1995.
- HTM 2045 Acoustics
 Management policy. NHS Estates, The Stationery Office, 1996.
 Design considerations. NHS Estates, The Stationery Office, 1996.
 Validation and verification/Operational management. NHS Estates, The Stationery Office, 1996.
 Audiology. NHS Estates, The Stationery Office, 1996.
- HTM 2055 Telecommunications (telephone exchanges)
 Management policy. NHS Estates, The Stationery Office, 1994.
 Design considerations. NHS Estates, The Stationery Office, 1994.
 Validation and verification. NHS Estates, The Stationery Office, 1994.
 Operational management. NHS Estates, The Stationery Office, 1994.

DEPARTMENT OF HEALTH PUBLICATIONS

Capital Investment Manual

- Overview. NHS Executive, The Stationery Office, 1994.
- Project organisation. NHS Executive, The Stationery Office, 1994.
- Private finance guide. NHS Executive, The Stationery Office, 1994.
- Business case guide. NHS Executive, The Stationery Office, 1994.
- Management of construction projects. NHS Executive. NHS Estates, The Stationery Office, 1994.
- Commissioning a health care facility. NHS Executive, The Stationery Office, 1994.
- IM&T guidance. NHS Executive, The Stationery Office, 1994.
- Post-project evaluation. NHS Executive, The Stationery Office, 1994.

Guidance on the application of the minimum ergonomic working standards for personnel engaged in the preparation, scanning and reporting of cervical screening slides (Addendum to MDA/97/31) Sep-97 MDA/97/31S NCSP. Medical Devices Agency, 1997.

Guidelines for magnetic resonance diagnostic equipment in clinical use with particular reference to safety. Medical Devices Agency, Department of Health, 1993.

Health building and estate management : building legislation compliance procedures (HC(88)60). Department of Health, 1988.

Mobile phones and health. Independent Expert Group on Mobile Phones, Department of Health, 2000. (<http://www.iegmp.org.uk>)

National service framework for coronary heart disease: modern standards and service models. Department of Health, 2000. (www.doh.gov.uk/nsf/coronary.htm)

The New NHS: modern, dependable. Department of Health, The Stationery Office, 1997. (<http://www.official-documents.co.uk/document/doh/newnhs/newnhs.htm>)

The NHS Plan. Department of Health, The Stationery Office, 2000. (<http://www.doh.gov.uk/nhsplan/default.htm>)

A Policy framework for commissioning cancer services : A report by the Expert Advisory Group on Cancer (Calman-Hine Report). Department of Health, 1995. (<http://www.doh.gov.uk/cancer/pdfs/calman-hine.pdf>)

Radiodiagnostic department (Health Equipment Note 6). Department of Health and Social Security, 1982. (out of print)

Technical requirements for the supply and installation of equipment for diagnostic imaging and radiotherapy (TRS 89). Medical Devices Agency, Department of Health, 1989.

OTHER PUBLICATIONS

Air distribution systems (Commissioning code A). The Chartered Institution of Building Services Engineers (CIBSE), 1996.

BS 2881: 1989 Specification for cupboards for the storage of medicines in health care premises. British Standards Institute, 1989. (Confirmed 1994)

BS 4533 Luminaires. British Standards Institution. (produced in various sections)

BS 4533-102.55: 1986 Luminaires. Particular requirements. Specification for luminaires for hospitals and health care buildings. **Partially replaced by BS EN 60598-2-25:1995 Luminaires. Particular requirements. Luminaires for use in clinical areas of hospitals and health care buildings.** British Standards Institute, 1986/95.

BS 4533-103.2: 1986 Luminaires. Performance requirements. Specification for photometric characteristics of luminaires for hospitals and health care buildings. British Standards Institute, 1986.

BS 5266: 1999 Emergency lighting. Code of practice for the emergency lighting of premises other than cinemas and certain other specified premises used for entertainment. British Standards Institute, 1999.

BS 5295-2: 1989 Environmental cleanliness in enclosed spaces. Method for specifying the design, construction and commissioning of clean rooms and clean air devices. British Standards Institution, 1989.

BS 6651: 1999 Code of practice for protection of structures against lightning. British Standards Institution, 1999.

BS 7671: 1992 Requirements for electrical installations. IEE Wiring Regulations. 16th Edition. **With amendments: AMD 10983 published 15 April 2000; AMD 8536 published 15 January 1995; AMD 9781 published 01 December 1997; Amendment No 2 version may not be used for design purposes after 31 December 2001.** British Standards Institution, 1992.

BS EN 740: 1999 Anaesthetic workstations and their modules. Particular requirements. British Standards Institution, 1999.

BS EN 12056-2: 2000 Gravity drainage systems inside buildings. Sanitary pipework, layout and calculation. British Standards Institution, 2000.

- BS EN 55015: 2001 Limits and methods of measurement of radio disturbance characteristics of electrical lighting and similar equipment. British Standards Institution, 2001.
- BS EN 60601-1-2: 1993 Medical electrical equipment. General requirements for safety. Collateral standard. Electromagnetic compatibility. Requirements and tests. British Standards Institution, 1993.
- Guidance note 7: special locations. Institution of Electrical Engineers, 1998.
- Guidance to engineering commissioning. Institute of Healthcare Engineering and Estate Management, 1995.
- Justification in radiation protection. British Institute of Radiology, 1998. (www.bir.org.uk)
- Lighting guide: Hospital and health care buildings (LG2). Chartered Institution of Building Services Engineers (CIBSE), 1989. (under review)
- Making the best use of a department of clinical radiology. Guidelines for doctors. Fourth edition. Royal College of Radiology, 1998. (www.rcr.ac.uk)
- Metastases from non-small cell lung cancer : mediastinal staging in 1990s - meta analytic comparison of PET with CT. *Radiology*, 1999, volume 213, pp 530–536.
- Notes on building materials and references on shielding data for use below 300kVp (Report 41). Institute of Physics and Engineering in Medicine, 1984 (reprint) (www.ipem.org.uk)
- Occupational exposure limits (EH40). Health and Safety Executive, HSE Books, issued annually.
- Public health engineering (CIBSE Guide G). The Chartered Institution of Building Services Engineers (CIBSE), 1999.
- Radiation shielding for diagnostic X-rays. British Institute of Radiology, 2000.
- Retention of X-ray films résumé of the issues. Royal College of Radiology, 1991. (www.rcr.ac.uk)
- The visual environment for display screen use (LG3). The Chartered Institution of Building Services Engineers (CIBSE), 1996.
- Water distribution systems (Commissioning code W). The Chartered Institution of Building Services Engineers (CIBSE), 1994.
- Work with ionising radiation: Ionising Radiations Regulations 1999: approved code of practice and guidance. Health and Safety Commission, HSE Books, 2000.

About NHS Estates guidance and publications

The Agency has a dynamic fund of knowledge which it has acquired over 40 years of working in the field. Our unique access to estates and facilities data, policy and information is shared in guidance delivered in four principal areas:

Design & Briefing

These documents look at the issues involved in planning, briefing and designing facilities that reflect the latest developments and policy around service delivery. They provide current thinking on the best use of space, design and functionality for specific clinical services or non-clinical activity areas. They may contain schedules of accommodation. Guidance published previously under the headings Health Building Notes (HBNs), Design Guides and design-related Health Facilities Notes (HFNs) are found in this category.

Examples include:

Facilities for cancer care centres
Facilities for cardiac services
Diagnostic and Treatment Centres: ACAD, Central Middlesex Hospital – an evaluation
Maternity department
Infection control in the built environment: design and planning

Operational (Engineering, Facilities Management, Fire, Health & Safety and Environment)

These documents provide guidance on the design, installation and running of specialised building service systems and also policy guidance and instruction on Fire, Health & Safety and Environment issues. Health Technical Memoranda (HTMs) and Health Guidance Notes (HGNs) are included in this category.

Examples include:

Electrical services supply and distribution
Sterilization: operational management with testing and validation protocols
The control of legionellae in healthcare premises – a code of practice
Fire safety – alarm and detection systems

Strategic

These are documents which deal with areas of broad strategic concern and planning issues, including capital and procurement.

Examples of titles published under this heading are:

Estatecode
How to Cost a Hospital
Capital Investment Manual
Developing an Estates Strategy
Sustainable Development

NHS Estates Policy Initiatives

In response to some of the key tasks of the NHS Plan and the Modernisation Agenda, NHS Estates has implemented, project-managed and monitored several programmes for reform to improve the overall patient experience. These publications document the project outcomes and share best practice and data with the field.

Examples include:

National standards of cleanliness for the NHS
NHS Menu and Recipe Books
Sold on Health

The majority of publications are available in hard copy from The Stationery Office Ltd (TSO):

The Stationery Office Publications Centre
PO Box 276
London
SW8 5DT
Telephone: 0870 600 5522
Fax: 0870 600 5533
<http://www.tso-nhse.co.uk>

Publication lists and selected downloadable publications can be found on our website:

<http://www.nhsestates.gov.uk>

For further information please contact our Information Centre:

e-mail: nhs.estates@doh.gsi.gov.uk

tel: 0113 254 7070



Published by The Stationery Office and available from:

The Stationery Office

(mail, fax and telephone orders only)

PO Box 29, Norwich NR3 1GN General enquiries/Telephone orders 0870 600 5522

Fax orders 0870 600 5533

www.thestationeryoffice.com

The Stationery Office Bookshops

123 Kingsway, London WC2B 6PQ 020 7242 6393 Fax 020 7242 6394

68–69 Bull Street, Birmingham B4 6AD 0121 236 9696 Fax 0121 236 9699

33 Wine Street, Bristol BS1 2BQ 0117 926 4306 Fax 0117 929 4515

9–21 Princess Street, Manchester M60 8AS 0161 834 7201 Fax 0161 833 0634

16 Arthur Street, Belfast BT1 4GD 028 9023 8451 Fax 028 9023 5401

The Stationery Office Oriel Bookshop, 18–19 High Street, Cardiff CF1 2BZ

029 2039 5548 Fax 029 2038 4347

71 Lothian Road, Edinburgh EH3 9AZ 0870 606 5566 Fax 0870 606 5588

The Stationery Office's Accredited Agents

(see Yellow Pages)

and through good booksellers

